

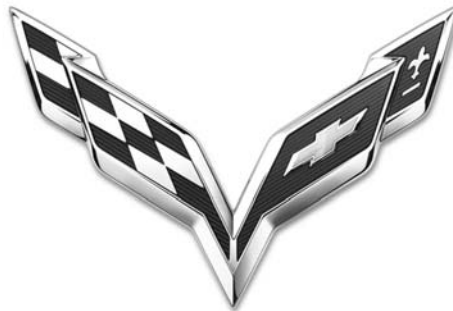

CHEVROLET.



CORVETTE

Owner Manual

Contents

Introduction	2
In Brief	5
Keys, Doors, and Windows	23
Seats and Restraints	52
Storage	86
Instruments and Controls	90
Lighting	133
Infotainment System	139
Climate Controls	145
Driving and Operating	150
Vehicle Care	202
Service and Maintenance	283
Technical Data	290
Customer Information	295
Index	297

Introduction



The names, logos, emblems, slogans, vehicle model names, and vehicle body designs appearing in this manual including, but not limited to, GM, the GM logo, CHEVROLET, the CHEVROLET Emblem, CORVETTE, the CORVETTE Emblem, CORVETTE STINGRAY and the STINGRAY Emblem are trademarks and/or service marks of General Motors LLC, its subsidiaries, affiliates, or licensors.

This manual describes features that may or may not be on the vehicle because of optional equipment that was not purchased on the vehicle, model variants, country specifications, features/applications that may not be available in your region or changes subsequent to the printing of this owner manual.

Refer to the purchase documentation relating to your specific vehicle to confirm the features.

Keep this manual in the vehicle for quick reference.

Using this Manual

To quickly locate information about the vehicle, use the Index in the back of the manual. It is an alphabetical list of what is in the manual and the page number where it can be found.

Danger, Warning, and Caution

Warning messages found on vehicle labels and in this manual describe hazards and what to do to avoid or reduce them.

Danger

Danger indicates a hazard with a high level of risk which will result in serious injury or death.

Warning

Warning indicates a hazard that could result in injury or death.

Caution

Caution indicates a hazard that could result in property or vehicle damage.





A circle with a slash through it is a safety symbol which means “Do Not,” “Do not do this,” or “Do not let this happen.”

Symbols

The vehicle has components and labels that use symbols instead of text. Symbols are shown along with the text describing the operation or

information relating to a specific component, control, message, gauge, or indicator.

 : Shown when the owner's manual has additional instructions or information.

 : Shown when the service manual has additional instructions or information.

 : Shown when there is more information on another page — “see page.”

Vehicle Symbol Chart

Here are some additional symbols that may be found on the vehicle and what they mean. For more information on the symbol, refer to the Index.

 : Airbag Readiness Light

 : Air Conditioning

 : Antilock Brake System (ABS)

 : Audio Steering Wheel Controls

 : Brake System Warning Light

 : Charging System

 : Cruise Control

 : Do Not Puncture

 : Do Not Service

 : Engine Coolant Temperature

 : Exterior Lamps

 : Flame/Fire Prohibited

 : Fog Lamps

 : Fuel Gauge

 : Fuses

 : Headlamp Main/Dipped-Beam Changer

 : LATCH System Child Restraints

 : Malfunction Indicator Lamp

 : Oil Pressure

 : Power

 : Remote Vehicle Start

 : Safety Belt Reminders

 : Tyre Pressure Monitor

 : Traction Control/Active Handling System

 : Under Pressure

 : Windscreen Washer Fluid

In Brief

Instrument Panel

Instrument Panel	6
------------------------	---

Initial Drive Information

Initial Drive Information	8
Remote Keyless Entry (RKE) System	8
Remote Vehicle Start	8
Door Locks	9
Boot Release	10
Windows	11
Seat Adjustment	11
Memory Features	12
Heated and Ventilated Seats ...	13
Safety Belts	13
Passenger Sensing System ...	14
Mirror Adjustment	14
Steering Wheel Adjustment ...	15
Interior Lighting	15
Exterior Lighting	15
Windscreen Wiper/Washer	16
Climate Controls	17
Transmission	18

Vehicle Features

Infotainment System	19
Steering Wheel Controls	19
Cruise Control	19

Driver Information

Centre (DIC)	19
Curb View Camera	20
Rear Vision Camera (RVC)	20
Power Outlets	20
Roof Panel	20
Convertible	20

Performance and Maintenance

Traction Control/Electronic Stability Control	21
Tyre Pressure Monitor	21
Engine Oil Life System	22
Car Wash Guidelines	22
Driving for Better Fuel Economy	22

Instrument Panel

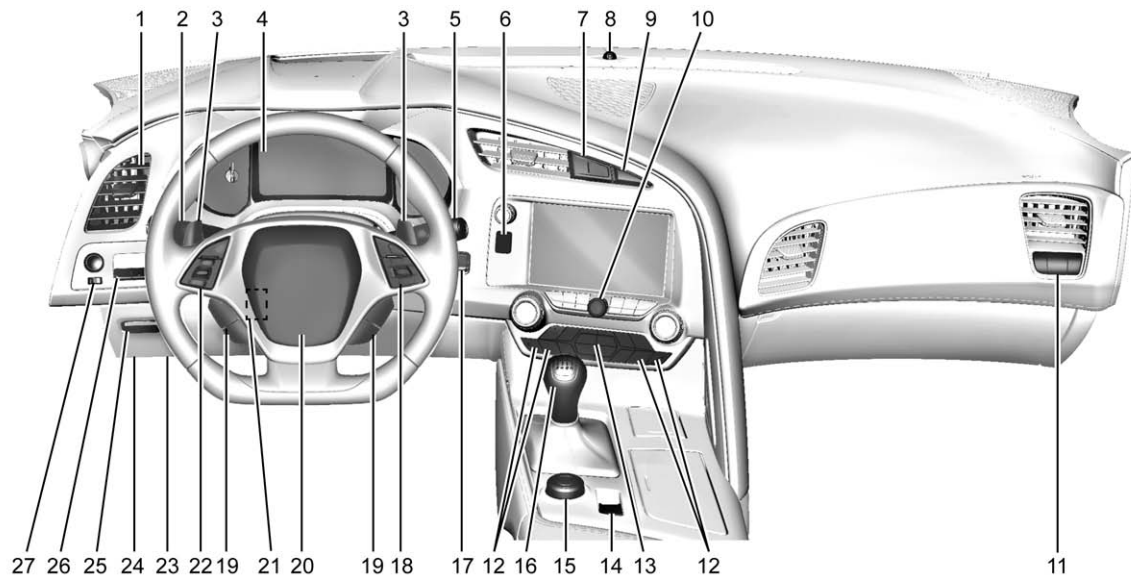

1. *Air Vents* ⇨ 148.
2. *Indicator Lever*. See *Indicator and Lane-Change Signals* ⇨ 136.
Exterior Lamp Controls ⇨ 133.
3. *Manual Shift Paddles* (If Equipped). See *Manual Mode* ⇨ 176.
Active Rev Match Paddles (If Equipped). See *Active Rev Match* ⇨ 181.
4. *Instrument Cluster* ⇨ 95.
5. *Windscreen Wiper/Washer* ⇨ 91.
6. *Instrument Panel Storage Button*. See *Instrument Panel Storage* ⇨ 86.
7. *Passenger Airbag Status Indicator*. See *Passenger Sensing System* ⇨ 68.
8. *Light Sensor*. See *Automatic Headlamp System* ⇨ 135.
9. *Hazard Warning Flashers* ⇨ 136.
10. *Infotainment* ⇨ 139.
11. *Passenger Temperature Control*. See *Dual Automatic Climate Control System* ⇨ 145.
Passenger Heated and Ventilated Seat Controls (If Equipped). See *Heated and Ventilated Front Seats* ⇨ 56.
12. *Driver and Redundant Passenger Heated and Ventilated Seat Controls* (If Equipped). See *Heated and Ventilated Front Seats* ⇨ 56.
13. *Dual Automatic Climate Control System* ⇨ 145.
14. *Electric Handbrake* ⇨ 182.
15. *MODE SELECT Knob*. See *Competitive Driving Mode* ⇨ 190.
16. *Shift Lever* (Manual Shown). See *Automatic Transmission* ⇨ 175 or *Manual Gearbox* ⇨ 179.
17. *Keyless Ignition*. See *Ignition Positions* ⇨ 167.
18. *Bluetooth Controls*. See *Steering Wheel Controls* ⇨ 91.
19. *Voice Recognition Controls*. See *Steering Wheel Controls* ⇨ 91.
20. *Driver Information Centre (DIC) Controls*. See *Driver Information Centre (DIC)* ⇨ 111.
21. *Steering Wheel Controls* ⇨ 91.
22. *Horn* ⇨ 91.
23. *Steering Wheel Adjustment* ⇨ 91 (Out of View).
24. *Cruise Control* ⇨ 193.
25. *Bonnet Release* (Out of View). See *Bonnet* ⇨ 207.
26. *Data Link Connector (DLC)* (Out of View). See *Malfunction Indicator Lamp (Check Engine Light)* ⇨ 104.
27. *Hatch/Boot Release Button*. See *Hatch (Boot)* ⇨ 34.
Intrusion and Inclination Sensors Disable Switch. See *Vehicle Alarm System* ⇨ 36.
28. *Head-Up Display Controls* (If Equipped). See *Head-Up Display (HUD)* ⇨ 113.
29. *Power Mirrors* ⇨ 39.

Initial Drive Information

This section provides a brief overview about some of the important features that may or may not be on your specific vehicle.

For more detailed information, refer to each of the features which can be found later in this owner manual.

Remote Keyless Entry (RKE) System

The Keyless Access system allows for vehicle entry when the transmitter is within range. See *Remote Keyless Entry (RKE) System Operation* ⇨ 25.

The RKE transmitter is used to lock and unlock the doors and may work up to 60 m (197 ft) away from the vehicle.







With Remote Start and Convertible Top Shown, Others Similar

Press the button to remove the key. The key can be used to open the vehicle and hatch/trunk if power to the vehicle is lost. See *Hatch (Boot)* ⇨ 34.

 : Press to unlock the driver door. Press again within five seconds to unlock both doors.

 : Press to lock both doors.

 HOLD : Press and hold to release the hatch/boot.

 : If equipped, press and release  and then immediately press and hold  continuously to open the convertible top all the way. Release the button to stop movement. This button will only open the convertible top.

See *Convertible Top* ⇨ 46.



 : Press and release once to initiate vehicle locator. Press and hold for three seconds to sound the panic alarm. Press again or start the vehicle to stop the panic alarm.

See *Keys* ⇨ 23 and *Remote Keyless Entry (RKE) System Operation* ⇨ 25.

Remote Vehicle Start

If equipped, the engine can be started from outside of the vehicle.

Starting the Vehicle

1. Press and release  on the RKE transmitter.
2. Immediately press and hold  for at least four seconds or until the indicator lamps flash.

3. Start the vehicle normally after entering.

When the vehicle starts, the parking lights will turn on.

Remote start can be extended.



Canceling a Remote Start

To cancel a remote start, do one of the following:

- Press and hold  until the parking lamps turn off.
- Turn on the hazard warning lights.
- Turn the vehicle on and then off.

See *Remote Vehicle Start* ⇨ 29.

Door Locks

To lock or unlock a door from the outside, press  or  on the Remote Keyless Entry (RKE) transmitter.

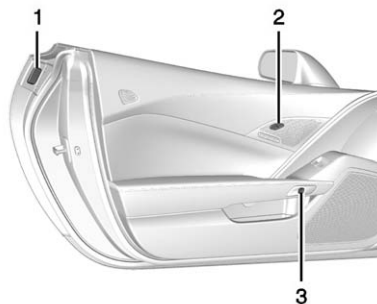

Driver Door

1. Door Handle Sensor
2. Power Door Lock Switch
3. Door Latch Button

For Keyless Access, hold the RKE transmitter within 1 m (3 ft) of the door handle. Grip and press the door handle sensor (1). See *Remote Keyless Entry (RKE) System Operation* ⇨ 25. This feature can be programmed. See *Vehicle Personalisation* ⇨ 127.

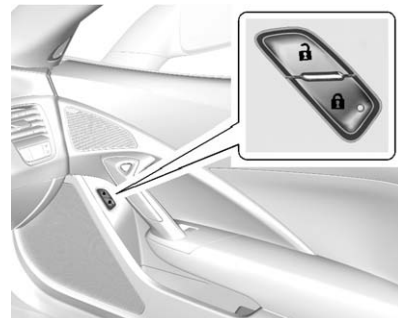

Passenger Door

To lock or unlock a door from the inside, use the power door lock switch.

 : Press to lock the doors.

 : Press to unlock the doors.

To open a door from the inside, press the door lock button.

The fuel door is also locked and unlocked using these features.

See *Power Door Locks* ⇨ 32.

Loss of Vehicle Electrical Power

If the vehicle has lost battery power, open the driver door manually.

From Inside the Vehicle

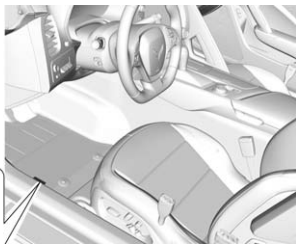

Pull the door release handle.

From Outside the Vehicle

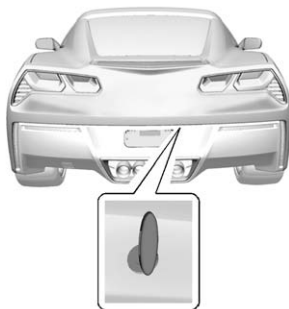

Use the key to open the hatch/boot.

From Inside the Hatch/Boot

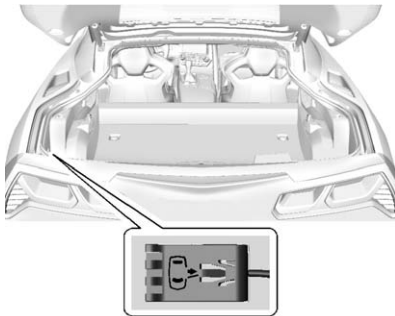



Pull the manual door release handle.

Boot Release

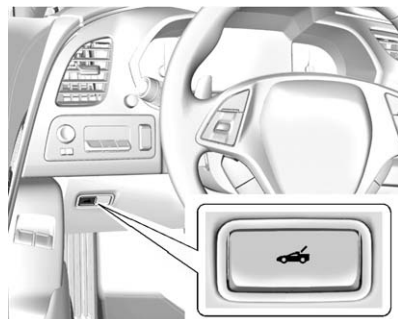
The vehicle must be off, or stationary with the parking break set, in order to release the hatch/boot. See *Electric Handbrake* ⇨ 182.



- Press .
- Press and hold  HOLD on the Remote Keyless Entry (RKE) transmitter. See *Remote Keyless Entry (RKE) System* ⇨ 24.

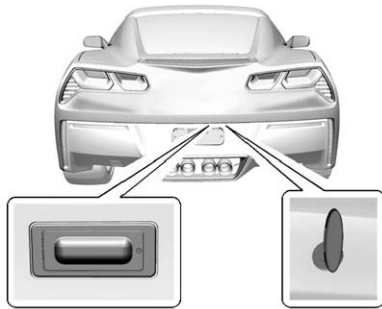

- Press the hatch/boot release touch pad with the RKE transmitter within range or use the key in the key cylinder. See *Remote Keyless Entry (RKE) System* ⇨ 24. See *Keys* ⇨ 23.

See *Hatch (Boot)* ⇨ 34.

Windows



Pull up or press down on the switch to raise or lower the window. See *Power Windows* ⇨ 41.

Retained Accessory Power (RAP) allows the power windows to operate when the ignition is off. See *Retained Accessory Power (RAP)* ⇨ 171.

Seat Adjustment

Power Seats

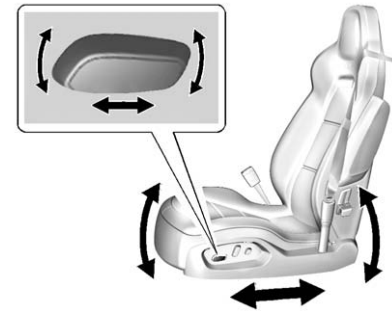

To adjust the seat:

- Move the seat forward or rearward by sliding the control forward or rearward.
- Raise or lower the front part of the seat cushion by moving the front of the control up or down.
- Raise or lower the seat by moving the rear of the control up or down.

See *Power Seat Adjustment* ⇨ 53.

Lumbar and Bolster Adjustment

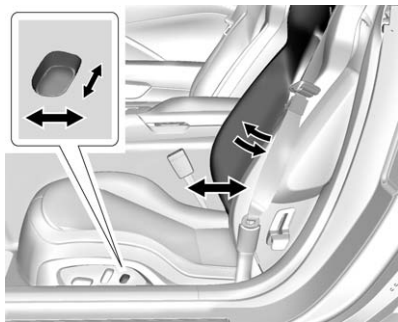

To adjust the lumbar or bolster support, if equipped:

- Press and hold the control forward to increase or rearward to decrease lumbar support.
- Press and hold the control upward to increase or downward to decrease the side bolster support.

See *Lumbar Adjustment* ⇨ 53.

Reclining Seat Backrests

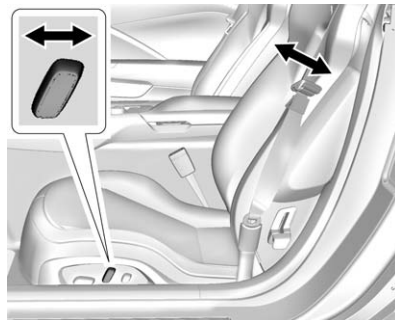

To adjust the seat back:

- Tilt the top of the control rearward to recline.
- Tilt the top of the control forward to raise.

See *Reclining Seat backrests* ⇨ 54.

Memory Features



If equipped, the 1, 2, SET, and  (Exit) buttons on the driver door are used to manually store and recall memory settings for the driver seat, outside mirrors, and power tilt and telescoping steering column.

When Auto Memory Recall is enabled in the personalisation menu, positions previously stored to memory buttons 1 and 2 are recalled when the ignition is changed from OFF to ON/RUN or ACC/ACCESSORY.

When Easy Exit Options is enabled in the personalisation menu, the seats will move rearward when the ignition is changed to OFF and driver door is opened within a short time.

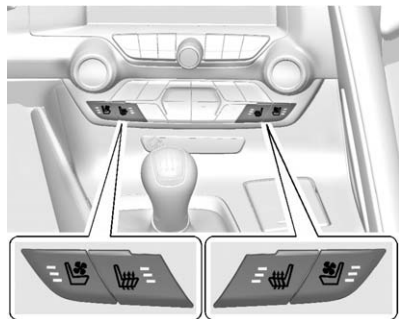

See *Memory Seats* ⇨ 54 and *Vehicle Personalisation* ⇨ 127.

Heated and Ventilated Seats





Driver and Passenger Controls

If equipped, the driver buttons are on the centre stack. To operate, the ignition must be on.

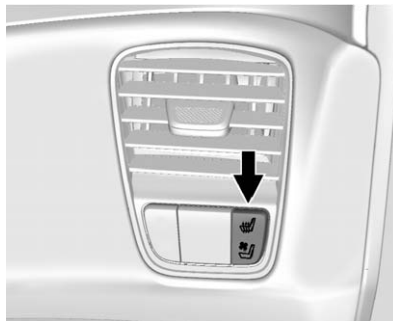
Press  or  on the left side of the climate control panel to ventilate or heat the driver seat. A ventilated seat has a fan that pulls or pushes air through the seat. The air is not cooled.



Passenger Controls

The passenger buttons are also on the right-hand side of the instrument panel under the air vent. Press  or  to heat or ventilate the passenger seat. The driver can also turn on or off the passenger heated and ventilated seats using the buttons on the right side of the climate control panel.

For driver and passenger controls, press the button once for the highest setting. With each press of the button, the seat will change to the next lower setting, and then to the off setting. The indicator lights show three for the highest setting and one for the lowest. If the heated seats are on high, the level may automatically be lowered after approximately 30 minutes.

See *Heated and Ventilated Front Seats* ⇨ 56.

Safety Belts

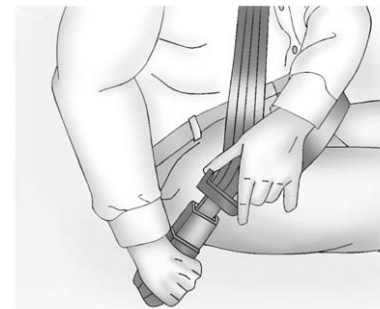

Refer to the following sections for important information on how to use safety belts properly:

- *Safety Belts* ⇨ 58.
- *How to Wear Safety Belts Properly* ⇨ 59.
- *Lap-Shoulder Belt* ⇨ 60.
- *ISOFIX Child Restraint Systems* ⇨ 83

Passenger Sensing System



The passenger sensing system will turn off the front outboard passenger frontal airbag under certain conditions. No other airbag

is affected by the passenger sensing system. See *Passenger Sensing System* ⇨ 68.

The passenger airbag status indicator lights on the instrument panel when the vehicle is started. See *Passenger Airbag Status Indicator* ⇨ 102.

Mirror Adjustment

Exterior Mirrors

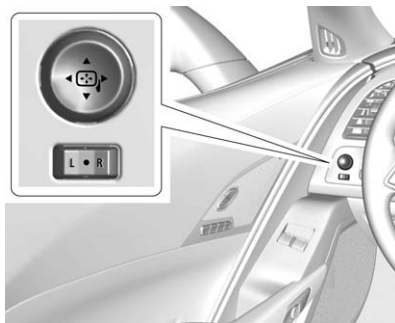

To adjust mirrors:

1. Press L (Left) or R (Right) to select the mirror.

2. Press the control pad to adjust the mirror.
3. Return the switch to the centre to deselect the mirror.

See *Power Mirrors* ⇨ 39.

If the vehicle has the memory feature, a preferred mirror position can be stored. See *Memory Seats* ⇨ 54.

To fold, pull the mirror toward the vehicle. Push the mirror outward, to return it to the original position.

Interior Mirror

Adjustment

Adjust the rearview mirror for a clear view of the area behind the vehicle.

Automatic Dimming Rearview Mirror

The mirror automatically reduces the glare of the headlamps from behind. The dimming feature comes on when the vehicle is started.

See *Automatic Dimming Rearview Mirror* ⇨ 40.

Steering Wheel Adjustment

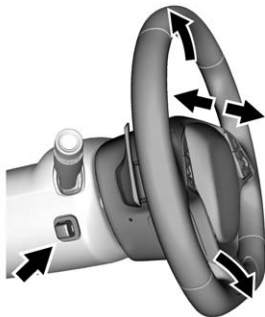

Press the control to move the tilt and telescoping steering wheel up and down or forward and rearward.

Both the tilt and telescoping steering column positions can be stored with your memory settings. See *Memory Seats* ⇨ 54.

Do not adjust the steering wheel while driving.

Interior Lighting

Interior Light Control

The knob for this feature is on the left side of the instrument panel. Turn clockwise or anti-clockwise to brighten or dim the lights. Turn the knob completely clockwise to turn the interior lights on.

Courtesy Lamps

When any door or the tailgate/boot is opened, the interior lamps will come on.

To turn the courtesy lamps on or off, turn the instrument panel brightness knob completely clockwise or anti-clockwise.

Reading Lamps



The reading lamps are in the overhead console. The lamps go on when a door is opened. When the doors are closed, press the lamp buttons to turn on each lamp.

For more information on interior lighting, see *Instrument Panel Illumination Control* ⇨ 137.

Exterior Lighting





The exterior lamp control is on the indicator lever.



There are four positions.

☹ : Turns off all lamps.

AUTO : Sets the exterior lamps to automatic mode. AUTO mode turns the exterior lamps on and off depending on how much light is available outside the vehicle.

 : Turns on the parking lamps including all lamps, except the headlamps.

 : Turns on the headlamps together with the parking lamps and instrument panel lights.

 : Turn the band to  and release it to turn the rear fog lamps on and off.

See:

- *Exterior Lamp Controls* ⇨ 133
- *Indicator and Lane-Change Signals* ⇨ 136

Windscreen Wiper/Washer





The window wiper/washer lever is on the right side of the steering column.

With the ignition in ACC/ACCESSORY or ON/RUN/START, move the stalk to select the wiper speed.

HI : Use for fast wipes.

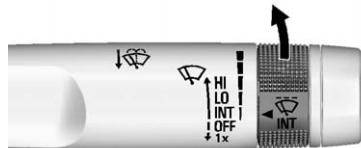
LO : Use for slow wipes.



INT : Move the lever up to INT for intermittent wipes, then turn the  INT band up for more frequent wipes or down for less frequent wipes.

OFF : Use to turn the wipers off.

1X : For a single wipe, briefly move the stalk down. For several wipes, hold the stalk down.

 : Pull the stalk toward you to spray windscreen washer fluid and activate the wipers.

See *Windscreen Wiper/Washer* ⇨ 91.

Climate Controls

The heating, cooling, and ventilation for the vehicle can be controlled with this system.

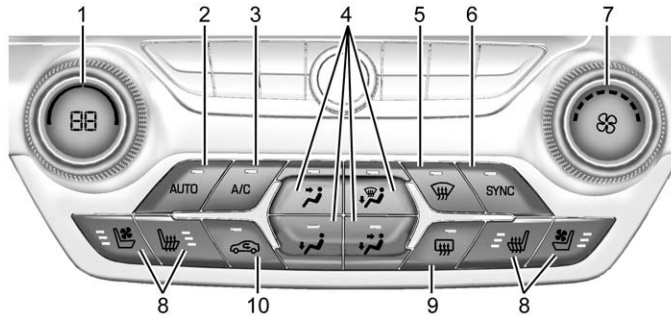

- | | |
|---|---|
| <ol style="list-style-type: none"> 1. Driver Temperature Control 2. AUTO (Automatic Operation) 3. A/C (Air Conditioning) 4. Air Delivery Modes 5. Defrost 6. SYNC | <ol style="list-style-type: none"> 7. Fan Control 8. Driver and Passenger Redundant Heated and Ventilated Front Seat Controls 9. Rear Window Demister 10. Recirculation |
|---|---|



Passenger Temperature Control

The passenger temperature control is below the passenger side air vent.

See *Dual Automatic Climate Control System* ⇨ 145.

Transmission

Manual Paddle Shift (Automatic Transmission)

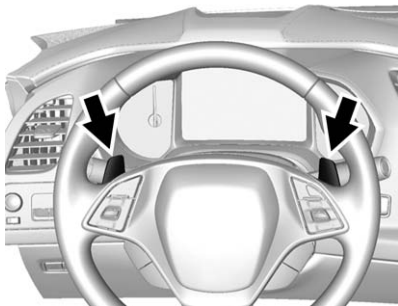

The Manual Paddle Shift system can be used in D (Drive) or M (Manual Mode). The system is activated by pushing the left paddle to downshift and the right paddle to upshift. The current gear will be displayed in the instrument cluster, or the Head-Up Display (HUD), if equipped.

The Manual Paddle Shift system will not allow either an upshift or a downshift, if the vehicle speed is too fast or too slow, nor will it allow a start from 3 (Third) or higher gear.

See *Manual Mode* ⇨ 176.

Active Rev Match (Manual Gearbox)

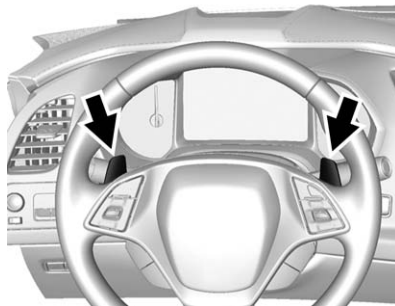

Active Rev Match (ARM) aids in smoother shifting by matching the engine speed to the next selected gear. The system is activated and deactivated by pressing either of the paddles marked REV MATCH on the steering wheel. See *Active Rev Match* ⇨ 181.

Shift Indicator



The shift indicator illuminates in the instrument cluster when a gear shift is recommended for best fuel economy. When the arrow is pointed up, an upshift is recommended. When the arrow is pointed down, a downshift is recommended. The number displayed with the arrow indicates the recommended gear.

Vehicle Features

Infotainment System

See the infotainment manual for information on the radio, audio players, phone, and navigation system. It also includes information on settings.

Steering Wheel Controls

The infotainment system can be operated by using the steering wheel controls. See "Steering Wheel Controls" in the infotainment manual.

Cruise Control

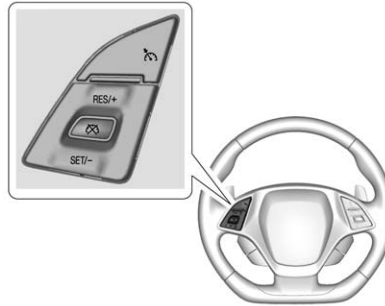

 : Press to turn cruise control on or off. A white indicator comes on in the instrument cluster when cruise is turned on.

RES/+ : If there is a set speed in memory, press briefly to resume to that speed or press and hold to accelerate. If cruise control is already active, use to increase vehicle speed.

SET/- : Press briefly to set the speed and activate cruise control. If cruise control is already active, use to decrease vehicle speed.



 : Press to disengage cruise control without erasing the set speed from memory.

See *Cruise Control* ⇨ 193.

Driver Information Centre (DIC)

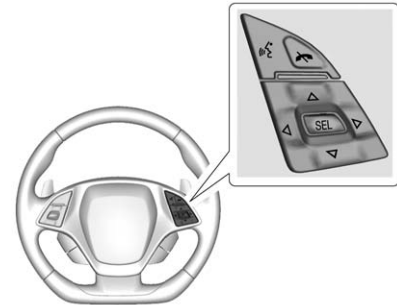
The DIC display is in the instrument cluster. It shows the status of many vehicle systems.



 or  : Press to move up or down in a list.

◀ or ▶ : Press ◀ to open application menus on the left. Press ▶ to open interaction menus on the right.

SEL : Press to open a menu or select a menu item. Press and hold to reset values on certain screens.

See *Driver Information Centre (DIC)* ⇨ 111.

Curb View Camera

If equipped, a view of the area in front of the vehicle displays to aid with parking and low-speed manoeuvres.

See "Curb View Camera" under *Assistance Systems for Parking or Backing* ⇨ 196.

Rear Vision Camera (RVC)

If equipped, RVC displays a view of the area behind the vehicle on the centre stack display when the vehicle is shifted into R (Reverse) to aid with parking and low-speed reversing manoeuvres.

See *Assistance Systems for Parking or Backing* ⇨ 196.

Power Outlets

Use the accessory power outlet to plug in electrical equipment, such as a mobile phone or MP3 player.

There are three accessory power outlets:

- Inside the centre console storage compartment.
- In front of the cupholder.
- In the rear compartment.

Lift the cover to access and replace when not in use.

See *Power Outlets* ⇨ 93.

Roof Panel

If equipped with a removable roof panel, there are three release handles. Two are at the front of the roof panel and one is at the rear of the roof panel. See "Removing the Roof Panel" under *Roof Panel* ⇨ 43.

Help may be needed to remove the roof panel. Always store the roof panel properly in the rear storage compartment.

For more information:

- See "Storing the Roof Panel" under *Roof Panel* ⇨ 43.
- See "Installing the Roof Panel" under *Roof Panel* ⇨ 43.

Convertible



If equipped, the convertible top can be automatically opened and closed. For step-by-step instructions, see *Convertible Top* ⇨ 46.





Performance and Maintenance

Traction Control/ Electronic Stability Control

The traction control system limits wheel spin. The system turns on automatically every time the vehicle is started.

StabiliTrak is a computer controlled system that helps the driver maintain directional control of the vehicle in difficult driving conditions. This is accomplished by selectively applying any one of the vehicle's brakes. The system turns on automatically every time the vehicle is started.

- To turn off traction control, press and release the TCS/StabiliTrak  button on the centre console.  illuminates in the instrument cluster.

- To turn off both traction control and StabiliTrak, press and hold the TCS/StabiliTrak  button, until the Traction Off light  and the StabiliTrak OFF light  illuminate in the instrument cluster.
- Press and release the TCS/StabiliTrak  button again to turn on both systems.

See *Traction Control/Electronic Stability Control* ⇨ 185.

The vehicle has Driver Mode Control and Performance Traction Management. See *Driver Mode Control* ⇨ 187 and *Competitive Driving Mode* ⇨ 190.

Tyre Pressure Monitor

This vehicle may have a Tyre Pressure Monitor System (TPMS).



The low tyre pressure warning light alerts to a significant loss in pressure of one of the vehicle's tyres. If the warning light comes on, stop as soon as possible and inflate the tyres to the recommended pressure shown on the Tyre and Loading Information label. See *Vehicle Load Limits* ⇨ 162. The warning light will remain on until the tyre pressure is corrected.

The low tyre pressure warning light may come on in cool weather when the vehicle is first started, and then turn off as the vehicle is driven. This may be an early indicator that the tyre pressures are getting low and the tyres need to be inflated to the proper pressure.

The TPMS does not replace normal monthly tyre maintenance. Maintain the correct tyre pressures.

See *Tyre Pressure Monitor System* ⇨ 251.

Engine Oil Life System

The engine oil life system calculates engine oil life based on vehicle use and displays CHANGE ENGINE OIL SOON message when it is time to change the engine oil and filter. The oil life system should be reset to 100% only following an oil change.

Dry Sump Engine Break-In Oil Change

If equipped with a dry sump engine, the initial oil and filter change must be performed at 800 km/500 mi. Follow the engine oil life system for every oil change thereafter.

Resetting the Oil Life System

After you change the oil, the oil life system will need to be reset. See your dealer for service.

See *Engine Oil Life System* ⇨ 216.

Car Wash Guidelines

Caution

Some automatic car washes can cause damage to the vehicle, wheels, or convertible top, if equipped. Automatic car washes are not recommended, due to lack of clearance for the undercarriage and/or wide rear tyres and wheels. See "Washing the Vehicle" under *Exterior Care* ⇨ 273

Driving for Better Fuel Economy

Driving habits can affect fuel mileage. Here are some driving tips to get the best fuel economy possible:

- Avoid fast starts and accelerate smoothly.
- Brake gradually and avoid abrupt stops.
- Avoid idling the engine for long periods of time.

- When road and weather conditions are appropriate, use cruise control.
- Always follow posted speed limits or drive more slowly when conditions require.
- Keep vehicle tyres properly inflated.
- Combine several trips into a single trip.
- Replace the vehicle's tyres with the same TPC Spec number moulded into the tyre's sidewall near the size.
- Follow recommended scheduled maintenance.
- Select Eco mode for improved fuel economy. This will result in better Active Fuel Management (AFM) operation. See *Active Fuel Management*[®] ⇨ 173.
- For recommended shift speeds, see *Manual Gearbox* ⇨ 179.

Premium Fuel

Use the recommended fuel. See *Fuel* ⇨ 197.

Keys, Doors, and Windows

Keys and Locks

Keys	23
Remote Keyless Entry (RKE) System	24
Remote Keyless Entry (RKE) System Operation	25
Remote Vehicle Start	29
Door Locks	30
Power Door Locks	32
Delayed Locking	32
Automatic Door Locks	33
Lockout Protection	33

Doors

Hatch (Boot)	34
--------------------	----

Vehicle Security

Vehicle Security	36
Vehicle Alarm System	36
Anti-theft Locking System	38
Immobiliser	38
Immobiliser Operation	38

Exterior Mirrors

Convex Mirrors	39
Power Mirrors	39

Folding Mirrors	40
Heated Mirrors	40
Automatic Dimming Mirror	40
Reverse Tilt Mirrors	40

Interior Mirrors

Interior Rearview Mirrors	40
Automatic Dimming Rearview Mirror	40

Windows

Windows	41
Power Windows	41
Sun Visors	43

Roof

Roof Panel	43
Convertible Top	46

Keys and Locks

Keys

Warning

Leaving children in a vehicle with a Remote Keyless Entry (RKE) transmitter is dangerous and children or others could be seriously injured or killed. They could operate the power windows or other controls or make the vehicle move. The windows will function with the RKE transmitter in the vehicle, and children or others could be caught in the path of a closing window. Do not leave children in a vehicle with an RKE transmitter.

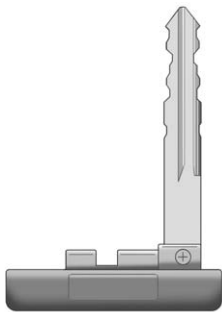

The key inside the RKE transmitter can be used to open the vehicle and tailgate/boot if power to the vehicle is lost. See *Hatch (Boot)* ⇨ 34.



With Remote Start and Convertible Top Shown, Others Similar

Press the button near the bottom of the RKE transmitter to remove the key. Never pull the key out without pressing the button.

This vehicle has a Keyless Access system with pushbutton start. See *Ignition Positions* ⇨ 167 for information on starting the vehicle.

If it becomes difficult to turn the key, inspect the key blade for debris.

Remote Keyless Entry (RKE) System

See *Declaration of Conformity* ⇨ 295.

If there is a decrease in the RKE operating range:

- Check the distance. The transmitter may be too far from the vehicle.
- Check the location. Other vehicles or objects may be blocking the signal.
- Check the transmitter's battery. See "Battery Replacement" later in this section.
- If the transmitter is still not working correctly, see your dealer or a qualified technician for service.

Remote Keyless Entry (RKE) System Operation

The Keyless Access system allows for vehicle entry when the transmitter is within 1 m (3 ft). See “Keyless Access Operation” later in this section.

The RKE transmitter functions may work up to 60 m (197 ft) away from the vehicle.

Other conditions can affect the performance of the transmitter. See *Remote Keyless Entry (RKE) System* ⇨ 24.



With Remote Start and Convertible Top Shown, Without Similar

🔒 (Lock) : Press to lock both doors. The indicator lamp indicators may flash and/or the horn may sound to indicate locking. Press twice within five seconds for deadbolt locking. See *Vehicle Personalisation* ⇨ 127.

If the driver door is open when **🔒** is pressed is enabled through the vehicle personalisation, all doors will lock and then the driver door will immediately unlock. See *Vehicle Personalisation* ⇨ 127. If the passenger door is open when **🔒** is pressed, both doors lock.

Pressing **🔒** may also arm the theft-deterrent system. See *Vehicle Alarm System* ⇨ 36.

When the doors are locked, the fuel door is also locked.



🔓 (Unlock) : Press to unlock the driver door and deadbolt. Press again within five seconds to unlock both doors. When remotely unlocking the vehicle at night, the headlights and reversing lamps will come on for about 30 seconds to light your approach to the vehicle and when the door is open. The indicators may flash to indicate unlocking.

Pressing **🔓** will disarm the theft-deterrent system. See *Vehicle Alarm System* ⇨ 36.



When the doors are unlocked, the fuel door is also unlocked.

🌀 (Remote Start) : If equipped, press and release **🔒** and then immediately press and hold **🌀** for at least four seconds to start the

engine from outside the vehicle using the RKE transmitter. See *Remote Vehicle Start* ⇨ 29.

 **(Vehicle Locater/Panic Alarm)** : Press and release to initiate vehicle locater. The exterior lamps flash and the horn chirps three times. Press and hold  for three seconds to sound the panic alarm. The horn sounds and the indicator lamps flash until  is pressed again or the vehicle is started.

 **HOLD (Hatch/Boot)** : Press and hold to release the hatch/trunk. If the engine is running, the shift lever must be in P (Park) for an automatic transmission. For a manual transmission, the shift lever must be in Neutral with the parking brake set.

 **(Convertible Top)** : If equipped, press and release , then immediately press and hold  continuously to open the convertible top all the way. Release

the button to stop movement. This button will only open the convertible top.

Convertible Top

- Do not try to start the vehicle while using the RKE transmitter to open the convertible top. Release the RKE transmitter and ENGINE START/STOP button and wait a few seconds before starting the vehicle normally.
- The passive door unlock feature may not operate properly while using the RKE transmitter to open the convertible top.

Keyless Access Operation

This vehicle has the Keyless Access system that lets you unlock and unlatch the doors and access the boot without removing the RKE transmitter from your pocket, purse, briefcase, etc. The RKE transmitter must be within 1 m (3 ft) of the door being opened. There will be a touch pad on the inside of the door handles.

The Keyless Access system can be programmed to unlock both doors on the first door handle sensor press from the driver door. See *Vehicle Personalisation* ⇨ 127.

Keyless Unlocking

Press the door handle sensor to unlock and open the doors if the RKE transmitter is within range. See *Vehicle Personalisation* ⇨ 127.

Passive Locking

Keyless Access will lock several seconds after all doors are closed if the vehicle is off and at least one transmitter has been removed or none remain in the vehicle.

The fuel door will also lock at this time.



The indicators may flash and the horn may chirp to indicate that the vehicle is not deadbolt locked.

If other electronic devices interfere with the RKE transmitter signal, the vehicle may not detect the RKE transmitter inside the vehicle. If passive locking is enabled, the doors may lock with the RKE

transmitter inside the vehicle. Do not leave the RKE transmitter in an unattended vehicle.

To customise whether the doors automatically lock when exiting the vehicle, see *Vehicle Personalisation* ⇨ 127.

Temporary Disable of Passive Locking Feature

Temporarily disable the passive locking by pressing and holding  on the interior door switch with a door open for at least four seconds, or until three chimes are heard. Passive locking will then remain disabled until  on the interior door is pressed, or until the vehicle is switched on.

To customise the doors to automatically lock when exiting the vehicle, see *Vehicle Personalisation* ⇨ 127.

Remote Left in Vehicle Alert

When the vehicle is turned off and a remote is left in the vehicle, the horn will chirp three times after both doors are closed. To turn on or off see *Vehicle Personalisation* ⇨ 127.

Keyless Boot Opening



Press the release touch pad to open the boot if the RKE transmitter is within 1 m (3 ft).

Programming Transmitters to the Vehicle

Only RKE transmitters programmed to this vehicle will work. If a transmitter is lost or stolen, a

replacement can be purchased and programmed through your dealer. When the replacement transmitter is programmed to this vehicle all remaining transmitters must also be programmed. Any lost or stolen transmitters will no longer work once the new transmitter is programmed. Each vehicle can have up to eight transmitters programmed to it. See your dealer to program transmitters to this vehicle.

Starting the Vehicle with a Low Transmitter Battery

If the transmitter battery is weak or if there is interference with the signal, the DIC may display a NO REMOTE DETECTED or NO REMOTE KEY WAS DETECTED PLACE KEY IN TRANSMITTER POCKET THEN START THE VEHICLE. message when you try to start the vehicle. See *Key and Lock Messages* ⇨ 120.

Caution

When replacing the battery, do not touch any of the circuitry on the transmitter. Static from your body could damage the transmitter.

To start the vehicle:

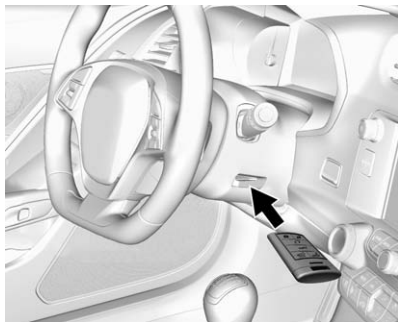

1. Place the transmitter in the steering column transmitter pocket with the chrome buttons facing up and the base toward the passenger side.

2. With the vehicle in P (Park) or N (Neutral), press the brake pedal and the ENGINE START/STOP button.

Replace the transmitter battery as soon as possible.

Battery Replacement

Warning

Make sure that you dispose of old batteries in accordance with environmental protection regulations to help protect the environment and your health.

Caution

When replacing the battery, do not touch any of the circuitry on the transmitter. Static from your body could damage the transmitter.

Replace the battery if the REPLACE BATTERY IN REMOTE KEY message displays in the DIC.



1. Press the button near the bottom of the transmitter and pull the key out.



- Use the oval base of the key blade to separate the two halves of the transmitter.

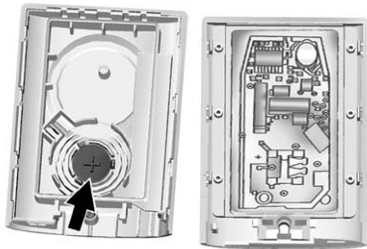

- Remove the old battery. Do not use a metal object.
- Insert the new battery on the back housing, positive side facing down. Replace with a CR2032 or equivalent battery.
- Align the key release button and snap the transmitter back together.

Remote Vehicle Start

If equipped, this feature allows the engine to be started from outside the vehicle.

Ⓞ (Remote Vehicle Start) : This button will be on the RKE transmitter if the vehicle has remote start.

The climate control system will use the previous settings during a remote start. The rear window demister may come on during remote start based on cold ambient conditions. The rear demist indicator light does not come on during remote start.

During a remote start, the heated or ventilated seats, if equipped, may turn on automatically. See *Heated and Ventilating Front Seats* ⇨ 56.

Laws in some local communities may restrict the use of remote starters. For example, some laws may require a person using remote start to have the vehicle in view. Check local regulations for any requirements.

If the vehicle is low on fuel, do not use the remote start feature. The vehicle may run out of fuel.

The RKE transmitter range may be less while the vehicle is running.

Other conditions can affect the performance of the transmitter. See *Remote Keyless Entry (RKE) System* ⇨ 24.

Starting the Engine Using Remote Start

- Press and release **🔒** on the RKE transmitter.
- Immediately press and hold **Ⓞ** for at least four seconds or until the indicator lamps flash. The lamps flash to confirm the request to remote start the vehicle has been received.

During the remote start, the doors will be locked and the parking lamps will remain on as long as the engine is running.

The engine will shut off after 10 minutes unless a time extension is done.

- To drive, have the RKE transmitter in the vehicle, press the brake pedal, and then start the vehicle.

Extending Engine Run Time

The engine run time can also be extended by another 10 minutes, if during the first 10 minutes Steps 1–2 are repeated while the engine is still running. An extension can be requested, 30 seconds after starting. This provides a total of 20 minutes.

The remote start can only be extended once per ignition cycle.

A maximum of two remote starts, or a remote start with an extension, are allowed between ignition cycles.

After two remote starts, the vehicle's ignition must be changed to ON/RUN/START and then back to OFF before the remote start procedure can be used again.

Cancelling a Remote Start

To cancel a remote start, do any of the following:

- Press and hold  until the parking lamps turn off.
- Turn on the hazard warning lights.
- Turn the vehicle on and then back off.

Conditions in Which Remote Start Will Not Work

The remote start will not operate if any of the following occur:

- The ignition is in any mode other than OFF.
- The transmitter is in the vehicle.
- The bonnet is not closed.
- The hazard warning flashers are on.
- There is an emission control system malfunction.
- The engine coolant temperature is too high.
- The oil pressure is low.

- Two remote vehicle starts have already been used.
- The vehicle is not in P (Park).

Door Locks



Warning

Unlocked doors can be dangerous.



- Passengers - especially children - can easily open the doors and fall out of a moving vehicle. When a door is locked it will not open. You increase the chance of being thrown out of the vehicle in a crash if the doors are not locked. So, wear seat belts properly and lock the doors whenever you drive.
- Young children who get into unlocked vehicles may be unable to get out. A child can be overcome by extreme heat and can suffer

(Continued)

Warning (Continued)

permanent injuries or even death from heat stroke. Always lock your vehicle whenever you leave it.

- Outsiders can easily enter through an unlocked door when you slow down or stop your vehicle. Locking your doors can help prevent this from happening.

To lock or unlock from the outside, press  or  on the Remote Keyless Entry (RKE) transmitter.

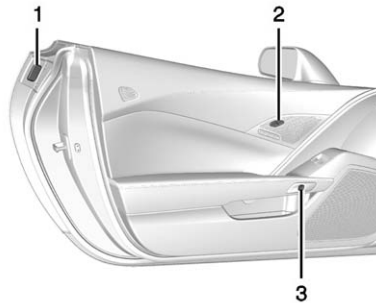

1. Door Handle Sensor
2. Power Door Lock Switch
3. Door Latch Button

For Keyless Access, hold the RKE transmitter within 1 m (3 ft) of the door handle. Grip and press the door handle sensor (1) to open. See *Remote Keyless Entry (RKE) System Operation* ⇨ 25. When the passenger door is opened first, the driver door will also unlock. To program this feature, see *Vehicle Personalisation* ⇨ 127.

To lock or unlock from the inside, use the power door lock switch (2). See *Power Door Locks* ⇨ 32.

To open a door from the inside, press the door latch button (3).

If the vehicle has lost battery power, the driver door can be opened manually:

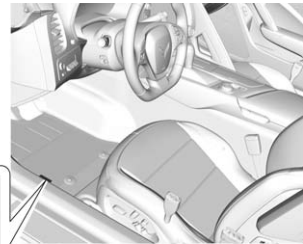

From inside the vehicle, pull the door release handle.

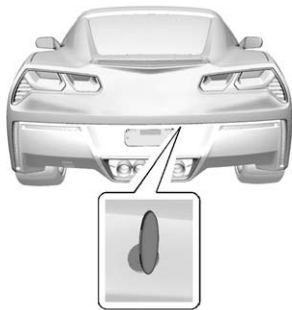

From outside the vehicle, use the key to open the hatch/boot. See *Keys* ⇨ 23.

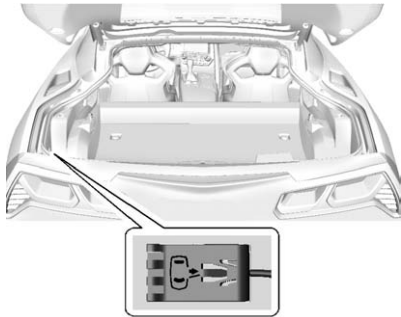

Pull the manual door release handle.



Power Door Locks

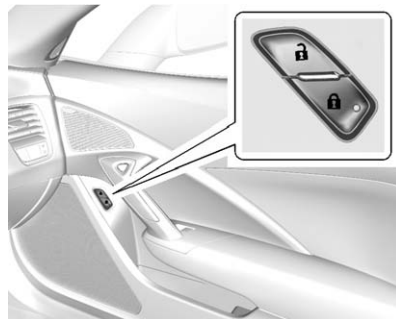

Driver Door



Passenger Door

To lock or unlock the doors and fuel door from inside the vehicle, press  or  on a power door lock switch. The indicator light in the switch will illuminate when the door is locked.



Delayed Locking

This feature delays the actual locking of the doors until five seconds after all doors are closed.

Delayed locking can only be turned on when the Unlocked Door Anti Lockout feature has been turned off.

When  is pressed on the power door lock switch with the door open, a chime will sound three times indicating that delayed locking is active.

The doors will then lock automatically five seconds after all doors are closed. If a door is reopened before five seconds have elapsed, the five-second timer will reset once all the doors are closed again.

Press  on the door lock switch again, or press  on the RKE transmitter, to override this feature and lock the doors immediately.

Delayed locking can be programmed through the Driver Information Centre (DIC). See *Vehicle Personalisation* ⇨ 127.

Automatic Door Locks

When the doors are closed, the ignition is on, and the shift lever is moved out of P (Park) for automatic transmissions, or the vehicle speed is above 13 km/h (8 mph) for manual gearboxes, the doors will lock.

To unlock the doors:

- Press  on a power door lock switch.
- If equipped with an automatic transmission, shift the transmission into P (Park).
- If equipped with a manual gearbox, remove the key from the ignition when parked.

Lockout Protection

If the vehicle is in ACC/ACCESSORY or ON/RUN/START, and the power door lock switch is pressed with the driver door open, the doors will lock and only the driver door will unlock.

If the vehicle is off and Unlocked Door Anti Lockout is turned on, the driver door is open, and door locking is requested using a door lock switch or the RKE transmitter, both doors will lock and only the driver door will unlock. The Unlocked Door Anti Lockout feature can be turned on or off using the vehicle personalisation menus.

See *Vehicle Personalisation* ⇨ 127.

Lockout protection can be manually overridden with the driver door open by pressing and holding  on the power door lock switch.

Doors

Hatch (Boot)

Warning

Exhaust gases can enter the vehicle if it is driven with the tailgate, hatch/boot open, or with any objects that pass through the seal between the body and the hatch/boot or tailgate. Engine exhaust contains carbon monoxide (CO) which cannot be seen or smelled. It can cause unconsciousness and even death.

If the vehicle must be driven with the tailgate or hatch/boot open:

- Close all of the windows.
- Fully open the air outlets on or under the instrument panel.
- Adjust the climate control system to a setting that brings in only outside air and set the fan speed to the

(Continued)

Warning (Continued)

highest setting. See “Climate Control Systems” in the Index.

- If the vehicle is equipped with a power tailgate, disable the power tailgate function.

For more information about carbon monoxide, see *Engine Exhaust* ⇨ 174.



Hatch/Boot Release

For automatic transmissions, the vehicle must be in P (Park).

For manual transmissions, the vehicle must be off or stationary with the parking brake set. See *Electric Handbrake* ⇨ 182.

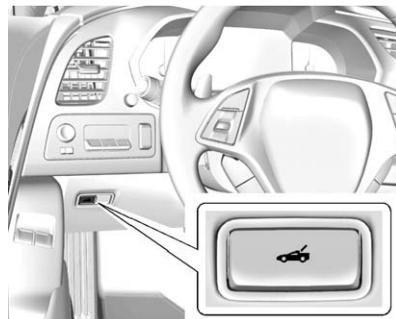
To release the hatch/boot:



- Press .
- Press and hold  **HOLD** on the Remote Keyless Entry (RKE) transmitter. See *Remote Keyless Entry (RKE) System* ⇨ 24.

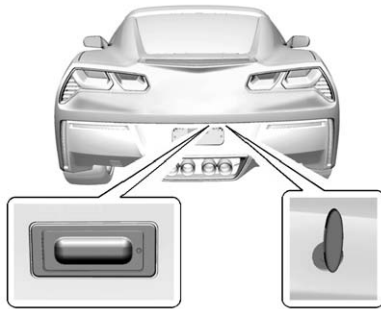

Press the hatch/boot release touch pad with the RKE transmitter within range or use the key in the key cylinder. See *Keys* ⇨ 23.

Hatch/Boot Closing

Caution

Do not store heavy or sharp objects in the rear storage compartments located in the hatch/boot area. The objects could damage the underside of the hatch/boot.

The tailgate/boot has an electric latch that will latch automatically. Use the pull cup to close the hatch/boot with light force.

Emergency Boot Release Handle (Convertible)

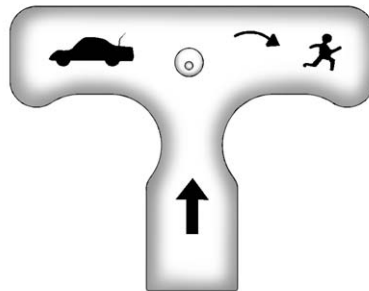

There is a glow-in-the-dark emergency boot release handle on the boot lid. This handle will glow following exposure to light. Pull the release handle to open the boot from the inside.

After use, return to the stored position.

Caution

Do not use the emergency boot release handle as a tie-down or anchor point when securing items in the boot as it could damage the handle.

Vehicle Security

This vehicle has theft-deterrent features; however, they do not make the vehicle impossible to steal.

Vehicle Alarm System

This vehicle has an anti-theft alarm system.



The indicator light, on the instrument panel near the windscreen, indicates the status of the system.



Off : Alarm system is disarmed.

On Solid : Vehicle is secured during the delay to arm the system.

Fast Flash : Vehicle is unsecured. A door, the bonnet, or the hatch/boot is open.

Slow Flash : Alarm system is armed.

Arming the Alarm System

1. Turn off the vehicle.
2. Lock the vehicle in one of three ways:
 - Use the RKE transmitter.
 - Use the Keyless Access system.
 - With a door open, press  on the interior of the door.
3. After 30 seconds the alarm system will arm, and the indicator light will begin to slowly flash indicating the alarm system is operating. Pressing  on the RKE transmitter a second time will bypass the 30-second delay and immediately arm the alarm system.

The vehicle alarm system will not arm if the doors are locked with the key.

If the driver door is opened without first unlocking with the RKE transmitter, the horn will chirp and the lights will flash to indicate pre-alarm. If the vehicle is not started, or the door is not unlocked by pressing  on the RKE transmitter during the 10-second pre-alarm, the alarm will be activated.

The alarm will also be activated if the passenger door, the hatch/boot, or the bonnet is opened without first disarming the system. When the alarm is activated, the indicators flash and the horn sounds for about 30 seconds. The alarm system will then re-arm to monitor for the next unauthorised event.

Disarming the Alarm System

To disarm the alarm system or turn off the alarm if it has been activated, do one of the following:

- Press  on the RKE transmitter.

- Unlock the vehicle using the Keyless Access system.
- Start the vehicle.

To avoid setting off the alarm by accident:

- Lock the vehicle after all occupants have left the vehicle and both doors are closed.
- Always unlock a door with the RKE transmitter or use the Keyless Access system.

Unlocking the driver door with the key will not disarm the system or turn off the alarm.

How to Detect a Tamper Condition

If  is pressed on the transmitter and the horn chirps three times, a previous alarm occurred while the system was armed.

If the alarm has been activated, a message will appear on the DIC. See *Security Messages* ⇨ 124.

Power Sounder, Inclination Sensor and Intrusion Sensor

In addition to the standard theft-deterrent system features, this system also has an inclination sensor and intrusion sensor.

The power sounder provides an audible alarm which is different from the vehicle's horn. It has its own power source, and can sound an alarm when the vehicle's battery is compromised.

The inclination sensor can set off the alarm if it senses movement of the vehicle, such as a change in vehicle orientation.

The intrusion sensor monitors the vehicle interior, and can activate the alarm if it senses unauthorised entry into the vehicle's interior. Do not allow passengers or pets to remain in the vehicle when the intrusion sensor is activated.

Before arming the theft-deterrent system and activating the intrusion sensor:

- Make sure both doors and windows are completely closed.
- Secure any loose items such as sunshades.
- Make sure there are no obstructions blocking the sensors.

Intrusion and Inclination Sensors Disable Switch

It is recommended that the intrusion and inclination sensors be deactivated if pets are left in the vehicle or the vehicle is being transported.

With the vehicle turned off, press  to the right of the tailgate/boot release button. The indicator light will come on momentarily, indicating that these sensors have been disabled for the next alarm system arming cycle.

Anti-theft Locking System

The vehicle is equipped with a deadbolt locking feature in addition to the standard door locks.

The deadbolt is engaged whenever you press  on the RKE transmitter twice within five seconds with all doors closed and the vehicle off.

The deadbolt lock can also be engaged with the Keyless Access system. See “Keyless Access Operation” under *Remote Keyless Entry (RKE) System Operation* ⇨ 25.

When the doors are secured with the deadbolt, they cannot be unlocked or opened using the controls or handles inside the vehicle.

Press  on the transmitter once to open the deadbolt and unlock the driver door. Pressing the button again within five seconds will unlock all of the doors.

Immobiliser

See *Declaration of Conformity* ⇨ 295.

Immobiliser Operation

The vehicle has a passive theft-deterrent system.



The security light comes on in the instrument cluster if there is a problem with arming or disarming the theft-deterrent system. This light also comes on briefly when the engine is started.

The system is automatically armed when the ignition is turned off.

The immobilisation system is disarmed when the ignition is placed in ACC/ACCESSORY or ON/RUN/START and a valid transmitter is found in the vehicle.

You do not have to manually arm or disarm the system.

The system has one or more RKE transmitters that are matched to an immobiliser control unit in the vehicle. Only a correctly matched RKE transmitter starts the vehicle. The vehicle may not start if the RKE transmitter is damaged.

If the engine does not start and the security light comes on, there may be a problem with the immobiliser system. Press the ENGINE START/STOP button again.

If the vehicle does not start and the RKE transmitter appears to be undamaged, try another RKE transmitter. Or, place the transmitter in the transmitter pocket. See “NO REMOTE DETECTED” under *Key and Lock Messages* ⇨ 120. Check the fuse. See *Fuses* ⇨ 238. If the engine still does not start with the other transmitter, the vehicle needs service. If the engine does start, the first transmitter may be faulty. See your dealer or have a new RKE transmitter programmed to the vehicle.

The immobiliser system can learn new or replacement RKE transmitters. Up to eight RKE transmitters can be programmed for the vehicle. To program additional transmitters, see “Programming Transmitters to the Vehicle” under *Remote Keyless Entry (RKE) System Operation* ⇨ 25.

Do not leave the key or device that disarms or deactivates the theft-deterrent system in the vehicle.

Exterior Mirrors

Convex Mirrors

Warning

A convex mirror can make things, like other vehicles, look farther away than they really are. If you cut too sharply into the right lane, you could hit a vehicle on the right. Check the inside mirror or glance over your shoulder before changing lanes.

The driver and passenger side mirrors are convex shaped. A convex mirror's surface is curved so more can be seen from the driver seat.

Power Mirrors

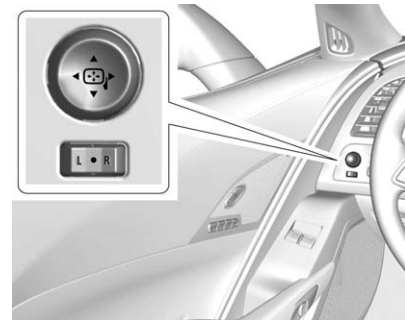

To adjust the mirrors:

1. Press L (Left) or R (Right) to select a mirror.
2. Press the control pad to adjust the mirror.
3. Return the switch to the centre to deselect the mirror.

If the vehicle has the memory feature, a preferred mirror position can be stored. See *Memory Seats* ⇨ 54.

Folding Mirrors

To fold, pull the mirror toward the vehicle. Push the mirror outward to return it to the original position.

Heated Mirrors

For vehicles with heated mirrors:

 **(Rear Window Demister)** :

Press to heat the mirrors.

See “Rear Window Demister” under *Dual Automatic Climate Control System* ⇨ 145.

Automatic Dimming Mirror

The driver outside mirror automatically adjusts for the glare of headlamps from behind.

Reverse Tilt Mirrors

If equipped with memory seats, the passenger and/or driver mirror tilts to a preselected position when the vehicle is in R (Reverse). This allows the kerb to be seen when parallel parking.

The mirror(s) return to the original position when:

- The vehicle is shifted out of R (Reverse), or remains in R (Reverse) for about 30 seconds.
- The ignition is turned off.
- The vehicle is driven in R (Reverse) above a set speed.

To turn this feature on or off, see *Vehicle Personalisation* ⇨ 127.

Interior Mirrors

Interior Rearview Mirrors

Adjust the rearview mirror for a clear view of the area behind the vehicle.

Do not spray glass cleaner directly on the mirror. Use a soft towel dampened with water.

Automatic Dimming Rearview Mirror

The rearview mirror automatically dims to reduce the glare of the headlamps from behind. This feature comes on when the vehicle is started.

Windows

Warning

Never leave a child, a helpless adult, or a pet alone in a vehicle, especially with the windows closed in warm or hot weather. They can be overcome by the extreme heat and suffer permanent injuries or even death from heat stroke.



Power Windows

Warning

Leaving children in a vehicle with the Remote Keyless Entry (RKE) transmitter is dangerous for many reasons; children or others could be badly injured or even killed. They could operate the power windows or other controls or even make the vehicle move. The windows will function with the RKE transmitter in the vehicle and they could be seriously injured or killed if caught in the path of a closing window. Do not leave the RKE transmitter in a vehicle with children.



Press the switch to the first detent to lower the window. Pull to the first detent to raise the window. Release to stop at the desired position.

If windows are operated repeatedly in short intervals, window operation is disabled for a short time.

Retained Accessory Power (RAP) allows the use of the power windows when the ignition is off. See *Retained Accessory Power (RAP)* ⇨ 171.

Express Window Operation

This feature allows the window to automatically open or close fully.

- To activate express-down, press the switch fully to the second detent and release.
- To activate express-up, pull the switch fully to the second detent and release.
- To stop window movement, press or pull the switch briefly.

Obstacle Detection

This feature is active during express-up movements in ON/RUN/START, or when the engine is off and RAP is active. Obstacle detection also works with RAP when the switch is held up.

If the window encounters an object during closing, it will stop and open to a predetermined distance.

Conditions such as severe cold or ice may cause the window to auto-reverse. The window will return to normal operation once the condition or object is removed.

If conditions prevent a window from closing and the window continues to auto-reverse, it is possible to close the window while in ON/RUN/START by holding the window switch in the first or second detent until the window is closed.

Window Operation with Convertible Top

Windows automatically lower fully when the convertible top is lowered or raised. See *Convertible Top* ⇨ 46. To raise the windows, pull the switch to the second detent and release.

Window Indexing

Indexing automatically lowers the window a small amount when the door is opened. When the door is closed, the window will raise to its full up position. If either window does not index properly, it could be due to loss of power. Before returning to the dealer for service, perform the window indexing reset procedure.

Window Indexing and Express-Up Reset

Window indexing may be required if the vehicle battery has been recharged or disconnected, or is not working. Express-up and the convertible top will not function until the windows are reset. After battery power is restored, a message displays in the Driver Information Centre. See *Driver Information Centre (DIC)* ⇨ 111.

Once power is restored:

1. Close the doors.
2. Start the vehicle.
3. Hold the window switch up to the fully closed position.

Sun Visors

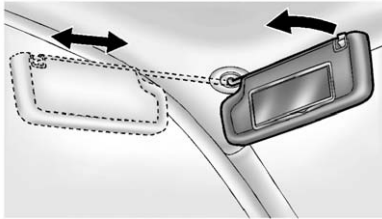

Pull the sun visor down to block glare. Detach the sun visor from the centre mount to pivot to the side window or, if equipped, extend along the rod.

Roof

Roof Panel

If equipped with a removable roof panel, use the following procedures to remove or install it.

Caution

If a roof panel is dropped or rested on its edges, the roof panel, paint, and/or weatherstripping may be damaged. Always place the roof panel in the stowage receivers after removing it from the vehicle.

Removing the Roof Panel

Warning

Do not remove a roof panel while the vehicle is moving. The panel could fall into the vehicle and strike an occupant and cause you to lose control. It could also fly off

(Continued)

Warning (Continued)

and strike another vehicle. Remove the roof panel only when the vehicle is parked.

It may be necessary to have help removing the roof panel.

To remove:

1. Shift an automatic transmission into P (Park) or a manual transmission into 1 (First) or R (Reverse).
2. Turn the ignition off and set the handbrake.
3. Lower both sun visors.
4. Open the rear tailgate/boot and remove any items that may interfere with proper storage of the roof panel.
5. Lower the windows.

There are two release handles on the front and one release handle on the rear of the roof panel.

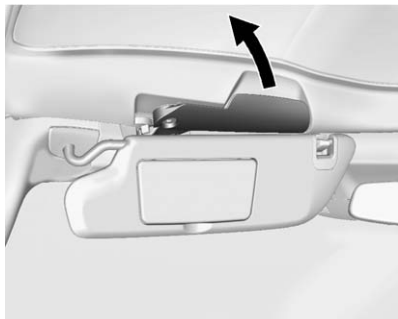

6. To unlock the front release handles, pull them outward, turning fully.

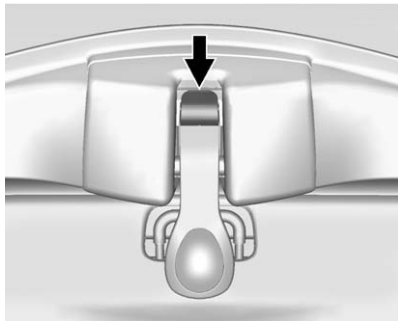

7. Press the button on the front of the rear release handle to unlock it. The catch lever will open.
8. Stand on one side of the vehicle and, if necessary, have someone stand on the other side. Together, carefully lift the front edge of the roof panel up and forward. Avoid dropping the rear edge downward.
9. When the roof panel is loose, grasp it as close to the centre as possible and lift it away from the vehicle.

Storing the Roof Panel

Warning

If a roof panel is not stored properly, it could be thrown about the vehicle in a crash or sudden manoeuvre. People in the vehicle could be injured. Always use the stowage receivers.

Caution

Dirt, dust, or other contaminants on the removable roof panel or cargo shade could cause damage to the finish of the roof panel if it is stored under the shade. Remove the cargo shade when storing the roof in the rear compartment.

1. Turn the roof panel so that the front edge of the panel is facing the front of the vehicle.

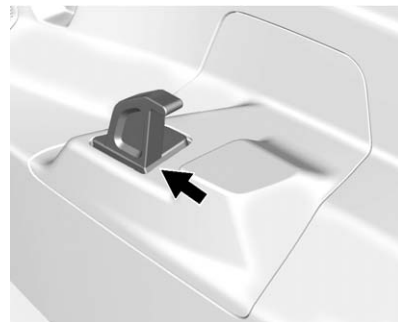

2. Insert the front of the roof panel so that the indents lie on top of the receivers.

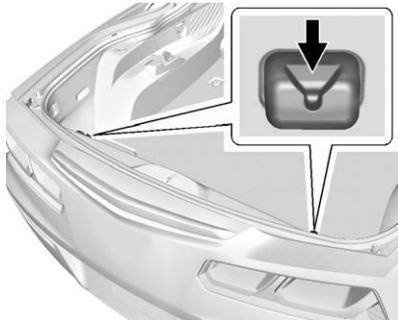

3. Line up the rear roof panel pins so that they drop into the receivers on the back of the storage area.
4. Press down firmly to seat the pins in the rear receivers.

Installing the Roof Panel

Warning

An improperly attached roof panel may fall into or fly off the vehicle. You or others could be injured. After installing the roof panel, always check that it is firmly attached by pushing up on the underside of the panel. Check now and then to be sure the roof panel is firmly in place.

Caution

Installing the roof with the release handles in the closed position could cause damage to the interior trim. Always move handles to the open position when installing the roof.

It is easier if two people install the roof panel.

1. Shift an automatic transmission into P (Park). Shift a manual transmission into 1 (First) or R (Reverse).
2. Turn the ignition off and set the handbrake.
3. To remove the roof panel, pull up on the rear edge and remove it from the storage area.
4. Carefully place the roof panel over the top of the vehicle.

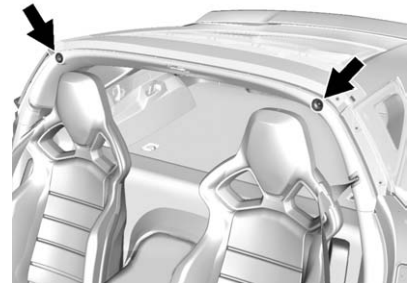

5. Position the rear edge of the roof panel next to the weatherstrip on the back of the roof opening. Then align and fit

the pins at the rear of the roof panel inside the openings in the rear overhead weatherstrip. Gently lower the front edge of the roof panel to the front of the roof opening.

6. Check that the weatherstripping on each side of the roof panel is under the panel.
7. Make sure the front release handles are in the full open position.
8. Push the roof firmly downward to engage the pins.
9. Turn the front release handles inward so that they fully catch to the closed position. It is critical that the handles fully latch.



10. Push back and up on the rear release handle to insert the hook in the loop.
11. Push and pull the roof panel up and down and side to side to ensure the roof panel is securely installed.

Maintaining the Roof Panel

Caution

Using glass cleaner on a painted roof panel could damage the panel. The repairs would not be

(Continued)

Caution (Continued)

covered by the vehicle warranty. Do not use glass cleaner on the painted roof panel.

When cleaning, removing, and/or storing the roof panel:

- Flush with water to remove dust and dirt, then dry the panel.
- Do not use abrasive cleaning materials on the panel.

Convertible Top

If equipped with a convertible top, review the following before operating:

Warning

While opening or closing the convertible top, people can be injured by the moving parts of the tonneau cover or convertible top. Maintain visual contact with the top while it is being operated.

Caution

Follow these guidelines when operating the convertible top or damage can occur:

- Remove all items from the roof, boot lid, or tonneau cover before operating.
- Remove all objects from the boot that may contact the convertible top when it is operated.
- Do not leave the vehicle with the convertible top open.
- Do not exceed 50 km/h (31 mph) until the top has completely closed or opened.
- Do not open or close the top while driving in high wind conditions.
- Do not operate the convertible top multiple times in a short period of

(Continued)

Caution (Continued)

time without starting the engine to avoid draining the vehicle battery.

- Do not open or store the convertible top when it is dirty or wet. This could result in stains, mildew, or other damage.
- Only store the vehicle with the top fully closed.

Opening the Convertible Top — Instrument Panel Switch

1. Remove all objects from the top of the tonneau cover and forward of the partition. Place the partition in the rear storage area in the upright position. Fasten both sides of the partition to the posts just below the tonneau cover. See *Rear Storage* ⇨ 87.
2. Close the boot.
3. Start the vehicle or place it in ACC/ACCESSORY.

4. When possible, operate the convertible top when the vehicle is stopped. The top can be operated while driving below 50 km/h (31 mph) and will stop if that speed is exceeded. The top operation will take approximately 25 seconds. Make sure the top operation can be completed before that speed is reached.

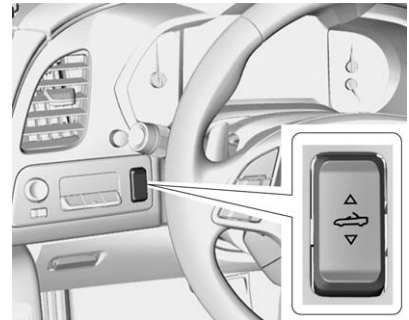





5. Press and hold the bottom of . The windows will automatically lower.

6. After the convertible top is completely open, a chime sounds and a DIC message displays. Release the switch.



If the radio is on, the sound may be muted for a brief time due to a new audio system equalisation being loaded.

Opening the Convertible Top — RKE Transmitter

1. Make sure the vehicle is off.
2. The boot partition must already be in place and the boot closed.
3. Keep visual contact with the vehicle. Press and release  on the RKE transmitter and then quickly press and hold .
4. Hold  until the top is completely opened and the exterior lamps flash. A chime will sound.

If the top stops before it has completely opened, press  and then press  again.

If the top still stops opening try the following:

- Move closer to the vehicle.
- Hold  until the operation is complete.
- Interference from other RKE transmitters or devices may interrupt the operation. Press  and then  again. If the top still does not open use the convertible switch in the vehicle.

The convertible top cannot be closed using the RKE transmitter.

See *Rear Storage* ⇨ 87.

See *Remote Keyless Entry (RKE) System Operation* ⇨ 25.

Closing the Convertible Top

1. Make sure the sun visor mirror covers are closed and the sun visors are stored in the center mount position.

2. Remove all objects from the top of the tonneau cover and forward of the partition. Place the partition in the rear storage area in the upright position. Fasten both sides of the partition to the posts just below the tonneau cover. See *Rear Storage* ⇨ 87.
3. Close the boot.
4. Start the vehicle or place it in ACC/ACCESSORY.
5. When possible, operate the convertible top when the vehicle is stopped. The top can be operated while driving below 50 km/h (31 mph) and will stop if that speed is exceeded. The top operation will take approximately 25 seconds. Make sure the top operation can be completed before that speed is reached.

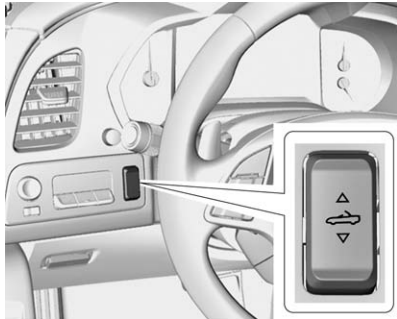

6. Press and hold the top of . The windows will automatically lower.
7. After the convertible top is completely closed, a chime sounds and a DIC message displays. Release the switch. Raise the windows if needed.

If the radio is on, the sound may be muted for a brief time due to a new audio system equalisation being loaded.

Troubleshooting

Check the following if the convertible top switch  is not operating:

- The ignition should be in ACC/ACCESSORY or ON/RUN/START, or Retained Accessory Power (RAP) should be active.
- The boot lid should be closed and the boot partition in place. A DIC message will display.
- If the ONLY MANUAL OPERATION OF TOP POSSIBLE message is displayed on the DIC, see “Manual Movement of Top” later in this section.
- At cooler outside temperatures, the convertible top may not open. It is possible to close the top down to temperatures of about -20°C (-4°F). A DIC message will display if the top will not open due to low temperature. If necessary, move the vehicle to a heated indoor area to operate the top.

- If the top has recently been cycled repeatedly or left in an intermediate state, it will be temporarily disabled. A DIC message displays. Normal operation will be restored within 10 minutes after the system has cooled.
- If the vehicle battery is low, the power top operation may be disabled. Try to start the vehicle. A DIC message displays.
- If the battery has recently been reconnected or if the vehicle has been jump started, the top may not operate until the power windows have been indexed. Complete the power window indexing procedure. See *Power Windows* ⇨ 41.

See *Convertible Top Messages* ⇨ 117.

Other features may be affected while operating the convertible top:

- The boot can only be opened with the key until the convertible top is completely opened or closed.

- Do not try to start the vehicle while opening the top with the RKE transmitter. A DIC message may display. Release both buttons and wait a few seconds before starting the vehicle normally.
- The passive door unlock feature may not operate properly while using the RKE transmitter to open the convertible top.
- The windows cannot close while the top is moving.
- When driving with the top not fully secured, chimes can be heard above 80 km/h (50 mph).

If the vehicle battery has been disconnected and reconnected, the fuses were pulled or replaced, or a jump start was performed, the TOP NOT SECURE message may display. Press and hold  to open/close the top until this message is cleared.

See *Convertible Top Messages*
⇨ 117.

Partial Top Cycling

If the convertible top operation is stopped before completion, the top will temporarily hold its position. If the ignition is in ACC/ACCESSORY or ON/RUN/START, the top will be held for up to five minutes. If the vehicle is moving or off, the amount of time will vary from a few seconds to about a minute.

Beeps and DIC messages will be displayed before the top will move. When this occurs, immediately finish the convertible top operation by pressing the button again until it completes.

If the top cannot be secured, keep clear of the top components. In some conditions the top may move quickly.

Do not drive with the convertible top in an unsecured position. The top components may move unexpectedly. In some cases the top may not be able to be power operated. If this occurs, follow the DIC messages displayed.

If the tonneau cover is not secured and latched, and the vehicle is moving above 10 km/h (6 mph), the tonneau cover may automatically move to a stable position.

See *Convertible Top Messages*
⇨ 117.

Manual Movement of Top

If the DIC displays the ONLY MANUAL OPERATION OF TOP POSSIBLE message:

1. Press  to either open or close the top. Press the switch in the opposite direction if one does not work.
2. If the top moves, continue pressing the switch in that direction for at least five seconds. The top should then work normally.

If the top does not respond in either direction, use the following procedure to manually adjust the convertible top and tonneau cover if they are retracted but not latched. This requires more than one person.

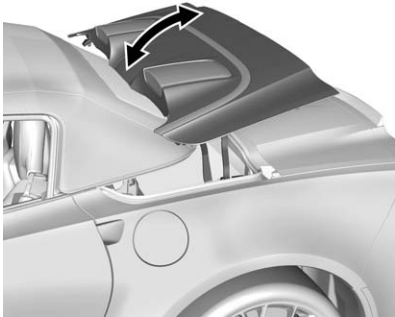

1. On each side of the tonneau cover, lift and pivot rearward into the fully open position.

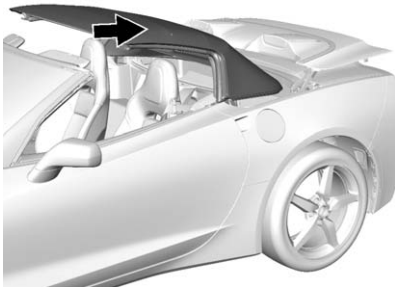

2. Lift and pivot the convertible top rearward into the fully stowed position.

If the convertible top does not operate after this adjustment, close the tonneau cover and take it to your dealer for service.

Cleaning the Convertible Top

The convertible top should be cleaned often. Do not use high-pressure car washes as these may cause water to enter the vehicle.

Hand wash the convertible top in partial shade. Use mild soap, lukewarm water, and a soft sponge. A chamois or cloth may leave lint on the top and a brush can chafe the threads in the top fabric. Do not use detergents, harsh cleaners, solvents, or bleaching agents.

Wet the entire top and let the soap remain on the fabric for a few minutes. Wash evenly to avoid spots or rings. When the top is very dirty, use a mild foam-type cleaner. Thoroughly rinse the entire vehicle, then let the top dry in direct sunlight.

To protect the convertible top:

- Make sure the convertible top is completely dry before lowering it.
- Do not get any cleaner on the vehicle's painted finish; it could leave streaks.

Seats and Restraints

Head Restraints

Head Restraints 52

Front Seats

Power Seat Adjustment 53

Lumbar Adjustment 53

Reclining Seat Backrests 54

Memory Seats 54

Seat-Back Latches 56

Heated and Ventilated Front
Seats 56

Safety Belts

Safety Belts 58

How to Wear Safety Belts
Properly 59

Lap-Shoulder Belt 60

Safety Belt Use During
Pregnancy 62

Safety System Check 62

Safety Belt Care 63

Replacing Safety Belt System
Parts after a Crash 63

Airbag System

Airbag System 64

Where Are the Airbags? 65

When Should an Airbag
Inflate? 66

What Makes an Airbag
Inflate? 67

How Does an Airbag
Restrain? 67

What Will You See after an
Airbag Inflates? 67

Passenger Sensing System ... 68

Servicing the Airbag-Equipped
Vehicle 72

Adding Equipment to the
Airbag-Equipped Vehicle 73

Airbag System Check 73

Replacing Airbag System Parts
after a Crash 74

Child Restraints

Older Children 74

Infants and Young Children 76

Child Restraint Systems 78

Where to Put the Restraint 79

ISOFIX Child Restraint
Systems 83

Securing Child Restraints 83

Head Restraints

The vehicle's front seats have head restraints in the outboard seating positions that cannot be adjusted.

The front seat outboard head restraints are not removable.

Front Seats

Power Seat Adjustment

Warning

You can lose control of the vehicle if you try to adjust a driver seat while the vehicle is moving. Adjust the driver seat only when the vehicle is not moving.

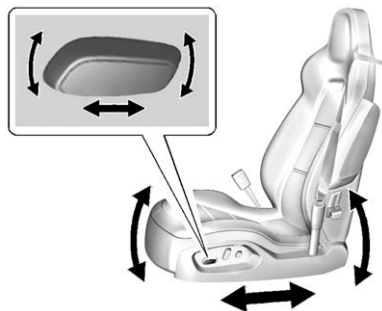

To adjust the seat:

- Move the seat forward or rearward by sliding the control forward or rearward.
- Raise or lower the front part of the seat cushion by moving the front of the control up or down.
- Raise or lower the seat by moving the rear of the control up or down.

To adjust the seatback, see *Reclining Seatbacks* ⇨ 54.

To adjust the lumbar support, see *Lumbar Adjustment* ⇨ 53.

Seat Travel Limit

If a seat is moved all the way to the rear and/or the seatback is reclined so that it makes contact with the carpet, all rearward seat movement will stop. Normal operation of the seat will resume when the seatback is no longer in contact with the carpet. This is normal.

If a seat is folded forward, all rearward or downward seat movement will stop. Normal operation will resume when the seat is returned to an upright position.

Lumbar Adjustment

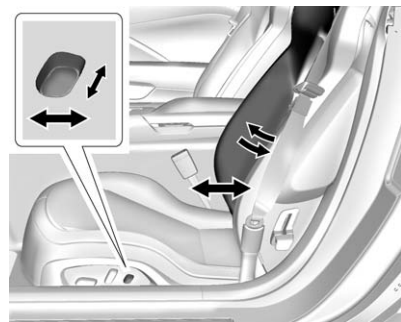

To adjust the lumbar and bolster support (if equipped):

- Press and hold the control forward to increase or rearward to decrease lumbar support.
- If equipped, press and hold the control upward to increase or downward to decrease the side bolster support.

Reclining Seat Backrests

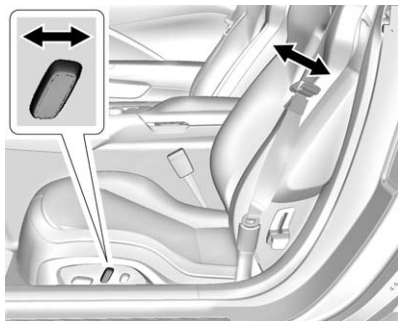

To adjust the seatback:

- Tilt the top of the control rearward to recline.
- Tilt the top of the control forward to raise.

Warning

Sitting in a reclined position when the vehicle is in motion can be dangerous. Even when buckled up, the safety belts cannot do their job.

(Continued)

Warning (Continued)

For proper protection when the vehicle is in motion, have the seatback upright. Then sit well back in the seat and wear the safety belt properly.

Memory Seats



If memory equipped, the 1, 2, SET, and  (Exit) buttons on the driver door are used to manually store and recall memory settings for the driver seat, outside mirrors, and power tilt and telescoping steering column.

Storing Memory Positions

To store positions to the 1 and 2 buttons:

1. Place the ignition in ON/RUN/START or ACC/ACCESSORY.
2. Adjust the driver seat, outside mirrors, and the power tilt and telescoping steering column to the desired driving positions.
3. Press and release SET. A beep will sound.
4. Immediately press and hold 1 until two beeps sound.
5. Repeat Steps 1–4 for a second driver using 2.

To store exit positions and easy exit features, repeat Steps 1–4 using  (Exit) to store your positions for getting out of the vehicle.

Manually Recalling Memory Positions

Press and hold 1, 2, or  to manually recall the previously stored memory positions. Releasing

1, 2, or  before the stored positions are reached stops the recall.

Automatically Recalling Memory Positions (Auto Memory Recall)

If programmed in the vehicle personalisation menu, the Auto (Automatic) Memory Recall feature automatically recalls the current driver's previously stored 1 or 2 position when the ignition is changed from OFF to ON/RUN/START or ACC/ACCESSORY.

See “Auto Memory Recall” under “Comfort and Convenience” in *Vehicle Personalisation* ⇨ 127.

To stop recall movement, press one of the memory, power mirror, or power seat controls, or press the power tilt and telescoping steering column control.

Placing the Ignition in OFF also stops the recall

If the vehicle driver has changed, in some vehicles the Driver ID may be displayed for the first few ignition cycles.

RKE transmitters are not labelled with a number. If your memory seat position is stored to 1 or 2 but this position is not automatically recalling, then store your positions to the other button or switch RKE transmitters with the other driver.

Easy Exit Recall

If programmed on in the vehicle personalisation menu, the easy exit feature recalls the previously stored Exit positions when leaving the vehicle. See “Storing Memory Positions” previously in this section. See also *Vehicle Personalisation* ⇨ 127.

Easy exit recall automatically activates when one of the following occurs:

- The vehicle is turned off and the driver door is opened within a short time.
- The vehicle is turned off with the driver door open.

To stop recall movement, press one of the memory, driver seat, outside mirror, or power tilt and telescoping steering column controls.

Seat Travel Limit

If the seat is folded forward or moved rearward into contact with the carpet, the seat must be returned to an upright position or moved forward off the carpet to regain operation.

Obstructions

If something has blocked the driver seat and/or power tilt and telescoping steering column while recalling a memory position, the recall may stop. Remove the obstruction. Then do one of the following:

- If automatically or manually recalling the stored memory position, press and hold the appropriate manual control for two seconds. Try recalling again by pressing the appropriate memory button.
- If automatically recalling the position, try recalling by opening the driver door and pressing  on the RKE transmitter.

- If recalling the exit position, press and hold the appropriate manual control for the exit feature not recalling for two seconds. Then try recalling the exit position again.

If the memory position is still not recalling, see your dealer for service.

Seat-Back Latches



If equipped, lift the latch to fold a seatback forward.

Warning

If either seatback is not locked, it could move forward in a sudden stop or crash. That could cause injury to the person sitting there. Always push and pull on the seatbacks to be sure they are locked.

To return a seatback to the sitting position, push the seatback rearward. Push and pull on the seat backrest to make sure it is locked in place.

In some vehicles, when the seatback is folded forward, some power seat adjustments may not be available. See *Power Seat Adjustment* ⇨ 53 and *Reclining Seatbacks* ⇨ 54.

Heated and Ventilated Front Seats

Warning

If you cannot feel temperature change or pain to the skin, the seat heater may cause burns. To reduce the risk of burns, people with such a condition should use care when using the seat heater, especially for long periods of time. Do not place anything on the seat that insulates against heat, such as a blanket, cushion, cover, or similar item. This may cause the seat heater to overheat. An overheated seat heater may cause a burn or may damage the seat.

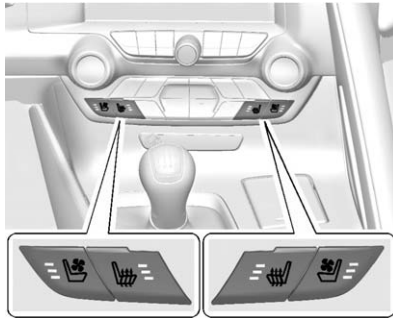

Driver and Redundant Passenger Controls

If equipped, the driver buttons are on the centre stack. To operate, the ignition must be on.

Press or on the left side of the climate control panel to ventilate or heat the driver seat. A ventilated seat has a fan that pulls or pushes air through the seat. The air is not cooled.

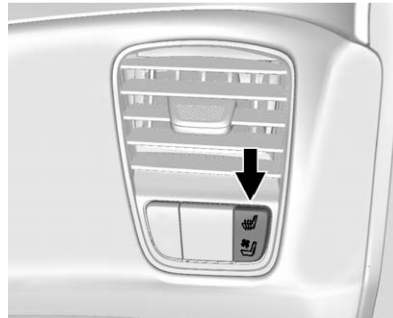

Passenger Controls

The passenger buttons are also on the right side of the instrument panel under the air vent. Press or to heat or ventilate the passenger seat. The driver can also turn on or off the passenger heated and ventilated seats using the buttons on the right side of the climate control panel.

Press the button once for the highest setting. With each press of the button, the seat will change to the next lower setting, and then to the off setting. The indicator lights show three for the highest setting and one for the lowest. If the heated seats are on high, the level may automatically be lowered after approximately 30 minutes.

The passenger seat may take longer to heat up.

Remote Start Heated and Ventilated Seats

During a remote start (if equipped), the heated or ventilated seats can be turned on automatically. When it is cold outside, the heated seats turn on, and when it is hot outside the ventilated seats turn on. The heated or ventilated seats are cancelled when the ignition is turned on. Press the heated or ventilated seat button to use the heated or ventilated seats after the vehicle is started.

The heated or ventilated seat indicator lights do not turn on during a remote start.

The temperature performance of an unoccupied seat may be reduced. This is normal.

The heated or ventilated seats will not turn on during a remote start unless they are enabled in the vehicle personalisation menu. See *Remote Vehicle Start* ⇨ 29 and *Vehicle Personalisation* ⇨ 127.

Safety Belts

This section of the manual describes how to use safety belts properly. It also describes some things not to do with safety belts.

Warning

Do not let anyone ride where a safety belt cannot be worn properly. In a crash, if you or your passenger(s) are not wearing safety belts, injuries can be much worse than if you are wearing safety belts. You can be seriously injured or killed by hitting things inside the vehicle harder or by being ejected from the vehicle. In addition, anyone who is not buckled up can strike other passengers in the vehicle.

It is extremely dangerous to ride in a cargo area, inside or outside of a vehicle. In a collision, passengers riding in these areas are more likely to be seriously injured or killed. Do not allow

(Continued)

Warning (Continued)

passengers to ride in any area of the vehicle that is not equipped with seats and safety belts.

Always wear a safety belt, and check that all passenger(s) are restrained properly too.

This vehicle has indicators as a reminder to buckle the safety belts. See *Safety Belt Reminders* ⇨ 101.

Why Safety Belts Work



When riding in a vehicle, you travel as fast as the vehicle does. If the vehicle stops suddenly, you keep going until something stops you. It could be the windscreen, the instrument panel, or the safety belts!

When you wear a safety belt, you and the vehicle slow down together. There is more time to stop because you stop over a longer distance and, when worn properly, your strongest bones take the forces from the safety belts. That is why wearing safety belts makes such good sense.

Questions and Answers About Safety Belts

Q: Will I be trapped in the vehicle after a crash if I am wearing a safety belt?

A: You *could* be - whether you are wearing a safety belt or not. Your chances of being conscious during and after a crash, so you *can* unbuckle and get out, are *much* greater if you are belted.

Q: If my vehicle has airbags, why should I have to wear safety belts?

A: Airbags are supplemental systems only; so they work *with* safety belts - not instead of them. Whether or not an airbag is provided, all occupants still have to buckle up to get the most protection.

Also, in nearly all regions, the law requires wearing safety belts.

How to Wear Safety Belts Properly

This section is only for people of adult size.

There are special things to know about safety belts and children. And there are different rules for smaller children and infants. If a child will be riding in the vehicle, see *Older Children* ⇨ 74 or *Infants and Young Children* ⇨ 76. Follow those rules for everyone's protection.

It is very important for all occupants to buckle up. Statistics show that unbelted people are hurt more often in crashes than those who are wearing safety belts.

There are important things to know about wearing a safety belt properly.

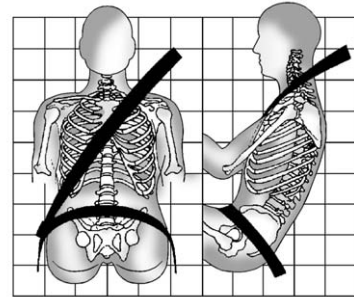

- Sit up straight and always keep your feet on the floor in front of you.
- Always use the correct buckle for your seating position.

- Wear the lap part of the belt low and snug on the hips, just touching the thighs. In a crash, this applies force to the strong pelvic bones and you would be less likely to slide under the lap belt. If you slid under it, the belt would apply force on your abdomen. This could cause serious or even fatal injuries.
- Wear the shoulder belt over the shoulder and across the chest. These parts of the body are best able to take belt restraining forces. The shoulder belt locks if there is a sudden stop or crash.

Warning

You can be seriously injured, or even killed, by not wearing your safety belt properly.

- Never allow the lap or shoulder belt to become loose or twisted.

(Continued)

Warning (Continued)

- Never wear the shoulder belt under both arms or behind your back.
- Never route the lap or shoulder belt over an armrest.
- Always wear the shoulder belt over the shoulder and across the chest. Use the safety belt guide, if needed, to position the shoulder belt over the shoulder and across the chest.

Lap-Shoulder Belt

All seating positions in the vehicle have a lap-shoulder belt.

The following instructions explain how to wear a lap-shoulder belt properly.

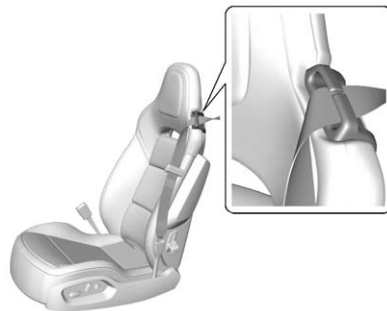

GT Seat Shown, Competition Sport Seat Similar

1. The seat has a safety belt guide. The safety belt guide helps position the shoulder belt over the shoulder and across the chest of smaller adults and older children who have outgrown booster seats. To use the safety belt guide, slide the edge of the belt webbing through the opening on the guide. Be sure the belt is not twisted. If a child will be riding in the vehicle, see *Older Children* ⇨ 74 or *Infants and Young Children* ⇨ 76.

- Adjust the seat, if the seat is adjustable, so you can sit up straight. To see how, see "Seats" in the Index.

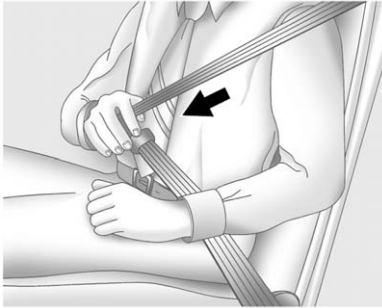

- Pick up the latch plate and pull the belt across you. Do not let it get twisted.
The lap-shoulder belt may lock if you pull the belt across you very quickly. If this happens, let the belt go back slightly to unlock it. Then pull the belt across you more slowly.
If the shoulder portion of a passenger belt is pulled out all the way, the child restraint

locking feature may be engaged. If this happens, let the belt go back all the way and start again.

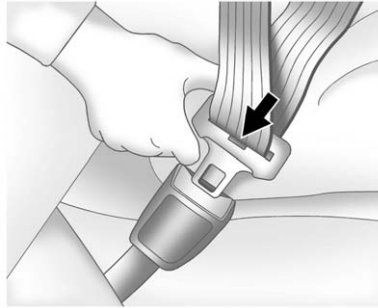

- Push the latch plate into the buckle until it clicks.
Pull up on the latch plate to make sure it is secure.
Position the release button on the buckle so that the safety belt could be quickly unbuckled if necessary.
- To make the lap part tight, pull up on the shoulder belt.

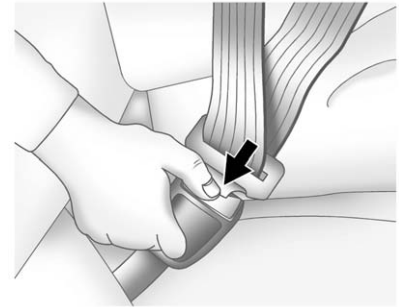

To unlatch the belt, push the button on the buckle. The belt should return to its stowed position.

Always stow the seat belt slowly. If the seat belt webbing returns quickly to the stowed position, the retractor may lock and cannot be pulled out. If this happens, pull the seat belt straight out firmly to unlock the webbing, and then release it. If the webbing is still locked in the retractor, see your retailer.

Before a door is closed, be sure the safety belt is out of the way. If a door is slammed against a safety belt, damage can occur to both the safety belt and the vehicle.

Safety Belt Pretensioners

This vehicle has safety belt pretensioners for the front outboard occupants. Although the safety belt pretensioners cannot be seen, they are part of the safety belt assembly. They can help tighten the safety belts during the early stages of a moderate to severe frontal, near frontal, or rear crash if the threshold conditions for pretensioner activation are met. Safety belt pretensioners can also help tighten the safety belts in a side crash or a roll-over event.

Pretensioners work only once. If the pretensioners activate in a crash, the pretensioners and probably other parts of the vehicle's safety belt system will need to be replaced. See *Replacing Safety Belt System Parts after a Crash* ⇨ 63.

Safety Belt Use During Pregnancy

Safety belts work for everyone, including pregnant women. Like all occupants, they are more likely to be seriously injured if they do not wear safety belts.



A pregnant woman should wear a lap-shoulder belt, and the lap portion should be worn as low as possible, below the rounding, throughout the pregnancy.

The best way to protect the foetus is to protect the mother. When a safety belt is worn properly, it is more likely

that the foetus will not be hurt in a crash. For pregnant women, as for anyone, the key to making safety belts effective is wearing them properly.

Safety System Check

Now and then, check that the safety belt reminder light, safety belts, buckles, latch plates, retractors, and anchorages are all working properly. Look for any other loose or damaged safety belt system parts that might keep a safety belt system from doing its job. See your dealer to have it repaired. Torn or frayed safety belts may not protect you in a crash. They can rip apart under impact forces. If a belt is torn or frayed, get a new one right away.

Make sure the safety belt reminder light is working. See *Safety Belt Reminders* ⇨ 101.

Keep safety belts clean and dry. See *Safety Belt Care* ⇨ 63.

Safety Belt Care

Keep belts clean and dry.

Warning

Do not bleach or dye safety belts. It may severely weaken them. In a crash, they might not be able to provide adequate protection. Clean safety belts only with mild soap and lukewarm water.

Replacing Safety Belt System Parts after a Crash

Warning

A crash can damage the safety belt system in the vehicle. A damaged safety belt system may not properly protect the person using it, resulting in serious injury or even death in a crash. To help make sure the safety belt systems are working

(Continued)

Warning (Continued)

properly after a crash, have them inspected and any necessary replacements made as soon as possible.

After a minor crash, replacement of safety belts may not be necessary. But the safety belt assemblies that were used during any crash may have been stressed or damaged. See your dealer to have the safety belt assemblies and safety belt guides inspected or replaced.

New parts and repairs may be necessary even if the safety belt system was not being used at the time of the crash.

Have the safety belt pretensioners checked if the vehicle has been in a crash, or if the airbag readiness light stays on after you start the vehicle or while you are driving. See *Airbag Readiness Light* ⇨ 102.

Warning

Safety procedures must always be observed when disposing of the vehicle or vehicle parts. Disposal should only be performed by an authorised service centre, to help protect the environment and your health.

Airbag System

The vehicle has the following airbags:

- A frontal airbag for the driver.
- A frontal airbag for the front outboard passenger.
- A seat-mounted side impact airbag for the driver.
- A seat-mounted side impact airbag for the front outboard passenger.

All vehicle airbags have the word AIRBAG on the trim or on a label near the deployment opening.

For frontal airbags, the word AIRBAG is on the centre of the steering wheel for the driver and on the instrument panel for the front outboard passenger.

For seat-mounted side impact airbags, the word AIRBAG is on the side of the seatback closest to the door.

Airbags are designed to supplement the protection provided by safety belts. Even though today's airbags

are also designed to help reduce the risk of injury from the force of an inflating bag, all airbags must inflate very quickly to do their job.

Here are the most important things to know about the airbag system:

Warning

You can be severely injured or killed in a crash if you are not wearing your safety belt, even with airbags. Airbags are designed to work with safety belts, not replace them. Also, airbags are not designed to inflate in every crash. In some crashes safety belts are the only restraint. See *When Should an Airbag Inflate?* ⇨ 66.

Wearing your safety belt during a crash helps reduce the chance of hitting things inside the vehicle or being ejected from it. Airbags are “supplemental restraints” to the safety belts. Everyone in the

(Continued)

Warning (Continued)

vehicle should wear a safety belt properly, whether or not there is an airbag for that person.

Warning

Because airbags inflate with great force and faster than the blink of an eye, anyone who is up against, or very close to, an airbag when it inflates can be seriously injured or killed. Do not sit unnecessarily close to any airbag, as you would be if sitting on the edge of the seat or leaning forward. Safety belts help keep you in position before and during a crash. Always wear the safety belt, even with airbags. The driver should sit as far back as possible while still maintaining control of the vehicle. The seat belts and the front outboard passenger airbags are most effective when

(Continued)

Warning (Continued)

you are sitting well back and upright in the seat with both feet on the floor.

Occupants should not lean on or sleep against the door or side windows in seating positions with seat-mounted airbags.

Warning

Children who are up against, or very close to, any airbag when it inflates can be seriously injured or killed. Always secure children properly in the vehicle. To read how, see *Older Children* ⇨ 74 or *Infants and Young Children* ⇨ 76.



There is an airbag readiness light on the instrument cluster which shows the airbag symbol.

The system checks the airbag electrical system for malfunctions. The light tells you if there is an electrical problem. See *Airbag Readiness Light* ⇨ 102.

Where Are the Airbags?



The driver frontal airbag is in the centre of the steering wheel.



The front outboard passenger frontal airbag is in the passenger side instrument panel.

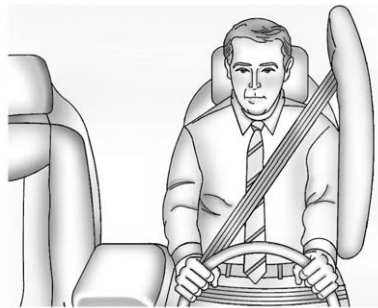

Driver Side Shown, Passenger Side Similar

The driver and front outboard passenger seat-mounted side impact airbags are in the sides of the seatbacks closest to the door.

⚠ Warning

If something is between an occupant and an airbag, the airbag might not inflate properly or it might force the object into that person causing severe injury or even death. The path of an inflating airbag must be kept

(Continued)

Warning (Continued)

clear. Do not put anything between an occupant and an airbag, and do not attach or put anything on the steering wheel hub or on or near any other airbag covering.

Do not use seat accessories that block the inflation path of a seat-mounted side impact airbag.

When Should an Airbag Inflate?

This vehicle is equipped with airbags. See *Airbag System* ⇨ 64. Airbags are designed to inflate if the impact exceeds the specific airbag system's deployment threshold. Deployment thresholds are used to predict how severe a crash is likely to be in time for the airbags to inflate and help restrain the occupants. The vehicle has electronic sensors that help the airbag system determine the

severity of the impact. Deployment thresholds can vary with specific vehicle design.

Frontal airbags are designed to inflate in moderate to severe frontal or near frontal crashes to help reduce the potential for severe injuries, mainly to the driver's or front outboard passenger's head and chest.

Whether the frontal airbags will or should inflate is not based primarily on how fast the vehicle is travelling. It depends on what is hit, the direction of the impact, and how quickly the vehicle slows down.

Frontal airbags may inflate at different crash speeds depending on whether the vehicle hits an object straight on or at an angle, and whether the object is fixed or moving, rigid or deformable, narrow or wide.

Frontal airbags are not intended to inflate during vehicle rollovers, in rear impacts, or in many side impacts.

In addition, the vehicle has advanced technology frontal airbags. Advanced technology frontal airbags adjust the restraint according to crash severity.

Seat-mounted side impact airbags are designed to inflate in moderate to severe side crashes depending on the location of the impact.

Seat-mounted side impact airbags are not designed to inflate in frontal impacts, near frontal impacts, rollovers, or rear impacts.

A seat-mounted side impact airbag is designed to inflate on the side of the vehicle that is struck.

In any particular crash, no one can say whether an airbag should have inflated simply because of the vehicle damage or repair costs.

What Makes an Airbag Inflate?

In a deployment event, the sensing system sends an electrical signal triggering a release of gas from the inflator. Gas from the inflator fills the airbag causing the bag to break out

of the cover. The inflator, the airbag, and related hardware are all part of the airbag module.

For airbag locations, see *Where Are the Airbags?* ⇨ 65.

How Does an Airbag Restrain?

In moderate to severe frontal or near frontal collisions, even belted occupants can contact the steering wheel or the instrument panel. In moderate to severe side collisions, even belted occupants can contact the inside of the vehicle.

Airbags supplement the protection provided by safety belts by distributing the force of the impact more evenly over the occupant's body.

But airbags would not help in many types of collisions, primarily because the occupant's motion is not toward those airbags. See *When Should an Airbag Inflate?* ⇨ 66.

Airbags should never be regarded as anything more than a supplement to safety belts.

What Will You See after an Airbag Inflates?

After the frontal and seat-mounted side impact airbags inflate, they quickly deflate, so quickly that some people may not even realise the airbags inflated. Some components of the airbag module may be hot for several minutes. For location of the airbag modules, see *What Makes an Airbag Inflate?* ⇨ 67.

The parts of the airbag that come into contact with you may be warm, but not too hot to touch. There may be some smoke and dust coming from the vents in the deflated airbags. Airbag inflation does not prevent the driver from seeing out of the windshield or being able to steer the vehicle, nor does it prevent people from leaving the vehicle.

Warning

When an airbag inflates, there may be dust in the air. This dust could cause breathing problems

(Continued)

Warning (Continued)

for people with a history of asthma or other breathing trouble. To avoid this, everyone in the vehicle should get out as soon as it is safe to do so. If you have breathing problems but cannot get out of the vehicle after an airbag inflates, then get fresh air by opening a window or a door. If you experience breathing problems following an airbag deployment, you should seek medical attention.

The vehicle has a feature that may automatically unlock the doors, turn the interior lamps on, turn on the hazard warning flashers and shut off the fuel system after the airbags inflate. The feature may also activate, without airbag inflation, after an event that exceeds a predetermined threshold. You can lock the doors, turn the interior lamps off and turn the hazard warning flashers off by using the controls for those features.

 **Warning**

A crash severe enough to inflate the airbags may have also damaged important functions in the vehicle, such as the fuel system, brake and steering systems, etc. Even if the vehicle appears to be drivable after a moderate crash, there may be concealed damage that could make it difficult to safely operate the vehicle.

Use caution if you should attempt to restart the engine after a crash has occurred.

In many crashes severe enough to inflate the airbag, windshields are broken by vehicle deformation. Additional windshield breakage may also occur from the front passenger airbag.

- Airbags are designed to inflate only once. After an airbag inflates, you will need some new parts for the airbag system. If you do not get them, the

airbag system will not be there to help protect you in another crash. A new system will include airbag modules and possibly other parts. The service manual for your vehicle covers the need to replace other parts.

- The vehicle has a crash sensing and diagnostic module which records information after a crash. See *Vehicle Data Recording and Privacy* ⇨ 296.
- Let only qualified technicians work on the airbag system. Improper service can mean that the airbag system will not work properly. See your dealer for service.

Passenger Sensing System

The vehicle has a passenger sensing system for the front outboard passenger position. The passenger airbag status indicator will light on the instrument panel when the vehicle is started.



The symbol for on and off will be visible during the system check. When the system check is complete, either the symbol for on or off will be visible. See *Passenger Airbag Status Indicator* ⇨ 102.

The passenger sensing system will turn off the front outboard passenger frontal airbag under certain conditions. No other airbag is affected by the passenger sensing system.

The passenger sensing system works with sensors that are part of the front outboard passenger seat and safety belt. The sensors are designed to detect the presence of a properly-seated occupant and determine if the front outboard passenger frontal airbag should be allowed to inflate or not.

According to accident statistics, children are safer when properly secured in a rear seat in the correct child restraint for their weight and size.

Rear-facing child restraints should not be transported in the vehicle, even if the airbag is off.

Never put a rear-facing child seat in the front. This is because the risk to the rear-facing child is so great, if the airbag inflates.

Warning

A child in a rear-facing child restraint can be seriously injured or killed if the passenger frontal airbag inflates. This is because the back of the rear-facing child restraint would be very close to the inflating airbag. A child in a forward-facing child restraint can be seriously injured or killed if the passenger frontal airbag inflates and the passenger seat is in a forward position.

(Continued)

Warning (Continued)

Even if the passenger sensing system has turned off the passenger frontal airbag, no system is fail-safe. No one can guarantee that an airbag will not inflate under some unusual circumstance, even though the airbag is off.

Secure rear-facing child restraints in a rear seat, even if the airbag is off. If you secure a forward-facing child restraint in the front outboard passenger seat, always move the seat as far back as it will go. It is better to secure the child restraint in a rear seat.

The passenger sensing system is designed to turn off the front outboard passenger frontal airbag if:

- The front outboard passenger seat is unoccupied.
- The system determines an infant is present in a child restraint.

- A front outboard passenger takes his/her weight off of the seat for a period of time.
- There is a critical problem with the airbag system or the passenger sensing system.

When the passenger sensing system has turned off the front outboard passenger frontal airbag, the off indicator will light and stay lit as a reminder that the airbag is off. See *Passenger Airbag Status Indicator* ⇨ 102.

The passenger sensing system is designed to turn on the front outboard passenger frontal airbag anytime the system senses that a person of adult size is sitting properly in the front outboard passenger seat.

When the passenger sensing system has allowed the airbag to be enabled, the on indicator will light and stay lit as a reminder that the airbag is active.

For some children, including children in child restraints, and for very small adults, the passenger sensing system may or may not turn off the front outboard passenger frontal airbag, depending upon the person's seating posture and body build. Everyone in the vehicle who has outgrown child restraints should wear a safety belt properly - whether or not there is an airbag for that person.

Warning

If the airbag readiness light ever comes on and stays on, it means that something may be wrong with the airbag system. To help avoid injury to yourself or others, have the vehicle serviced right away. See *Airbag Readiness Light* ⇨ 102 for more information, including important safety information.

If the On Indicator Is Lit for a Child Restraint

The passenger sensing system is designed to turn off the front outboard passenger airbag if the system determines that an infant is present in a child restraint. If a child restraint has been installed and the on indicator is lit:

1. Turn the vehicle off.
2. Remove the child restraint from the vehicle.
3. Remove any additional items from the seat such as blankets, cushions, seat covers, seat heaters, or seat massagers.
4. Reinstall the child restraint following the directions provided by the child restraint manufacturer and refer to *Securing Child Restraints* ⇨ 83.

Make sure the seat belt retractor is locked by pulling the shoulder belt all the way out of the retractor when installing the child restraint, even if the child restraint is equipped with a seat belt lock-off. When the retractor lock is set, the belt can be tightened but not pulled out of the retractor.

5. If, after reinstalling the child restraint and restarting the vehicle, the on indicator is still lit, turn the vehicle off. Then slightly recline the vehicle seatback and adjust the seat cushion, if adjustable, to make sure that the vehicle seatback is not pushing the child restraint into the seat cushion.
6. Restart the vehicle.

The passenger sensing system may or may not turn off the airbag for a child in a child restraint depending upon the child's size. It is better to secure the child restraint in a rear seat.

If the Off Indicator Is Lit for an Adult-Sized Occupant



If a person of adult size is sitting in the front outboard passenger seat, but the off indicator is lit, it could be because that person is not sitting properly in the seat or that the child restraint locking feature is engaged. Use the following steps to allow the system to detect that person and enable the front outboard passenger frontal airbag:

1. Turn the vehicle off.

2. Remove any additional material from the seat, such as blankets, cushions, seat covers, seat heaters, or seat massagers.
3. Place the seatback in the fully upright position.
4. Have the person sit upright in the seat, centred on the seat cushion, with legs comfortably extended.
5. If the shoulder portion of the belt is pulled out all the way, the child restraint locking feature will be engaged. This may unintentionally cause the passenger sensing system to turn the airbag off for some adult-sized occupants. If this happens, unbuckle the belt, let the belt go back all the way, and then buckle the belt again without pulling the belt out all the way.
6. Restart the vehicle and have the person remain in this position for two to three minutes after the on indicator is lit.

 **Warning**

If the front outboard passenger airbag is turned off for an adult-sized occupant, the airbag will not be able to inflate and help protect that person in a crash, resulting in an increased risk of serious injury or even death. An adult-sized occupant should not ride in the front outboard passenger seat, if the passenger airbag off indicator is lit.

Additional Factors Affecting System Operation

Safety belts help keep the passenger in position on the seat during vehicle manoeuvres and braking, which helps the passenger sensing system maintain the passenger airbag status. See “Safety Belts” and “Child Restraints” in the Index for additional information about the importance of proper restraint use.

A thick layer of additional material, such as a blanket or cushion, or aftermarket equipment such as seat covers, seat heaters, and seat massagers can affect how well the passenger sensing system operates. We recommend that you not use seat covers or other aftermarket equipment except when approved by GM for your specific vehicle. See *Adding Equipment to the Airbag-Equipped Vehicle* ⇨ 73 for more information about modifications that can affect how the system operates.

The on indicator may be lit if an object, such as a briefcase, handbag, grocery bag, laptop, or other electronic device, is put on an unoccupied seat. If this is not desired, remove the object from the seat.

 **Warning**

Stowing of articles under the passenger seat or between the passenger seat cushion and

(Continued)

Warning (Continued)

seatback may interfere with the proper operation of the passenger sensing system.

Servicing the Airbag-Equipped Vehicle

Airbags affect how the vehicle should be serviced. There are parts of the airbag system in several places around the vehicle. Your dealer and the service manual have information about servicing the vehicle and the airbag system.

 **Warning**

For up to 10 seconds after the vehicle is turned off and the battery is disconnected, an airbag can still inflate during improper service. You can be injured if you are close to an airbag when it inflates. Avoid yellow connectors. They are probably part of the

(Continued)

Warning (Continued)

airbag system. Be sure to follow proper service procedures, and make sure the person performing work for you is qualified to do so.

 **Warning**

Safety procedures must always be observed when disposing of the vehicle or vehicle parts. Disposal should only be performed by an authorised service centre, to help protect the environment and your health.

Adding Equipment to the Airbag-Equipped Vehicle

Adding accessories that change the vehicle's frame, bumper system, height, front end or side sheet metal, may keep the airbag system from working properly. The operation of the airbag system can also be affected by changing or moving any parts of the front seats,

safety belts, the airbag sensing and diagnostic module, steering wheel, instrument panel, front sensors, or airbag wiring.

Your dealer and the service manual have information about the location of the airbag sensors, sensing and diagnostic module, and airbag wiring.

In addition, the vehicle has a passenger sensing system for the front outboard passenger position, which includes sensors that are part of the passenger seat. The passenger sensing system may not operate properly if the original seat trim is replaced with non-GM covers, upholstery or trim, or with GM covers, upholstery or trim designed for a different vehicle. Any object, such as an aftermarket seat heater or a comfort enhancing pad or device, installed under or on top of the seat fabric, could also interfere with the operation of the passenger sensing system. This could either prevent proper deployment of the passenger airbag(s) or prevent the passenger sensing system from properly

turning off the passenger airbag(s). See *Passenger Sensing System* ⇨ 68.

If you have to modify your vehicle because you have a disability and have questions about whether the modifications will affect the vehicle's airbag system, or if you have questions about whether the airbag system will be affected if the vehicle is modified for any other reason, see your dealer.

Airbag System Check

The airbag system does not need regularly scheduled maintenance or replacement. Make sure the airbag readiness light is working. See *Airbag Readiness Light* ⇨ 102.

Caution

If an airbag covering is damaged, opened, or broken, the airbag may not work properly. Do not open or break the airbag coverings. If there are any

(Continued)

Caution (Continued)

opened or broken airbag coverings, have the airbag covering and/or airbag module replaced. For the location of the airbags, see *Where Are the Airbags?* ⇨ 65. See your dealer for service.

Replacing Airbag System Parts after a Crash**⚠ Warning**

A crash can damage the airbag systems in the vehicle. A damaged airbag system may not work properly and may not protect you and your passenger(s) in a crash, resulting in serious injury or even death. To help make sure the airbag systems are working properly after a crash, have them

(Continued)

Warning (Continued)

inspected and any necessary replacements made as soon as possible.

If an airbag inflates, you will need to replace airbag system parts. See your dealer for service.

If the airbag readiness light stays on after the vehicle is started or comes on when you are driving, the airbag system may not work properly. Have the vehicle serviced right away. See *Airbag Readiness Light* ⇨ 102 for more information.

⚠ Warning

Safety procedures must always be observed when disposing of the vehicle or vehicle parts. Disposal should only be performed by an authorised service centre, to help protect the environment and your health.

Child Restraints**Older Children**

Older children who have outgrown booster seats should wear the vehicle safety belts.

The manufacturer instructions that come with the booster seat state the weight and height limitations for that booster. Use a booster seat with a lap-shoulder belt until the child passes the fit test below:

- Sit all the way back on the seat. Do the knees bend at the seat edge? If yes, continue. If no, return to the booster seat.
- Fasten the lap-shoulder belt. Does the shoulder belt rest on the shoulder? If yes, continue. If no, return to the booster seat.
- Does the lap belt fit low and snug on the hips, touching the thighs? If yes, continue. If no, return to the booster seat.
- Can proper safety belt fit be maintained for the length of the trip? If yes, continue. If no, return to the booster seat.

Q: What is the proper way to wear safety belts?

A: An older child should wear a lap-shoulder belt and get the additional restraint a shoulder belt can provide. The shoulder

belt should not cross the face or neck. The lap belt should fit snugly below the hips, just touching the top of the thighs. This applies belt force to the child's pelvic bones in a crash. It should never be worn over the abdomen, which could cause severe or even fatal internal injuries in a crash.

According to accident statistics, children are safer when properly restrained in a rear seating position.

In a crash, children who are not buckled up can strike other people who are buckled up, or can be thrown out of the vehicle. Older children need to use safety belts properly.

Warning

Never allow more than one child to wear the same safety belt. The safety belt cannot properly spread the impact forces. In a crash, they can be crushed together and

(Continued)

Warning (Continued)

seriously injured. A safety belt must be used by only one person at a time.

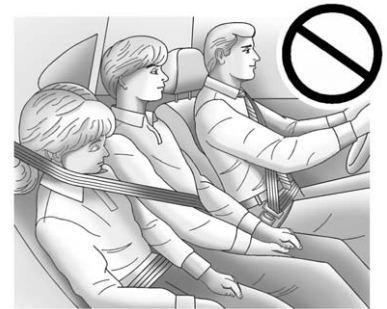

Warning

Never allow a child to wear the safety belt with the shoulder belt behind their back. A child can be seriously injured by not wearing the lap-shoulder belt properly. In a crash, the child would not be

(Continued)

Warning (Continued)

restrained by the shoulder belt. The child could move too far forward increasing the chance of head and neck injury. The child might also slide under the lap belt. The belt force would then be applied right on the abdomen. That could cause serious or fatal injuries. The shoulder belt should go over the shoulder and across the chest.

**Infants and Young Children**

Everyone in a vehicle needs protection! This includes infants and all other children. Neither the distance travelled nor the age and size of the traveller changes the need, for everyone, to use safety restraints.

⚠ Warning

Children can be seriously injured or strangled if a shoulder belt is wrapped around their neck. The shoulder belt can tighten but cannot be loosened if it is locked. The shoulder belt locks when it is pulled all the way out of the retractor. It unlocks when the shoulder belt is allowed to go all the way back into the retractor, but it cannot do this if it is wrapped around a child's neck. If the shoulder belt is locked and

(Continued)

Warning (Continued)

tightened around a child's neck, the only way to loosen the belt is to cut it.

Never leave children unattended in a vehicle and never allow children to play with the safety belts.

Every time infants and young children ride in vehicles, they should have the protection provided by appropriate child restraints. Neither the vehicle's safety belt system nor its airbag system is designed for them.

Children who are not restrained properly can strike other people, or can be thrown out of the vehicle.

⚠ Warning

Never hold an infant or a child while riding in a vehicle. Due to crash forces, an infant or a child

(Continued)

Warning (Continued)

will become so heavy it is not possible to hold it during a crash. For example, in a crash at only 40 km/h (25 mph), a 5.5 kg (12 lb) infant will suddenly become a 110 kg (240 lb) force on a person's arms. An infant should be secured in an appropriate restraint.

**Warning**

Children who are up against, or very close to, any airbag when it inflates can be seriously injured or killed. Never put a rear-facing child restraint in the front outboard seat. Secure a rear-facing child restraint in a rear seat. It is also better to secure a forward-facing child restraint in a rear seat. If you must secure a forward-facing child restraint in the front outboard seat, always move the front passenger seat as far back as it will go.



Selection of a particular restraint should take into consideration not only the child's weight, height, and age but also whether or not the restraint will be compatible with the motor vehicle in which it will be used.

For most basic types of child restraints, there are many different models available. When purchasing a child restraint, be sure it is designed to be used in a motor vehicle.

The restraint manufacturer's instructions that come with the restraint state the weight and height limitations for a particular child restraint.

Warning

To reduce the risk of neck and head injury in a crash, infants and toddlers should be secured in a rear-facing child restraint until age two, or until they reach the maximum height and weight limits of their child restraint.

Warning

A young child's hip bones are still so small that the vehicle's regular safety belt may not remain low on the hip bones, as it should. Instead, it may settle up around the child's abdomen. In a crash, the belt would apply force on a body area that is unprotected by any bony structure. This alone

(Continued)

Warning (Continued)

could cause serious or fatal injuries. To reduce the risk of serious or fatal injuries during a crash, young children should always be secured in appropriate child restraints.

Child Restraint Systems



Rear-Facing Infant Seat

A rear-facing infant seat provides restraint with the seating surface against the back of the infant.

The harness system holds the infant in place and, in a crash, acts to keep the infant positioned in the restraint.



Forward-Facing Child Seat

A forward-facing child seat provides restraint for the child's body with the harness.

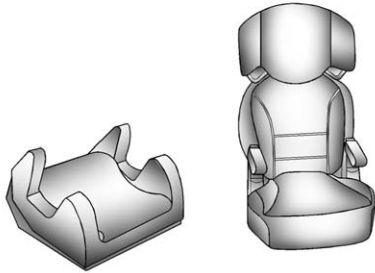

Booster Seats

A booster seat is a child restraint designed to improve the fit of the vehicle's safety belt system. A booster seat can also help a child to see out the window.

Securing an Add-On Child Restraint in the Vehicle

Warning

A child can be seriously injured or killed in a crash if the child restraint is not properly secured in the vehicle. Secure the child

(Continued)

Warning (Continued)

restraint properly in the vehicle using the vehicle's safety belt, following the instructions that came with that child restraint and the instructions in this manual.

To help reduce the chance of injury, the child restraint must be secured in the vehicle. Child restraint systems must be secured in vehicle seats by lap belts or the lap belt portion of a three-point belt. Children can be endangered in a crash if the child restraint is not properly secured in the vehicle.

When securing an add-on child restraint, refer to the instructions that come with the restraint which may be on the restraint itself or in a booklet, or both, and to this manual. The child restraint instructions are important, so if they are not available, obtain a replacement copy from the manufacturer.

Keep in mind that an unsecured child restraint can move around in a collision or sudden stop and injure people in the vehicle. Be sure to properly secure any child restraint in the vehicle - even when no child is in it.

Securing the Child within the Child Restraint

Warning

A child can be seriously injured or killed in a crash if the child is not properly secured in the child restraint. Secure the child properly following the instructions that came with that child restraint.

Where to Put the Restraint

According to accident statistics, children and infants are safer when properly restrained in a child restraint system or infant restraint system secured in a rear seating position.

Whenever possible, children age 12 and under should be secured in a rear seating position.

Warning

Do not use a rearward facing child restraint on a seat protected by an airbag in front of it!

Danger

When using a child restraint system on the front passenger seat, the airbag systems for the front passenger seat must be deactivated; if not, the triggering of the airbags poses a risk of fatal injury to the child.

This is especially the case if rear-facing child restraint systems are used on the front passenger seat.



DO NOT place rear-facing child seat on this seat. DEATH OR SERIOUS INJURY can occur. This is because the risk to the rear-facing child is so great, if the airbag deploys.

When securing a child restraint in the front passenger position, study the instructions that came with your child restraint to make sure it is compatible with this vehicle.

Child restraints and booster seats vary considerably in size, and some may fit in certain seating positions better than others.

Depending on where you place the child restraint and the size of the child restraint, you may not be able to access adjacent safety belt assemblies or ISOFIX anchors for additional passengers or child restraints. Adjacent seating positions should not be used if the child restraint prevents access to or interferes with the routing of the safety belt.

Wherever a child restraint is installed, be sure to secure the child restraint properly.

Keep in mind that an unsecured child restraint can move around in a collision or sudden stop and injure people in the vehicle. Be sure to properly secure any child restraint in your vehicle - even when no child is in it.

ISOFIX Child Restraint Systems Installation Suitability

Mass Group	Class Size	Fixture	Vehicle ISOFIX Positions Passenger
Carrycot	F	ISO/L1	X
	G	ISO/L2	X
0 (up to 10 kg)	E	ISO/R1	X
0+ (up to 13 kg)	E	ISO/R1	X
	D	ISO/R2	X
	C	ISO/R3	X
I (9 to 18 kg)	D	ISO/R2	X
	C	ISO/R3	X
	B	ISO/F2	X
	B1	ISO/F2X	X
	A	ISO/F3	X

X = ISOFIX position not suitable for ISOFIX child restraint systems in this mass group and/or this size class.

IUF = Suitable for ISOFIX forward child restraint systems of universal category approved for use in the mass group.

IL = Suitable for particular ISOFIX child restraint systems of the “specific vehicle,” “restricted,” or “semi-universal” categories.

Child Restraint Systems Installation Suitability

Mass Group		Seating Positions Passenger
Group 0	Up to 10 kg	X
Group 0 +	Up to 13 kg	X
Group I	9 to 18 kg	X
Group II	15 to 25 kg	X
Group III	22 to 36 kg	X
X = Seat position not suitable for children in this mass group.		
U = Suitable for “universal” category restraints approved for use in this mass group.		
UF = Suitable for forward-facing “universal” category restraints approved for use in this mass group.		
L = Suitable for particular child restraints of the “specific vehicle,” “restricted,” or “semi-universal” categories.		
B = Built-in restraint approved for this mass group.		

ISOFIX Size Class and Seat Device:

A - ISO/F3 : Forward-facing child restraint system for children of maximum size in the weight class 9 to 18 kg.

B - ISO/F2 : Forward-facing child restraint system for smaller children in the weight class 9 to 18 kg.

B1 - ISO/F2X : Forward-facing child restraint system for smaller children in the weight class 9 to 18 kg.

C - ISO/R3 : Rear-facing child restraint system for children of maximum size in the weight class up to 13 kg.

D - ISO/R2 : Rear-facing child restraint system for smaller children in the weight class up to 13 kg.

E - ISO/R1 : Rear-facing child restraint system for young children in the weight class up to 13 kg.

ISOFIX Child Restraint Systems

Some child restraints have an ISOFIX system. As part of the ISOFIX system, your child restraint may have lower attachments and/or a top tether. The ISOFIX system can help hold the child restraint in place during driving or in a crash. Some vehicles have lower and/or top tether anchors designed to secure a child restraint with lower attachments and/or a top tether.

Some child restraints with a top tether are designed to be used whether the top tether is anchored or not. Other child restraints require that the top tether be anchored. A national or local law may require that the top tether be anchored.

Your vehicle does not have lower anchors or top tether anchors to secure a child restraint with the ISOFIX system. If a national or local law requires that your top tether be anchored, do not use a child restraint in this vehicle because a top tether cannot be properly anchored. You must use the safety

belts to secure your child restraint in this vehicle, unless a national or local law requires that the top tether be anchored. Refer to the child restraint instructions and instructions in this manual for securing a child restraint using the vehicle's safety belts. See *Securing Child Restraints* ⇨ 83.

Securing Child Restraints

This vehicle has airbags. In addition, the vehicle has a passenger sensing system which is designed to turn off the front outboard passenger frontal airbag under certain conditions. See *Passenger Sensing System* ⇨ 68 and *Passenger Airbag Status Indicator* ⇨ 102 for more information, including important safety information.



DO NOT place rear-facing child seat on this seat. DEATH OR SERIOUS INJURY can occur. This is because the risk to the rear-facing child is so great, if the airbag deploys.

Warning

A child in a rear-facing child restraint can be seriously injured or killed if the front outboard passenger frontal airbag inflates. This is because the back of the rear-facing child restraint would be very close to the inflating airbag. A child in a forward-facing child restraint can be seriously injured or killed if the front

(Continued)

Warning (Continued)

outboard passenger frontal airbag inflates and the passenger seat is in a forward position.

Even if the passenger sensing system has turned off the front outboard passenger frontal airbag, no system is fail-safe. No one can guarantee that an airbag will not deploy under some unusual circumstance, even though it is turned off.

Secure rear-facing child restraints in a rear seat, even if the airbag is off. If you secure a forward-facing child restraint in the front seat, always move the front passenger seat as far back as it will go. It is better to secure the child restraint in a rear seat.

See *Passenger Sensing System* ⇨ 68 for additional information.

Rear-facing child restraints should not be installed in the vehicle, even if the airbag is off.

Do not secure a child seat in a position without a top tether anchor if a national or local law requires that the top tether be anchored, or if the instructions that come with the child restraint say that the top strap must be anchored.

When using the lap-shoulder belt to secure the child restraint in this position, follow the instructions that came with the child restraint and the following instructions:

1. Move the seat as far back as it will go before securing the forward-facing child restraint.

When the passenger sensing system has turned off the front outboard passenger frontal airbag, the off indicator on the passenger airbag status indicator should light and stay lit when you start the vehicle. See *Passenger Airbag Status Indicator* ⇨ 102.

2. Put the child restraint on the seat.

Remove the safety belt from the guide by sliding the webbing through the opening on the guide. Do not secure the child restraint with the safety belt routed through the guide.

3. Pick up the latch plate, and run the lap and shoulder portions of the vehicle's safety belt through or around the restraint. The child restraint instructions will show you how.

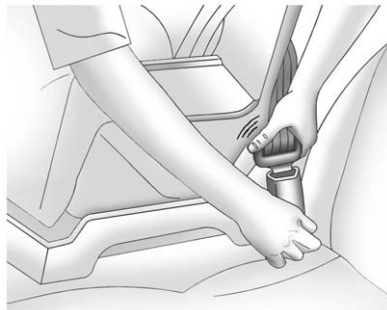

4. Push the latch plate into the buckle until it clicks.

Position the release button on the buckle so that the safety belt could be quickly unbuckled if necessary.



5. Pull the shoulder belt all the way out of the retractor to set the lock. When the retractor lock is set, the belt can be tightened but not pulled out of the retractor.

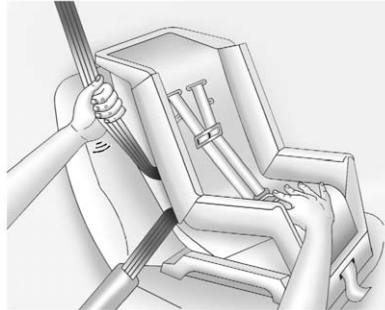

6. To tighten the belt, push down on the child restraint, pull the shoulder portion of the belt to tighten the lap portion of the belt, and feed the shoulder belt back into the retractor. When installing a forward-facing child restraint, it may be helpful to use your knee to push down on the child restraint as you tighten the belt.

Try to pull the belt out of the retractor to make sure the retractor is locked. If the retractor is not locked, repeat Steps 5 and 6.

7. Before placing a child in the child restraint, make sure it is securely held in place. To check, grasp the child restraint at the safety belt path and attempt to move it side to side and back and forth. When the child restraint is properly installed, there should be no more than 2.5 cm (1 in) of movement.

If the airbag is off, the off indicator in the passenger airbag status indicator will come on and stay on when the vehicle is started.

If a child restraint has been installed and the on indicator is lit, see "If the On Indicator Is Lit for a Child Restraint" under *Passenger Sensing System* ⇨ 68 for more information.

To remove the child restraint, unfasten the vehicle safety belt and let it return to the stowed position.

Return the seat belt into the guide by sliding the webbing through the opening on the guide.

Storage

Storage Compartments

Storage Compartments	86
Instrument Panel Storage	86
Glove Box	86
Cupholders	87
Rear Storage	87
Centre Console Storage	88

Additional Storage Features

Cargo Cover	88
Cargo Net	89
Convenience Net	89

Storage Compartments

Warning

Do not store heavy or sharp objects in storage compartments. In a crash, these objects may cause the cover to open and could result in injury.

Instrument Panel Storage

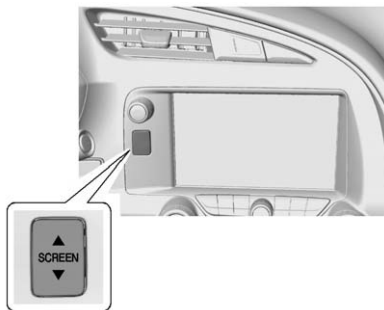

Press the button to lower the display and access the storage behind it.

There is a USB port in the upper left hand corner. See “Audio Players” in the infotainment manual.

Press the button again to raise the display and close the storage area.

The storage area cannot be operated when Valet Mode, if equipped, is enabled. See *Vehicle Personalisation* ⇨ 127.

Keep the storage area closed when not in use.

Glove Box

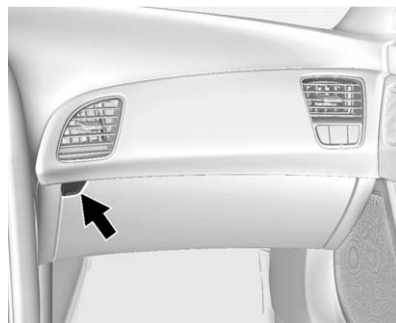

To open, press the button.
If equipped, the glove box locks when Valet Mode is enabled. See *Vehicle Personalisation* ⇨ 127.

Cupholders

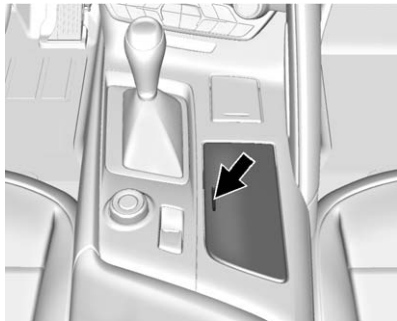

Press the top of the cover to access the cupholders. There is a removable divider.

Rear Storage

Caution

Do not store heavy or sharp objects in the rear storage compartments located in the hatch/boot area. The objects could damage the underside of the hatch/boot.

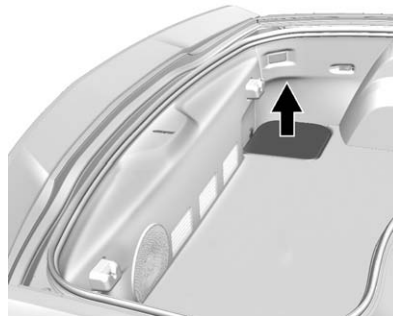

Coupe Shown, Convertible Similar

There is storage on the driver side in the floor of the hatch/boot area. Pull up to open the cover.

Rear Boot Partition

If equipped with a convertible top, there is a boot partition to keep cargo from getting in the way of the convertible top. The boot partition must be in place for the convertible top to move. If the boot partition is not properly in place, a message will display and a noise will be heard. See *Convertible Top Messages* ⇨ 117.

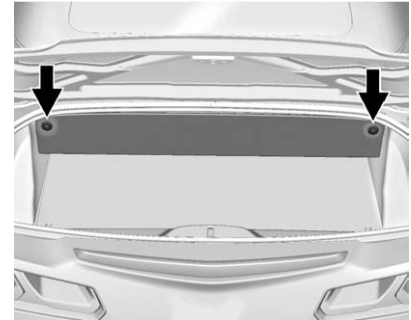

Convertible Only

Pull the divider up and snap it into place on both sides of the boot.

The boot partition is a flat carpeted board with a horizontal flap that can be attached to the top of the boot to provide additional storage space.



With the convertible top up, the boot partition can be unsnapped and laid flat to increase boot cargo space.

Centre Console Storage

Caution

The area inside the console can get hot. Do not store items that can be damaged by heat.

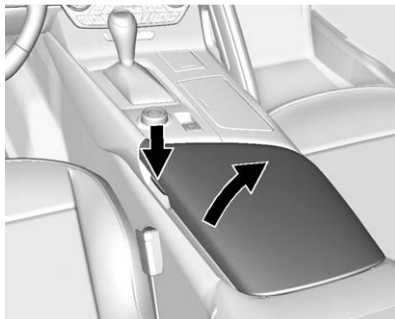

To open, press the button on the driver side.

There are two USB ports and an accessory outlet inside. See *Power Outlets* ⇨ 93 and “Audio Players” in the infotainment manual.

Additional Storage Features

Cargo Cover

If equipped, the cargo cover provides hidden storage in the rear area of the vehicle. The cover also blocks glare from the removable roof panel when it is stored in the rear compartment.

The cargo cover has two pieces: a flat and an L-shaped piece.

Attaching the Flat Cargo Cover

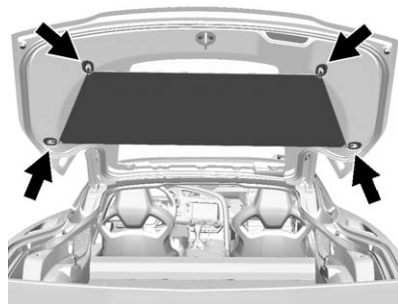

Attach the elastic loops on the four corners of the cargo cover to the hooks on the front and rear corners of the hatch.

Attaching the L-Shaped Cargo Cover

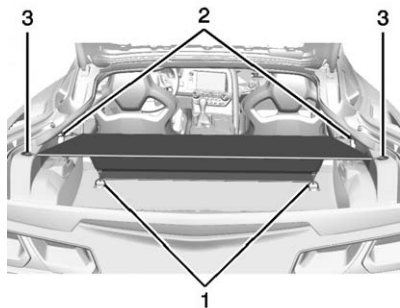

1. Attach the plastic loops on the cover to the tie-downs on the floor (1) and to the side panels (2).
2. Attach the rear loops on the cover to the hooks on the side panels (3).

Do not use the cargo cover hooks and tie-downs to secure anything but the cargo cover. They are not designed for heavy loads.

Cargo Net

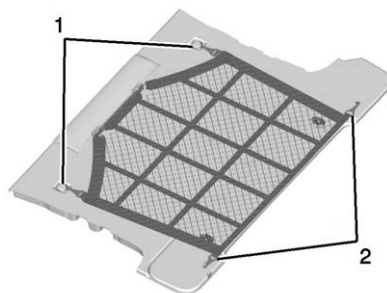

The vehicle comes with a barrier net. Unfold the net and fasten the front hooks (1) as shown to the front tie-downs in the cargo area. Pull the net over any items loaded onto the floor and fasten the rear hooks (2) to the rear tie-downs.

Convenience Net



The vehicle may have a convenience net to be used for small loads. Attach the net to the hooks on the rear of the storage area. The net should not be used to store heavy loads.

Instruments and Controls

Controls

Steering Wheel Adjustment	91
Steering Wheel Controls	91
Horn	91
Windscreen Wiper/Washer	91
Headlamp Washer	92
Clock	93
Power Sockets	93

Warning Lights, Gauges, and Indicators

Warning Lights, Gauges, and Indicators	94
Instrument Cluster	95
Speedometer	100
Mileometer	100
Trip Odometer	100
Rev Counter	100
Fuel Gauge	100
Engine Coolant Temperature Gauge	101
Seat Belt Reminders	101
Airbag Readiness Light	102
Passenger Airbag Status Indicator	102
Charging System Light	103

Malfunction Indicator Lamp (Check Engine Light)	104
Brake System Warning Light	105
Electric Parking Brake Light	106
Service Electric Parking Brake Light	106
Antilock Brake System (ABS) Warning Light	107
Gear Shifting Light	107
Traction Off Light	107
Traction Control System (TCS)/Electronic Stability Control Light	108
Electronic Stability Control (ESC) Off Light	108
Engine Coolant Temperature Warning Light	108
Tyre Pressure Light	109
Engine Oil Pressure Light	109
Low Fuel Warning Light	110
Security Light	110
Main-Beam On Light	110
Rear Fog Lamp Light	110
Lamps On Reminder	110
Cruise Control Light	111
Door Ajar Light	111

Information Displays

Driver Information Centre (DIC)	111
Head-Up Display (HUD)	113

Vehicle Messages

Vehicle Messages	116
Battery Voltage and Charging Messages	117
Brake System Messages	117
Compass Messages	117
Convertible Top Messages	117
Cruise Control Messages	119
Door Ajar Messages	119
Engine Cooling System Messages	119
Engine Oil Messages	120
Engine Power Messages	120
Fuel System Messages	120
Key and Lock Messages	120
Lamp Messages	121
Ride Control System Messages	121
Airbag System Messages	124
Security Messages	124
Service Vehicle Messages	124
Starting the Vehicle Messages	124
Tyre Messages	125
Transmission Messages	125

Vehicle Reminder Messages	126
Vehicle Speed Messages	126
Washer Fluid Messages	126
Window Messages	126

Vehicle Personalisation

Vehicle Personalisation	127
-------------------------------	-----

Controls

Steering Wheel Adjustment

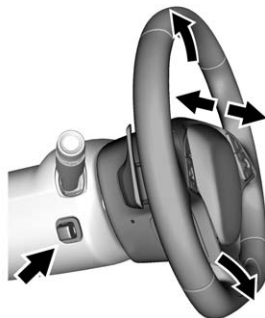

Press the control to move the tilt and telescoping steering wheel up and down or forward and rearward.

Both the tilt and telescoping steering column positions can be stored with your memory settings. See *Memory Seats* ⇨ 54.

Do not adjust the steering wheel while driving.

Steering Wheel Controls

The infotainment system can be operated by using the steering wheel controls. See "Steering Wheel Controls" in the infotainment manual.

Horn

Press near or on the horn symbols on the steering wheel pad to sound the horn.

Windscreen Wiper/Washer



The windscreen wiper/washer lever is on the right side of the steering column.

With the ignition in ACC/ACCESSORY or ON/RUN/START, move the windscreen wiper stalk to select the wiper speed.

HI : Use for fast wipes.

LO : Use for slow wipes.



INT (Intermittent Wipes) : Move the lever up to INT for intermittent wipes, then turn the  INT band up for more frequent wipes or down for less frequent wipes.

OFF : Use to turn the wipers off.

1X (Mist) : For a single wipe, briefly move the wiper lever down. For several wipes, hold the wiper lever down.

Warning

In freezing weather, do not use the washer until the windshield is warmed. Otherwise the washer fluid can form ice on the windshield, blocking your vision.

 **(Windscreen Washer)** : Pull the windshield wiper lever toward you to spray washer fluid and activate the wipers. The wipers will continue until the lever is released or the maximum wash time is reached. When the stalk is released, additional wipes may occur depending on how long the windshield washer had been activated. See *Washer Fluid* ⇨ 225 for information on filling the windshield washer fluid reservoir.

Clear snow and ice from the wiper blades and windshield before using them. If frozen to the windshield, carefully loosen or thaw them. Damaged blades should be replaced. See *Wiper Blade Replacement* ⇨ 235.

Heavy snow or ice can overload the wiper motor.

Wiper Parking

If the ignition is put in OFF while the wipers are on LO, HI, or INT, they will immediately stop.

If the windshield wiper lever is then moved to OFF before the driver door is opened or within 10 minutes, the wipers will restart and move to the base of the windshield.

If the ignition is put in OFF while the wipers are performing wipes due to windshield washing, the wipers continue to run until they reach the base of the windshield.

Headlamp Washer

The headlamp washers are on the front fascia forward of the headlamps.

The headlamps must be on in order to use the headlamp washers. If the headlamps are not on, only the windshield will be washed.

Pull the wiper lever toward you and hold briefly to activate. The headlamp washers will spray once, pause, and spray again. The headlamp washer will spray again after five windshield wash cycles.

To refill the windshield washer fluid, see *Washer Fluid* ⇨ 225.

Clock

The infotainment system controls are used to access the time and date settings through the menu system. See “Home Page” in the infotainment manual for information about how to use the menu system.

Setting the Time

To set the time:

1. From the Home Page, press the SETTINGS screen button and press Time and Date.
2. Press Set Time and press + or – to increase or decrease hours, minutes, and AM or PM. Press 12Hr or 24Hr for 12 or 24 hour clock.
3. Press ◀ to go back to the previous menu.

If auto timing is set, the time displayed on the clock may not update immediately when driving into a new time zone.

To set the date:

1. Press the SETTINGS screen button and press Time and Date.
2. Press Set Date and press + or – to increase or decrease month, day, or year.
3. Press ◀ to go back to the previous menu.

To set the clock display:

1. Press the SETTINGS screen button and press Time and Date.
2. Press Clock Display and press OFF or ON to turn the clock display off or on.
3. Press ◀ to go back to the previous menu.

Power Sockets

Use the accessory power outlet to plug in electrical equipment, such as a mobile phone or MP3 player.

There are three accessory power outlets:

- In front of the cupholder. Open the door compartment to access.
- Inside the centre console storage compartment.
- In the rear compartment.

Lift the cover to access and replace when not in use.

The power outlets in front of the cupholder and inside the centre console storage compartment are powered when the ignition is in ON/RUN/START or ACC/ACCESSORY, or until the driver door is opened within 10 minutes of turning off the vehicle. See *Retained Accessory Power (RAP)* ⇨ 171.

The rear compartment power outlet is powered at all times. The vehicle's battery may run down if the power outlet is used while the ignition is in Stopping the Engine/OFF. Use this power outlet for plugging in the battery maintainer, if equipped.

 **Warning**

Power is always supplied to the boot outlet. Do not leave electrical equipment plugged in when the vehicle is not in use because the vehicle could catch fire and cause injury or death.

Caution

Leaving electrical equipment plugged in for an extended period of time while the vehicle is off will drain the battery. Always unplug electrical equipment when not in use and do not plug in equipment that exceeds the maximum 20 amp rating.

Certain electrical accessories may not be compatible with the accessory power outlet and could overload vehicle or adapter fuses. If a problem is experienced, see your dealer.

When adding electrical equipment, ensure that you follow the proper installation instructions included with the equipment. See *Add-On Electrical Equipment* ⇨ 201.

It is recommended that a qualified technician or dealer be seen for the proper installation of your equipment.

Caution

Hanging heavy equipment from the power outlet can cause damage not covered by the vehicle warranty. The power outlets are designed for accessory power plugs only, such as mobile phone charge cords.

Warning Lights, Gauges, and Indicators

Warning lights and gauges can signal that something is wrong before it becomes serious enough to cause an expensive repair or replacement. Paying attention to the warning lights and gauges could prevent injury.

Some warning lights come on briefly when the engine is started to indicate they are working. When one of the warning lights comes on and stays on while driving, or when one of the gauges shows there may be a problem, check the section that explains what to do. Waiting to do repairs can be costly and even dangerous.

Instrument Cluster



Sport Theme Shown, Other Themes Similar

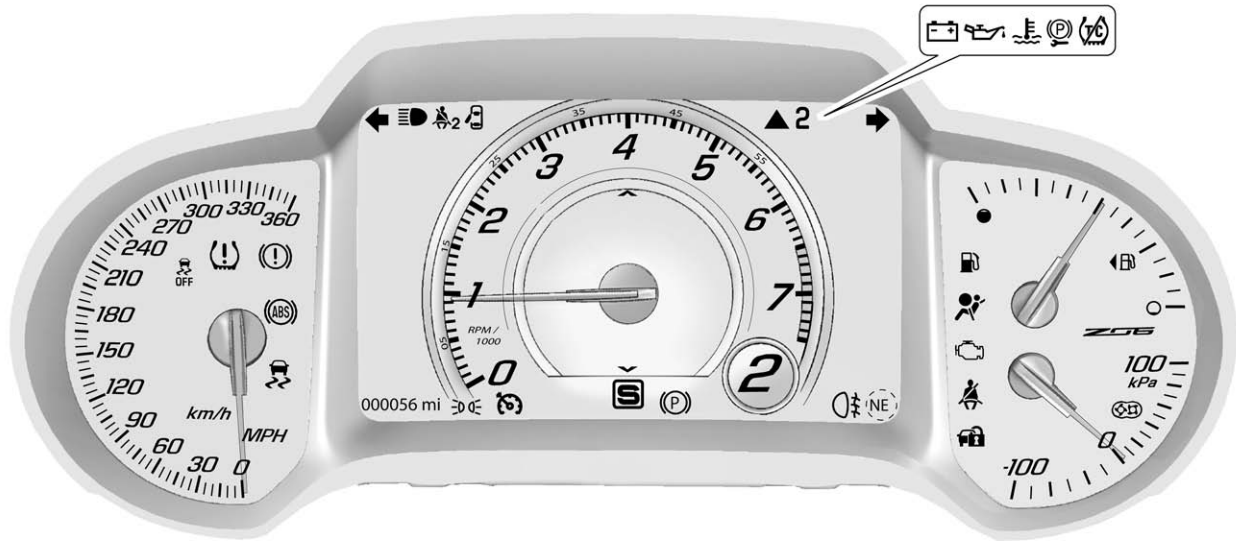

Z06 Sport Theme Shown, Other Themes Similar

Reconfigurable Instrument Cluster

There are four instrument cluster display configurations to choose from: Link to Drive Mode, Sport, Track, and Tour. The style of the centre of the instrument cluster will change depending on the theme selected. If Link to Drive Mode is chosen, the cluster configuration will change to match the setting on the driver mode control on the console. See *Driver Mode Control* ⇨ 187. If Weather or Eco are selected with the driver mode control, the cluster will display the Tour theme.

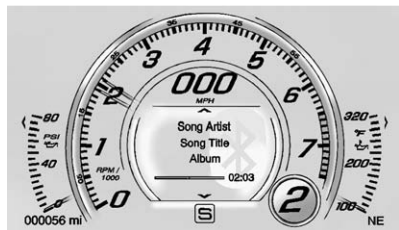

Sport

Includes a circular tachometer centred in the display. The DIC is contained within the tachometer

ring. Additionally, there are two configurable pocket gauges in the lower left and right corners.

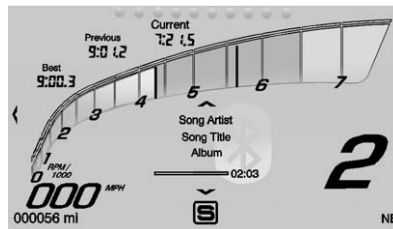

Track

Includes an asymmetric tachometer with prominent red-line markings and a lap timer that shows the current, previous, and best lap.

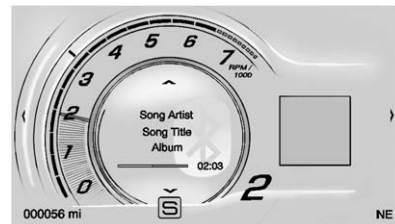

Tour

Includes a partial tachometer ring. The DIC is contained within the tachometer ring. There is also an area used to display icons or images for the DIC or phone contacts.

The instrument cluster display configuration is selected through the cluster menu. See “Settings” under “Cluster Menu” following.

Cluster Menu

There is an interactive display area in the centre of the instrument cluster.

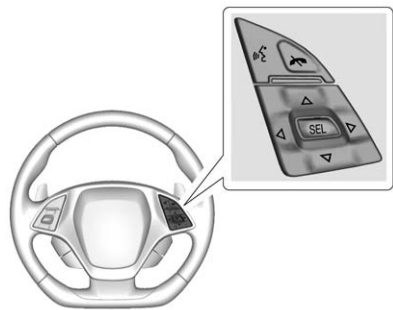

Use the right steering wheel control to open and scroll through the different items and displays.

Press \triangleleft to access the cluster applications. Use \triangle or ∇ to scroll through the list of applications.

- Info. This is where you can view the Driver Information Centre (DIC) displays. See *Driver Information Centre (DIC)* ⇨ 111.
- Performance
- Audio
- Phone
- Navigation (If Equipped)

- Settings

Performance

Press SEL to enter the Performance menu. Use \triangle or ∇ to scroll through the available items.

G-force : Gives the driver an indication of the vehicle performance in cornering. The G-force is displayed in the centre of the DIC as a numerical value.

Friction Bubble : A four quadrant visual display, indicative of the four corners of the car, with a “bubble” showing where the most inertia is being exerted on the vehicle.

Performance Timer : Press \triangleright when Performance Timer is displayed to enter the menu. Press \triangleright while Set Start Speed is highlighted then use \triangle or ∇ to enter the start speed. Press SEL to save it. Press \triangleright while Set End Speed is highlighted then use \triangle or ∇ to enter the end speed. Press SEL to save it. After the start and end speeds have been entered,

press \triangleleft to return to the DIC and follow the on-screen instructions. On the next acceleration, the performance time will record the time. To reset the timer, highlight Reset on the performance timer menu and press SEL.

Lap Timer : Press \triangleright when Lap Timer is displayed to start, stop, or reset the lap timer. A stopwatch icon will be displayed when the lap timer is active. Press SEL while the Lap Timer page is active to start the timer. If the lap timer is active, pressing SEL on any page will stop the current lap timer and start a new lap. Also, pressing and holding SEL on any page will stop the lap timer.

Coolant Temperature : Shows the current coolant temperature in either degrees Celsius ($^{\circ}\text{C}$) or degrees Fahrenheit ($^{\circ}\text{F}$).

Oil Temperature : Shows the current oil temperature in either degrees Celsius ($^{\circ}\text{C}$) or degrees Fahrenheit ($^{\circ}\text{F}$).

Oil Pressure : Shows the current oil pressure in either kilopascal (kPa) or in pounds per square inch (psi).

Battery Voltage : Shows the current battery voltage.

Transmission Fluid

Temperature : Shows the temperature of the transmission fluid in either degrees Celsius (°C) or degrees Fahrenheit (°F).

Tyre Temperature : Shows tyre temperature status as either Cold, Warm, or Hot. Warm is typical for normal driving while Hot is typical for aggressive driving. Unknown may be displayed if tyre temperature information is unavailable.

eLSD and Wheel Slip : Displays when the Electronic Limited-Slip Differential (eLSD) is active and intervening with the vehicle's normal operation. The display also displays slip percentage in a range of low, medium, and high. See *Limited-Slip Differential* ⇨ 193.

Audio

While the audio app is open, use \triangle or ∇ to change the radio station or seek to the next or previous track, depending on the current audio source. Press SEL to enter the Audio menu. In the Audio menu browse for music, select from the favourites, or change the audio source.

Phone

Press SEL to enter the Phone menu. In the Phone menu, if there is no active phone call, view recent calls, or scroll through contacts. If there is an active call, mute or unmute the phone or switch to handset or hands-free operation.

Navigation

If equipped, press SEL to enter the Navigation menu. Displays a map or turn by turn directions. If there is no active route, press \triangleright to resume the last route and turn the voice prompts on/off. If there is an active

route, press SEL to cancel route guidance or turn the voice prompts on/off.

Settings

Press SEL to enter the Settings menu. Use \triangle or ∇ to scroll through items in the Settings menu.

Units : Press \triangleright while Units is displayed to enter the Units menu. Choose US or Metric units by pressing SEL while the desired item is highlighted.

Display Theme : Press \triangleright to enter the Display Theme menu. Select from Link to Drive Mode, Track, Sport, or Tour for the cluster theme.

Speed Warning : The Speed Warning display allows the driver to set a speed that they do not want to exceed. To set the Speed Warning, press \triangleright when Speed Warning is displayed. Enable the speed warning and then use \triangle or ∇ to adjust the value. Press SEL to set the speed. Once the speed is set, this feature can be turned off by pressing SEL while viewing this

page. If the selected speed limit is exceeded, a pop-up warning is displayed with a chime.

Pocket Gauges : Press  while Pocket Gauges is displayed to enter the menu and select gauges that can be displayed for the Sport theme on the left or right of the display area. Choose from Oil Pressure Gauge, Oil Temperature Gauge, Battery Voltage, Gearbox Fluid Temperature Gauge, Horsepower or a blank gauge.

Software Info : Displays open source software information.

Speedometer

The speedometer shows the vehicle's speed in either kilometres per hour (km/h) or miles per hour (mph).

Mileometer

The odometer shows how far the vehicle has been driven, in either kilometres or miles.

Trip Odometer

The trip odometer shows how far the vehicle has been driven since the trip odometer was last reset.

The trip odometer is accessed and reset through the Driver Information Centre (DIC). See *Driver Information Centre (DIC)* ⇨ 111.

Rev Counter

The tachometer displays the engine speed in revolutions per minute (rpm).

Caution

If the engine is operated with the rpm in the warning area at the high end of the tachometer, the vehicle could be damaged, and the damage would not be covered by the vehicle warranty. Do not operate the engine with the rpm in the warning area.

Fuel Gauge

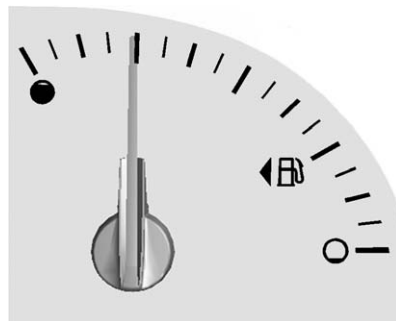

When the ignition is on, the fuel gauge indicates about how much fuel is left in the tank.

An arrow on the fuel gauge indicates the side of the vehicle the fuel door is on.

When the indicator nears empty, the low fuel light comes on. There is still a little fuel left, but the fuel tank should be filled soon.

Here are four things that some owners ask about. None of these show a problem with the fuel gauge:

- At the service station, the fuel pump shuts off before the gauge reads full.
- It takes a little more or less fuel to fill up than the gauge indicated. For example, the gauge indicated the tank was half full, but it actually took a little more or less than half the tank's capacity to fill the tank.
- The gauge moves a little while turning a corner or speeding up.
- The gauge takes a few seconds to stabilise after the ignition is turned on and goes back to empty when the ignition is turned off.

Engine Coolant Temperature Gauge

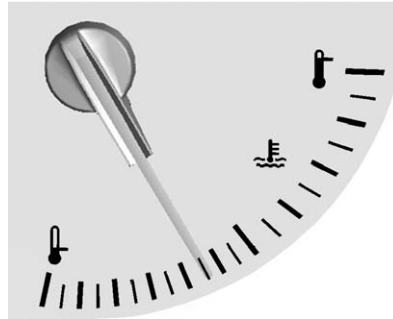

This gauge shows the engine coolant temperature.

If the gauge pointer moves to the high end, the engine is too hot.

This reading indicates the same thing as the warning light. It means that the engine coolant has overheated. If the vehicle has been operating under normal driving conditions, pull off the road, stop the vehicle, and turn off the engine as soon as possible. See *Engine Overheating* ⇨ 224.

Seat Belt Reminders

Driver Safety Belt Reminder Light

There is a driver safety belt reminder light on the instrument cluster.



When the vehicle is started, this light flashes and a chime may come on to remind the driver to fasten their safety belt. Then the light stays on solid until the belt is buckled. This cycle may continue several times if the driver remains or becomes unbuckled while the vehicle is moving.

If the driver safety belt is buckled, neither the light nor chime comes on.

Passenger Seat Belt Reminder Light

There is a passenger safety belt reminder light on the instrument panel cluster.



When the vehicle is started this light flashes and a chime may come on to remind passengers to fasten their safety belt. Then the light stays on solid until the belt is buckled. This cycle continues several times if the passenger remains or becomes unbuckled while the vehicle is moving.

If the passenger safety belt is fastened, neither the chime nor the light comes on.

The front passenger seat belt reminder light and chime may turn on if an object is put on the seat such as a briefcase, handbag, shopping bag, laptop or other

electronic device. To turn off the reminder light and/or chime, remove the object from the seat or buckle the safety belt.

Airbag Readiness Light

This light shows if there is an electrical problem with the airbag system. The system check includes the airbag sensor(s), passenger sensing system, the pretensioners, the airbag modules, the wiring, and the crash sensing and diagnostic module. For more information on the airbag system, see *Airbag System* ⇨ 64.



The airbag readiness light comes on for several seconds when the vehicle is started. If the light does not come on then, have it fixed immediately.

Warning

If the airbag readiness light stays on after the vehicle is started or comes on while driving, it means the airbag system might not be working properly. The airbags in the vehicle might not inflate in a crash, or they could even inflate without a crash. To help avoid injury, have the vehicle serviced right away.

If there is a problem with the airbag system, a Driver Information Centre (DIC) message may also come on. See *Airbag System Messages* ⇨ 124.

Passenger Airbag Status Indicator

The vehicle has a passenger sensing system. See *Passenger Sensing System* ⇨ 68 for important safety information. The passenger airbag status indicator is on the instrument panel.



When the vehicle is started, the passenger airbag status indicator will light the symbol for on and off for several seconds as a system check. Then, after several more seconds, the status indicator will light either the on or off symbol to let you know the status of the front outboard passenger frontal airbag.

If the on symbol is lit on the passenger airbag status indicator, it means that the front outboard passenger frontal airbag is allowed to inflate.

If the off symbol is lit on the airbag status indicator, it means that the passenger sensing system has turned off the front outboard passenger frontal airbag.

If, after several seconds, both status indicator lights remain on, or if there are no lights at all, there may be a problem with the lights or the passenger sensing system. See your retailer for service.

Warning

If the airbag readiness light ever comes on and stays on, it means that something may be wrong with the airbag system. To help avoid injury to yourself or others, have the vehicle serviced right away. See *Airbag Readiness Light* ⇨ 102 for more information, including important safety information.

Charging System Light

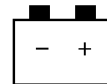

The charging system light comes on briefly when the ignition is turned on, but the engine is not running, as a check to show the light is working. It should go out when the engine is started.

If the light stays on or comes on while driving, there may be a problem with the electrical charging system. Have it checked by your dealer. Driving while this light is on could drain the battery.

When this light comes on, the Driver Information Centre (DIC) also displays a message. See *Battery Voltage and Charging Messages* ⇨ 117.

If a short distance must be driven with the light on, be sure to turn off all accessories, such as the radio and air conditioner.

Malfunction Indicator Lamp (Check Engine Light)

This light is part of the vehicle's emission control on-board diagnostic system. If this light is on while the engine is running, a malfunction has been detected and the vehicle may require service. The light should come on to show that it is working when the ignition is in Service Only Mode. See *Ignition Positions* ⇨ 167.

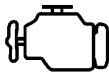

Malfunctions are often indicated by the system before any problem is noticeable. Being aware of the light and seeking service promptly when it comes on may prevent damage.

Caution

If the vehicle is driven continually with this light on, the emission control system may not work as well, the fuel economy may be lower, and the vehicle may not run smoothly. This could lead to costly repairs that might not be covered by the vehicle warranty.

Caution

Modifications to the engine, transmission, exhaust, intake, or fuel system, or the use of replacement tyres that do not meet the original tyre specifications, can cause this light to come on. This could lead to costly repairs not covered by the vehicle warranty. This could also affect the vehicle's ability to pass an Emissions Inspection/Maintenance test. See *Accessories and Modifications* ⇨ 203.

If the light is flashing : A malfunction has been detected that could damage the emission control system and increase vehicle emissions. Diagnosis and service may be required.

To help prevent damage, reduce vehicle speed and avoid hard accelerations and uphill gradients.

If the light continues to flash, find a safe place to park. Turn the vehicle off and wait at least 10 seconds before restarting the engine. If the light is still flashing, follow the previous guidelines and see your retailer for service as soon as possible.

If the light is on continuously : A malfunction has been detected. Diagnosis and service may be required.

Check the following:

- If fuel has been added to the vehicle using the capless funnel adapter, make sure that it has been removed. See "Filling the Tank with a Portable Gas Can" under *Filling the Tank* ⇨ 198.

The diagnostic system can detect if the adapter has been left installed in the vehicle, allowing fuel to evaporate into the atmosphere. A few driving trips with the adapter removed may turn off the light.

- Poor fuel quality can cause inefficient engine operation and poor driveability, which may go away once the engine is warmed up. If this occurs, change the fuel brand. It may require at least one full tank of the proper fuel to turn the light off. See *Fuel* ⇨ 197.

If the light remains on, see your retailer.

Emissions Inspection and Maintenance Programs

If the vehicle requires an Emissions Inspection/Maintenance test, the test equipment will likely connect to the vehicle's Data Link Connector (DLC).



The DLC is under the instrument panel to the left of the steering wheel. Connecting devices that are not used to perform an Emissions Inspection/Maintenance test or to service the vehicle may affect vehicle operation. See *Add-On Electrical Equipment* ⇨ 201. See your dealer if assistance is needed.

The vehicle may not pass inspection if:

- The light is on when the engine is running.
- The light does not come on when the ignition is in Service Only Mode.
- Critical emission control systems have not been completely diagnosed. If this happens, the vehicle would not be ready for inspection and might require several days of routine driving

before the system is ready for inspection. This can happen if the 12-volt battery has recently been replaced or run down, or if the vehicle has been recently serviced.

See your retailer if the vehicle will not pass or cannot be made ready for the test.

Brake System Warning Light

The vehicle brake system consists of two hydraulic circuits. If one circuit is not working, the remaining circuit can still work to stop the vehicle. For normal braking performance, both circuits need to be working.

If the warning light comes on, there is a problem with the braking system. Have the brake system inspected immediately.



This light should come on briefly when the engine is started. If it does not come on then, have it fixed so it will be ready to warn you if there is a problem.

If the light comes on and stays on, there is a basic braking system problem.

Warning

The brake system might not be working properly if the brake system warning light is on. Driving with the brake system warning light on can lead to a crash. If the light is still on after the vehicle has been pulled off the road and carefully stopped, have the vehicle towed for service.

Electric Parking Brake Light



The parking brake status light comes on when the parking brake is applied. If the light continues flashing after the parking brake is released, or while driving, there is a problem with the electric parking brake system or another system. A message may also display in the Driver Information Centre (DIC). See *Brake System Messages* ⇨ 117.

If the light does not come on, or remains flashing, see your dealer.

Service Electric Parking Brake Light



The service electric parking brake light should come on briefly when starting the vehicle. If it does not come on, have the vehicle serviced by your dealer.

If this light stays on, there is a problem with a system on the vehicle that is causing the parking brake system to work at a reduced level. The vehicle can still be driven, but should be taken to a dealer as soon as possible. See *Electric Parking Brake* ⇨ 182. If a message displays in the Driver Information Centre (DIC), see *Brake System Messages* ⇨ 117.

Antilock Brake System (ABS) Warning Light



This light comes on briefly when the engine is started.

If the light does not come on, have it fixed so it will be ready to warn if there is a problem.

If the light comes on while driving, stop as soon as it is safely possible and turn off the vehicle. Then start the engine again to reset the system. If the ABS light stays on, or comes on again while driving, the vehicle needs service. A chime may also sound when the light comes on steady.

If the ABS light is the only light on, the vehicle has regular brakes, but the anti-lock brakes are not functioning.

If both the ABS and the brake system warning light are on, the vehicle's anti-lock brakes are not functioning and there is a problem with the regular brakes. See your retailer for service.

See *Brake System Warning Light*
 ⇨ 105 and *Brake System Messages*
 ⇨ 117.

Gear Shifting Light



This light comes on when a gear shift is recommended for best fuel economy. When the arrow is pointed up, an upshift is recommended. When the arrow is pointed down, a downshift is recommended. The number displayed with the arrow indicates the recommended gear.

Traction Off Light



This light comes on briefly while starting the engine. If it does not, have the vehicle serviced by your dealer. If the system is working normally, the indicator light then turns off.

The traction off light comes on when the Traction Control System (TCS) has been turned off by pressing and releasing the TCS/Stability Control button.

This light and the Electronic Stability Control (ESC) OFF light come on when ESC is turned off.

If the TCS is off, wheel spin is not limited. Adjust driving accordingly.

See *Traction Control/Electronic Stability Control* ⇨ 185.

Traction Control System (TCS)/Electronic Stability Control Light



If equipped, the Electronic Stability Control (ESC) or TCS indicator/warning light comes on briefly when the engine is started.

If the light does not come on, have the vehicle serviced by your dealer. If the system is working normally, the indicator light turns off.

If the light is on and not flashing, the TCS, and potentially the ESC system have been disabled.

If the indicator/warning light is on and flashing, the TCS and/or the ESC system is actively working.

See *Traction Control/Electronic Stability Control* ⇨ 185.

Electronic Stability Control (ESC) Off Light



This light comes on briefly while starting the engine. If it does not, have the vehicle serviced by your dealer.

This light comes on when the ESC system is turned off. If ESC is off, the Traction Control System (TCS) is also off.

If the ESC and TCS are off, the system does not assist in controlling the vehicle. Turn on the TCS and the ESC systems and the warning light turns off.

See *Traction Control/Electronic Stability Control* ⇨ 185.

Engine Coolant Temperature Warning Light



This light comes on briefly while starting the vehicle.

If it does not, have the vehicle serviced by your dealer. If the system is working normally the indicator light goes off.

Caution

The engine coolant temperature warning light indicates that the vehicle has overheated. Driving with this light on can damage the engine and it may not be covered by the vehicle warranty. See *Engine Overheating* ⇨ 224.

The engine coolant temperature warning light comes on when the engine has overheated.

If this happens, pull over and turn off the engine as soon as possible. See *Engine Overheating* ⇨ 224.

Tyre Pressure Light



For vehicles with the Tyre Pressure Monitor System (TPMS), this light comes on briefly when the engine is started. It provides information about tyre pressures and the TPMS.

When the Light Is On Steady

This indicates that one or more of the tyres are significantly underinflated.

A Driver Information Centre (DIC) tyre pressure message may also display. See *Tyre Messages* ⇨ 125. Stop as soon as possible, and

inflate the tyres to the pressure value shown on the Tyre and Loading Information label. See *Tyre Pressure* ⇨ 249.

When the Light Flashes First and Then Is On Steady

If the light flashes for about a minute and then stays on, there may be a problem with the TPMS. If the problem is not corrected, the light will come on at every ignition cycle. See *Tyre Pressure Monitor Operation* ⇨ 252.

Engine Oil Pressure Light

Caution

Lack of proper engine oil maintenance can damage the engine. Driving with the engine oil low can also damage the engine. The repairs would not be covered by the vehicle warranty. Check the oil level as soon as possible. Add oil if required, but if the oil level is within the operating range

(Continued)

Caution (Continued)

and the oil pressure is still low, have the vehicle serviced. Always follow the maintenance schedule for changing engine oil.



This light should come on briefly as the engine is started. If it does not come on, have the vehicle serviced by your dealer.

If the light comes on and stays on, it means that oil is not flowing through the engine properly. The vehicle could be low on oil and might have some other system problem. See your dealer.

Low Fuel Warning Light



This light is near the fuel gauge and comes on briefly when the ignition is turned on as a check to show it is working.

It also comes on when the fuel tank is low on fuel. The light turns off when fuel is added. If it does not, have the vehicle serviced.

Security Light



The security light should come on briefly as the engine is started. If it does not come on, have the vehicle

serviced by your dealer. If the system is working normally, the indicator light turns off.

If the light stays on and the engine does not start, there could be a problem with the theft-deterrent system. See *Immobiliser Operation* ⇨ 38.

Main-Beam On Light



This light comes on when the high-beam headlamps are in use.

See *Headlamp Main/Dipped-Beam Changer* ⇨ 134.

Rear Fog Lamp Light



This light comes on when the rear fog lamps are in use.

For more information see *Rear Fog Lamps* ⇨ 136.

Lamps On Reminder



This light comes on when the exterior lamps are in use. See *Exterior Lamp Controls* ⇨ 133.

Cruise Control Light



For vehicles with cruise control, the cruise control light is white when the cruise control is on and ready, and turns green when the cruise control is set and active.

The light turns off when the cruise control is turned off. See *Cruise Control* ⇨ 193.

Door Ajar Light



This light comes on when a door is open or not securely latched. Before driving, check that all doors are properly closed.

Information Displays

Driver Information Centre (DIC)

The DIC displays are shown in the centre of the instrument cluster in the Info application. See *Instrument Cluster* ⇨ 95. Info is only available when the vehicle is in ON/RUN. The displays show the status of many vehicle systems. The controls for the DIC are on the right steering wheel control.

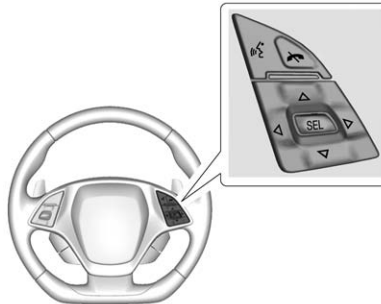

△ or ▽ : Press to move up or down in a list.

◀ or ▶ : Press ◀ to open application menus on the left. Press ▶ to open interaction menus on the right.

SEL (Select) : Press to open a menu or select a menu item. Press and hold to reset values on certain screens.

DIC Info Pages

The following is the list of all possible DIC info displays. Depending on the vehicle, some may not be available.

Current Speed : Displays the vehicle speed in either kilometres per hour (km/h) or miles per hour (mph).

Trip A or B/Average Fuel Economy/Average Speed : Trip displays the current distance travelled, in either kilometres (km) or miles (mi), since the trip odometer was last reset. The trip odometer can be reset by pressing and holding SEL while this display is active.

Average Fuel Economy displays the approximate average litres per 100 kilometres (L/100 km) or miles per gallon (mpg). This number is calculated based on the number of L/100 km (mpg) recorded since the last time this menu item was reset. This number reflects only the approximate average fuel economy that the vehicle has right now, and will change as driving conditions change. The Average Fuel Economy can be reset by pressing and holding SEL while this display is active.

Average Speed displays the average speed of the vehicle in kilometres per hour (km/h) or miles per hour (mph). This average is calculated based on the various vehicle speeds recorded since the last reset of this value. The average speed can be reset by pressing and holding SEL while this display is active.

Fuel Range/Instantaneous Fuel Economy : Fuel Range displays the approximate distance the vehicle can be driven without refuelling. LOW will be displayed when the

vehicle is low on fuel. The fuel range estimate is based on an average of the vehicle's fuel economy over recent driving history and the amount of fuel remaining in the fuel tank.

Instantaneous Fuel Economy displays the current fuel economy in either litres per 100 kilometres (L/100 km) or miles per gallon (mpg). This number reflects only the approximate fuel economy that the vehicle has right now and changes frequently as driving conditions change.

This display may also show the number of cylinders the vehicle is running on. See *Active Fuel Management*[®] ⇨ 173.

Oil Life : Displays an estimate of the oil's remaining useful life. If REMAINING OIL LIFE 99% is displayed, that means 99% of the current oil life remains.

When the remaining oil life is low, the CHANGE ENGINE OIL SOON message will appear on the display. See *Engine Oil Messages* ⇨ 120. The oil should be changed as soon

as possible. See *Engine Oil* ⇨ 211. In addition to the engine oil life system monitoring the oil life, additional maintenance is recommended in the Maintenance Schedule booklet.



The Oil Life display must be reset after each oil change. It will not reset itself. Do not reset the Oil Life display accidentally at any time other than when the oil has just been changed. It cannot be reset accurately until the next oil change. To reset the engine oil life system, press and hold SEL for several seconds while the Oil Life display is active. See *Engine Oil Life System* ⇨ 216.

Tyre Pressure : Displays the approximate pressures of all four tyres. Tyre pressure is displayed in either kilopascal (kPa) or in pounds per square inch (psi). If the pressure is low, the value for that tyre is shown in amber. See *Tyre Pressure Monitor System* ⇨ 251 and *Tyre Pressure Monitor Operation* ⇨ 252.

Best Average Fuel Economy :

Displays the average fuel economy, the best fuel economy over the selected distance, and a bar graph showing instantaneous fuel economy. Press  to change the selected distance.

Fuel Used/Timer : Displays the approximate litres (L) or gallons (gal) of fuel that have been used since last reset. The fuel used can be reset by pressing and holding SEL while this display is active.

This display can also be used as a timer. To start/stop the timer, press  while this display is active and then SEL to start/stop the timer. The display will show the amount of time that has passed since the timer was last reset. To reset the timer to zero, press and hold SEL or use  to access the menu while this display is active.

ECO Index : Aids the driver in determining how efficiently they are driving.

This display may also show the number of cylinders the vehicle is running on. See *Active Fuel Management*[®] ⇨ 173.

Speed Limit : Displays sign information, which comes from a roadway database in the onboard navigation.

Engine Hours/Lifetime Revs : Displays the total number of hours the engine has run. It also shows total engine revolutions divided by 10,000.

Head-Up Display (HUD) **Warning**

If the HUD image is too bright or too high in your field of view, it may take you more time to see things you need to see when it is dark outside. Be sure to keep the HUD image dim and placed low in your field of view.

If the vehicle is equipped with HUD, some information concerning the operation of the vehicle is projected onto the windscreen.

The HUD information appears as an image focused out toward the front of the vehicle.

Caution

If you try to use the HUD image as a parking aid, you may misjudge the distance and damage your vehicle. Do not use the HUD image as a parking aid.

The HUD information can be displayed in various languages. The speedometer reading and other numerical values can be displayed in either English or metric units.

The language selection is changed through the radio and the units of measurement is changed through the instrument cluster. See *Vehicle Personalisation* ⇨ 127 and “Settings” under *Instrument Cluster* ⇨ 95.

The HUD may display different alerts and information for vehicles equipped with these features:

- Speedometer
- Rev Counter
- Shift Light

This light is used for performance driving to indicate that the vehicle's best performance level has been reached to shift the transmission into the next higher gear. An arrow pointing up will light up on the display just prior to reaching the engine fuel cut-off mode.

- Lap Timer
- G-Force Meter
- Audio Information
- Upcoming Manoeuvre from OnBoard Navigation
- Incoming Call

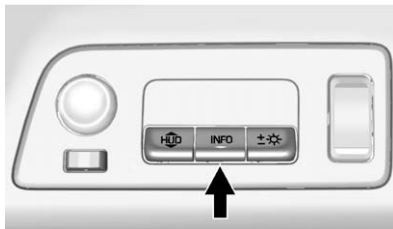

The HUD control is to the left of the steering wheel on the instrument panel.

To adjust the HUD image so that items are properly displayed:

1. Adjust the driver seat.
2. Start the engine.

Use the following settings to adjust the HUD.

HUD (Image Adjustment) : Lift up or press down to adjust the HUD image up or down.

INFO (Display View) : Press to select the display view. Each press will cause the display view to change to the next view. If vehicle messages are displayed, pressing

the DIC select button may clear the message. See *Driver Information Centre (DIC)* ⇨ 111.

±☀ (Image Brightness) : Lift up and hold to brighten the display. Press down and hold to dim the display. Hold down to turn the display off.

The HUD image will automatically dim and brighten to compensate for outside lighting. The HUD brightness control can also be adjusted as needed.

The HUD image can temporarily light up depending on the angle and position of the sunlight on the HUD display. This is normal.

Polarised sunglasses could make the HUD image harder to see.

Display Views

There are several HUD views that can be displayed:



Tour : Displays the vehicle speed, gear position, and shift indicator.



Sport : Displays the vehicle speed, a circular tachometer, shift indicator, and G-Force meter.

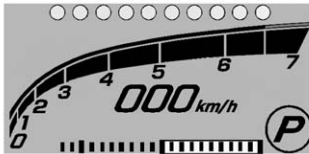

Track : Displays the vehicle speed, a linear tachometer, gear position, shift lights, and G-Force meter.



Timing : Displays a linear tachometer, gear position, shift lights, and performance or lap timer. The performance or lap timer content displayed depends on which feature is currently in use in the instrument cluster. See *Instrument Cluster* ⇨ 95.

Interrupts

The interrupt information temporarily displays in any HUD view. Once displayed, HUD returns to the previous HUD view. Interrupts may include:

- Audio Information
- Navigation Turn-by-Turn Information

- Incoming Call Information
- Vehicle Alerts



Audio : May display when a new source, radio station, or media type is selected.

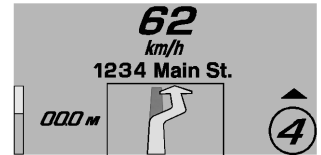

Navigation : Turn-by-turn navigation information may be displayed when Navigation is active and an upcoming manoeuvre is pending. It appears until the manoeuvre is complete and then the HUD display returns to the previous view.



Phone : May display when an incoming call is received from a Bluetooth connected phone. It appears momentarily until the call is answered or ignored.

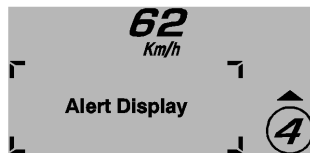

Vehicle Alerts : Alerts can be dismissed in the instrument cluster. All alerts are not displayed in the HUD.

Care of the HUD

Clean the inside of the windscreen to remove any dirt or film that could reduce the sharpness or clarity of the HUD image.

Clean the HUD lens with a soft cloth sprayed with glass cleaner. Wipe the lens gently, then dry it.

HUD Troubleshooting

Check that:

- Nothing is covering the HUD lens.
- HUD brightness setting is not too dim or too bright.
- HUD is adjusted to the proper height.
- Polarised sunglasses are not worn.
- Windscreen and HUD lens are clean.

If the HUD image is not correct, contact your dealer.

The windscreen is part of the HUD system. See *Windscreen Replacement* ⇨ 236.

Vehicle Messages

Messages displayed on the DIC indicate the status of the vehicle or some action that may be needed to correct a condition. Multiple messages may display one after the other.

The messages that do not require immediate action can be acknowledged and cleared by pressing SEL. The messages that require immediate action cannot be cleared until that action is performed. All messages should be taken seriously and clearing the messages does not correct the problem.

The following are some of the vehicle messages that may be displayed depending on the vehicle content.

Battery Voltage and Charging Messages

BATTERY SAVER ACTIVE

This message displays when the vehicle has detected that the battery voltage is dropping beyond a reasonable point. The battery saver system starts reducing features of the vehicle that may be noticed. At the point that features are disabled, this message displays. Turn off unnecessary accessories to allow the battery to recharge.

LOW BATTERY

This message is displayed when the battery voltage is low. See *Battery* ⇨ 228.

SERVICE BATTERY CHARGING SYSTEM

This message is displayed when there is a fault in the battery charging system. Take the vehicle to your dealer for service.

Brake System Messages

BRAKE FLUID LOW

This message is displayed when the brake fluid level is low. See *Brake Fluid* ⇨ 227.

RELEASE PARKING BRAKE

This message is displayed if the Electric Parking Brake is on while the vehicle is in motion. See *Electric Parking Brake* ⇨ 182.

SERVICE BRAKE ASSIST

This message may be displayed when there is a problem with the brake boost assist system. When this message is displayed, the brake boost assist motor might be heard operating and you might notice pulsation in the brake pedal. This is normal under these conditions. Take the vehicle to your dealer for service.

SERVICE PARKING BRAKE

This message is displayed when there is a problem with the parking brake. Take the vehicle to your dealer for service.

STEP ON BRAKE TO RELEASE PARK BRAKE

This message is displayed if you attempt to release the Electric Parking Brake without the brake pedal applied. See *Electric Parking Brake* ⇨ 182.

Compass Messages

Dashes may be displayed if the vehicle temporarily loses communication with the Global Positioning System (GPS).

Convertible Top Messages

The following messages are for vehicles with a power convertible top.

ATTACH TRUNK PARTITION TO OPERATE TOP

This message displays and a sound will be heard if the boot partition is not in place. Open the hatch/boot and make sure the boot partition is secure and no objects are on the boot partition.

BATTERY VOLTAGE TOO LOW – TOP DISABLED

This message displays when the battery voltage is too low to operate the convertible top.

CLOSE BOOT TO MOVE TOP

This message displays if the boot is open while you are trying to operate the convertible top. Make sure the boot is closed before operating the convertible top.

FOLDING TOP MOTION COMPLETE

This message displays when the top successfully completes an open/close cycle.

FOLDING TOP NOT SECURE COMPLETE TOP MOTION

This message occurs if the top is not secure. Several beeps will sound. Complete the power open or power close cycle for the top. If it is not possible to move the top to a fully open or fully closed position,

make sure that all objects are clear of the path of the top system components.

ONLY MANUAL OPERATION OF TOP POSSIBLE

This message indicates that the position of the top cannot be fully determined by the power convertible top controls. Try moving the top in the other direction. This message will also be displayed if a fault is detected by the convertible top controls. See “Manual Movement of Top” under *Convertible Top* ⇨ 46.

REDUCE VEHICLE SPEED TO OPERATE TOP

This message is displayed when the vehicle speed exceeds or is approaching the convertible top speed cut off.

TEMPERATURE TOO LOW – TOP DISABLED

This message displays and a sound will be heard when the power convertible top button is pressed and it is too cold to operate the power convertible top. Move the

vehicle to a warmer location and wait for the vehicle temperature to rise. This may take several hours depending on the initial vehicle temperature and the temperature of the new location.

TOP NOT SECURE

This message displays when the power convertible top is not completely opened or closed. Press and hold the convertible top button until the top is fully opened or closed. This is indicated by the FOLDING TOP MOTION COMPLETE message being displayed and an audible indicator.

TOP POWERING DOWN COMPLETE TOP MOTION

This message displays when the power convertible top can no longer hold the top in an intermediate position. Top system components may move during this time based on external forces. Keep objects clear from the normal path of movement for the top system components.

**TOP SYSTEM OVERHEATED,
PLEASE WAIT**

This message displays and a sound will be heard when the power convertible top button is pressed and the power convertible top pump motor temperature is overheated. Wait for the power convertible top pump motor to cool down before using the power convertible top.

**VALET SWITCH ACTIVE – TOP
DISABLED**

This message displays when Valet Mode is active.

Cruise Control Messages**CRUISE SET TO XXX**

This message displays when the cruise control is set and shows the speed it was set to. See *Cruise Control* ⇨ 193.

Door Ajar Messages**DOOR OPEN**

A door open symbol will display on the DIC showing which door is open. The DOOR OPEN message may also display if the vehicle starts to move. Close the door completely.

BONNET OPEN

This message will display along with a bonnet open symbol when the bonnet is open. Close the bonnet completely.

BOOT LID OPEN

This message will display along with a symbol when the boot is open. Close the boot completely.

**Engine Cooling System
Messages****A/C OFF DUE TO HIGH
ENGINE TEMP**

This message displays when the engine coolant becomes hotter than the normal operating temperature. To avoid added strain on a hot

engine, the air conditioning compressor automatically turns off. When the coolant temperature returns to normal, the air conditioning compressor turns back on. The vehicle can continue to be driven.

If this message continues to appear, have the system repaired by your dealer as soon as possible to avoid damage to the engine.

**ENGINE OVERHEATING —
IDLE ENGINE**

This message displays when the engine coolant temperature is too hot. Stop and allow the vehicle to idle until it cools down.

**ENGINE OVERHEATED —
TURN VEHICLE OFF**

This message displays and a continuous chime sounds if the engine cooling system reaches unsafe temperatures for operation. Stop and turn off the vehicle as soon as it is safe to do so to avoid severe damage. This message clears when the engine has cooled to a safe operating temperature.

Engine Oil Messages

CHANGE ENGINE OIL SOON

This message displays when the engine oil needs to be changed. When you change the engine oil, be sure to reset the Oil Life System. See *Engine Oil Life System* ⇨ 216, *Driver Information Centre (DIC)* ⇨ 111, *Engine Oil* ⇨ 211, and the Maintenance Schedule booklet.

ENGINE OIL HOT, IDLE ENGINE

This message displays when the engine oil temperature is too hot. Stop and allow the vehicle to idle until it cools down.

ENGINE OIL LOW — ADD OIL

On some vehicles, this message displays when the engine oil level may be too low. Check the oil level before filling to the recommended level. If the oil is not low and this message remains on, take the vehicle to your dealer for service. See *Engine Oil* ⇨ 211.

OIL PRESSURE LOW — STOP ENGINE

This message displays if low oil pressure levels occur. Stop the vehicle as soon as safely possible and do not operate it until the cause of the low oil pressure has been corrected. Check the oil as soon as possible and have the vehicle serviced by your dealer.

OIL STARVATION MODE ACTIVE

This message indicates the engine controls have taken action to prevent an oil starvation condition. This may reduce the available engine power.

Engine Power Messages

ENGINE POWER IS REDUCED

This message displays when the vehicle's engine power is reduced. Reduced engine power can affect the vehicle's ability to accelerate. If this message is on, but there is no reduction in performance, proceed to your destination. The

performance may be reduced the next time the vehicle is driven. The vehicle may be driven at a reduced speed while this message is on, but maximum acceleration and speed may be reduced. Anytime this message stays on, the vehicle should be taken to your dealer for service as soon as possible.

Fuel System Messages

FUEL LEVEL LOW

This message displays when the vehicle is low on fuel. Refuel as soon as possible.

Key and Lock Messages

KEYS PROGRAMMED

This message displays when programming new keys to the vehicle.

NO REMOTE DETECTED

This message displays when the transmitter battery may be weak. See "Starting the Vehicle with a Low

Transmitter Battery” under *Remote Keyless Entry (RKE) System Operation* ⇨ 25.

NO REMOTE KEY WAS DETECTED PLACE KEY IN TRANSMITTER POCKET THEN START YOUR VEHICLE

This message displays when trying to start the vehicle if an RKE transmitter is not detected. The transmitter battery may be weak. See “Starting the Vehicle with a Low Transmitter Battery” under *Remote Keyless Entry (RKE) System Operation* ⇨ 25.

NO REMOTE PRESS BRAKE TO RESTART

This message displays if the RKE transmitter is no longer detected in the vehicle. Press the brake pedal to restart the vehicle.

REMOTE LEFT IN VEHICLE

This message displays when leaving the vehicle with the RKE transmitter still inside.

REPLACE BATTERY IN REMOTE KEY

This message displays when the battery in the RKE transmitter needs to be replaced.

Lamp Messages

AUTOMATIC LIGHT CONTROL ON/OFF

This message is displayed when the automatic light control has been turned on or off. See *Automatic Headlamp System* ⇨ 135.

INDICATOR ON

This message is displayed if the indicator has been left on. Turn off the indicator.

Ride Control System Messages

STABILITRAK COMPETITIVE MODE

This message displays and a sound will be heard when the Competitive Driving mode is selected. The instrument cluster light will be on

when the Competitive Driving mode is selected. Launch Control is available when this mode is selected. The Traction Control System (TCS) will not be operating while in the Competitive Driving mode. Adjust your driving accordingly. See *Competitive Driving Mode* ⇨ 190, including the “Launch Control” information.

MAXIMUM SPEED 129 km/h (80 MPH)

This message displays when a malfunction is present in the Magnetic Ride Control system. The vehicle speed will be limited to a value determined by the vehicle when the shock absorber system has failed and the shocks are in their full soft mode. Have the vehicle serviced by your dealer as soon as possible.

To acknowledge the message, press the SEL button. The message reappears every 10 minutes until this condition changes.

**PERFORMANCE TRACTION
WET ACTIVE HANDLING ON**

This message displays and a sound will be heard when this Performance Traction Management mode is selected. The instrument cluster light will also be on when this mode is selected. Launch Control is available when this mode is selected. In this mode the Traction Control and Stability Control systems are available but intended for use on wet race track conditions. Adjust your driving accordingly. This mode is available only on Z06 models and models with FE4 – Z51 Performance Package and Magnetic Ride Control. See “Performance Traction Management” and “Launch Control” under *Competitive Driving Mode* ⇨ 190 for more information about the use of this mode.

**PERFORMANCE TRACTION
DRY ACTIVE HANDLING ON**

This message displays and a sound will be heard when this Performance Traction Management mode is selected. The instrument cluster

light will also be on when this mode is selected. Launch Control is available when this mode is selected. In this mode the Traction Control and Stability Control systems are available but intended for use on dry race track conditions. Adjust your driving accordingly. This mode is available only on Z06 models and models with FE4. See “Performance Traction Management” and “Launch Control” under *Competitive Driving Mode* ⇨ 190 for more information about the use of this mode.

**PERFORMANCE TRACTION
SPORT 1 ACTIVE
HANDLING ON**

This message displays and a sound will be heard when this Performance Traction Management mode is selected. The instrument cluster light will also be on when this mode is selected. Launch Control is available when this mode is selected. In this mode the Traction Control and Stability Control systems are available but intended for use on dry race track conditions.

Adjust your driving accordingly. This mode is available only on Z06 models and models with FE4. See “Performance Traction Management” and “Launch Control” under *Competitive Driving Mode* ⇨ 190 for more information about the use of this mode.

**PERFORMANCE TRACTION
SPORT 2 ACTIVE
HANDLING OFF**

This message displays and a sound will be heard when this Performance Traction Management mode is selected. The instrument cluster light will also be on when this mode is selected. Launch Control is available when this mode is selected. In this mode the Traction Control is available but intended for use on dry race track conditions. The Stability Control system is disabled when this mode is selected. This mode will require more driver skill than modes 1-3. Adjust your driving accordingly. This mode is available only on Z06 models and models with FE4. See “Performance Traction

Management” and “Launch Control” under *Competitive Driving Mode* ⇨ 190 for more information about the use of this mode.

PERFORMANCE TRACTION RACE ACTIVE HANDLING OFF

This message displays and a sound will be heard when this Performance Traction Management mode is selected. The instrument cluster light will also be on when this mode is selected. Launch Control is available when this mode is selected. In this mode the Traction Control is available but intended for use on dry race track conditions. The Stability Control system is disabled when this mode is selected. This mode will require more driver skill than modes 1-4. Adjust your driving accordingly. This mode is available only on Z06 models and models with FE4. See “Performance Traction Management” and “Launch Control” under *Competitive Driving Mode* ⇨ 190 for more information about the use of this mode.

REAR AXLE OFF

If this message is displayed, the Electronic Limited-Slip Differential (if equipped) is not operational. Drive with caution. Avoid high speeds, aggressive driving, and sharp cornering. The system could be overheated. Allow the system to cool. If this message remains on, see your dealer for service. The vehicle is safe to drive, however, continue to drive with caution.

When this message is displayed, the vehicle's handling capabilities will be reduced during severe manoeuvres. Stability Control will be affected. See *Traction Control/Electronic Stability Control* ⇨ 185.

SERVICE STABILITRAK

This message displays if there is a problem with the Stability Control system and the vehicle needs service. The Stability Control system light on the instrument cluster also turns on and a sound will be heard. See your dealer. When this message is displayed, the system is not working. Adjust

your driving accordingly. See *Traction Control/Electronic Stability Control* ⇨ 185.

SERVICE TRACTION SYSTEM

If this message displays when you are driving, there is a problem with the Traction Control System (TCS) and the vehicle needs service. See your dealer. When this message is displayed, the system will not limit wheel spin. Adjust your driving accordingly.

The TCS light on the instrument cluster will also turn on and a sound will be heard.

When this message is displayed, the computer controlled systems will not assist the driver in controlling the vehicle. Have the system repaired by your dealer as soon as possible. Adjust your driving accordingly. See *Traction Control/Electronic Stability Control* ⇨ 185.

To acknowledge the message, press the SEL button.

SHOCKS INOPERATIVE

This message displays when a malfunction is present in the Magnetic Ride Control system, which is causing the shocks to be in their full soft mode. This is a warning to the driver that the vehicle handling may be affected. Have the vehicle serviced by your dealer as soon as possible.

To acknowledge the message, press the SEL button. The message reappears every 10 minutes until this condition changes.

Airbag System Messages

SERVICE AIRBAG

This message displays if there is a problem with the airbag system. See your retailer for service.

Security Messages

THEFT ATTEMPTED

This message displays if the vehicle detects a tamper condition.

Service Vehicle Messages

PROGRAM CLUSTER

This message is displayed if there is a problem with the instrument cluster. Take the vehicle to your dealer for service.

SERVICE POWER STEERING

This message displays and a chime may sound when there may be a problem with the power steering system. If this message displays and a reduction in steering performance or loss of power steering assistance is noticed, see your retailer.

SERVICE REAR AXLE

If there is a problem detected with the Electronic Limited-Slip Differential, this message displays. When displayed, the system is not operational and driving should be adjusted accordingly. Take the vehicle to your dealer for service as soon as possible.

When this message is displayed, the vehicle's handling capabilities will be reduced during severe

manoeuvres. Stability Control will be affected. See *Traction Control/Electronic Stability Control* ⇨ 185.

SERVICE VEHICLE SOON

This message is displayed if there is a problem with the vehicle. Take the vehicle to your dealer for service.

Starting the Vehicle Messages

PRESS BRAKE TO START

This message is displayed when attempting to start an automatic transmission equipped vehicle without first pressing the brake pedal.

PRESS CLUTCH TO START

This message is displayed when attempting to start a manual gearbox equipped vehicle without first pressing the clutch pedal.

SERVICE KEYLESS START SYSTEM

This message is displayed if there is a problem with the pushbutton start system. Take the vehicle to your dealer for service.

Tyre Messages

SERVICE TYRE MONITOR SYSTEM

This message displays if there is a problem with the Tyre Pressure Monitor System (TPMS). See *Tyre Pressure Monitor Operation* ⇨ 252.

TYRE LEARNING ACTIVE

This message displays when the system is learning new tyres. See *Tyre Pressure Monitor Operation* ⇨ 252.

TYRE PRESSURE LOW ADD AIR TO TYRE

This message displays when the pressure in one or more of the tyres is low.

This message also displays LEFT FRONT, RIGHT FRONT, LEFT REAR, or RIGHT REAR to indicate the location of the low tyre.

The low tyre pressure warning light will also come on. See *Tyre Pressure Light* ⇨ 109.

If a tyre pressure message appears on the DIC, stop as soon as you can. Inflate the tyres by adding air until the tyre pressure is equal to the values shown on the Tyre and Loading Information label. See *Tyres* ⇨ 245, *Vehicle Load Limits* ⇨ 162, and *Tyre Pressure* ⇨ 249.

You can receive more than one tyre pressure message at a time. The DIC also shows the tyre pressure values. See *Driver Information Centre (DIC)* ⇨ 111.

Transmission Messages

SERVICE TRANSMISSION

This message displays if there is a problem with the transmission. See your dealer.

SHIFT DENIED

This message displays when attempting to shift to a gear not appropriate for the vehicle speed and engine revolutions per minute (rpm).

TRANSMISSION HOT — IDLE ENGINE

This message displays and a chime sounds if the transmission fluid in the vehicle gets hot. Driving with the transmission fluid temperature high can cause damage to the vehicle. Stop the vehicle and let it idle to allow the transmission to cool. This message clears when the fluid temperature reaches a safe level.

If this message is displayed during normal vehicle operation on flat roads, the vehicle may need service. See your retailer for an inspection.

Vehicle Reminder Messages

ICE POSSIBLE DRIVE WITH CARE

This message is displayed when ice conditions are possible.

TURN WIPER CONTROL TO INTERMITTENT FIRST

This message is displayed when attempting to adjust the intermittent wiper speed without intermittent selected on the wiper control. See *Windscreen Wiper/Washer* ⇨ 91.

Vehicle Speed Messages

SPEED LIMIT EXCEEDED

This message is displayed when the vehicle speed is greater than the speed warning speed. See "Speed Warning" under *Instrument Cluster* ⇨ 95.

SPEED LIMIT SET TO XXX

This message is displayed when the speed warning is set. See "Speed Warning" under *Instrument Cluster* ⇨ 95.

Washer Fluid Messages

WASHER FLUID LOW ADD FLUID

This message may display when the washer fluid level is low. Fill the windscreen washer reservoir as soon as possible. See *Engine Compartment Overview* ⇨ 208 for the location of the windscreen washer reservoir. Also, see *Washer Fluid* ⇨ 225.

Window Messages

OPEN, THEN CLOSE DRIVER/PASSENGER WINDOW

This message is displayed when the window needs to be reprogrammed. If the vehicle's battery has been recharged or disconnected, you will need to program each front window for the express-up feature to work. See *Power Windows* ⇨ 41.

Vehicle Personalisation

Use the audio system controls to access the personalisation menus for customising vehicle features.

The following are all possible personalisation features. Depending on the vehicle, some may not be available.

Infotainment System Audio System Controls

To access the personalisation menu:

1. Press **SETTINGS** on the Home Page on the infotainment system display.
2. Press the desired feature to display a list of available options.
3. Press to select the desired feature setting.
4. Press  **BACK** on the faceplate or press the Back screen button to return to the previous menu.

Personalisation Menus

The following list of menu items may be available:

- Time and Date
- Driving Mode
- Language (Language)
- Valet Mode
- Radio
- Vehicle
- Bluetooth
- Voice
- Display
- Rear Camera
- Return to Factory Settings
- Software Information

Each menu is detailed in the following information.

Time and Date

Manually set the time and date. See *Clock* ⇨ 93.

Driving Mode

Select and the following may be displayed:

- Engine Sound Management
- Steering

Engine Sound Management

This allows the Engine Sound Management feature to be set independent of the driver mode selector. See *Track Events and Competitive Driving* ⇨ 154.

Select Auto (Mode Selector) or Stealth, Tour, Sport, or Track.

Steering

This allows the Steering feature to be turned on or off.

Select Auto (Mode Selector), Tour, Sport, or Track.

Language (Language)

Select Language [Language], then select from the available language(s).

The selected language will display on the system, and voice recognition will reflect the selected language.

Valet Mode (If Equipped)

This will lock the infotainment system and steering wheel controls. It may also limit access to vehicle storage locations (if equipped).

To enable valet mode:

1. Enter a four-digit code on the keypad.
2. Select Enter to go to the confirmation screen.
3. Re-enter the four-digit code.

Press LOCK or UNLOCK to lock or unlock the system. Press Back to go back to the previous menu.

Radio

Press to display the Radio Menu and the following may be displayed:

- Manage Favourites
- Number of Favourites Shown
- Audible Touch Feedback
- Bose AudioPilot

- Maximum Start Up Volume

Manage Favourites

This allows favourites to be edited. See “Manage Favourites” in “Settings” under “Radio” in the infotainment manual.

Number of Favourites Shown

Press to set the number of favourites to display.

Select the desired number or select Auto and the infotainment system will automatically adjust the number of favourites shown.

Audible Touch Feedback

This allows Audible Touch Feedback to be turned on or off.

Select Off or On.

Bose AudioPilot

This feature adjusts the volume based on the noise in the vehicle. See “Bose AudioPilot Noise Compensation Technology” under “Infotainment System Settings” in the infotainment manual.

Maximum Start Up Volume

This feature sets the maximum startup volume. If the vehicle is started and the volume is greater than this level, the volume is adjusted to this level. To set the maximum startup volume, press + or - to increase or decrease.

Vehicle

Select and the following may be displayed:

- Climate and Air Quality
- Comfort and Convenience
- Lighting
- Power Door Locks
- Remote Lock, Unlock, Start

Climate and Air Quality

Select and the following may be displayed:

- Auto Fan Max Speed
- Auto Demist

Auto Fan Max Speed

This feature will set the maximum auto fan speed.

Select Low, Medium, or High.

Auto Demist

When set to On, the front demist will automatically react to temperature and humidity conditions that may cause fogging.

Select Off or On.

Comfort and Convenience

Select and the following may be displayed:

- Auto Memory Recall
- Easy Exit Options
- Chime Volume
- Reverse Tilt Mirror

Auto Memory Recall

This feature automatically recalls the current driver's previously stored 1 or 2 button positions when entering the vehicle. See *Memory Seats* ⇨ 54.

Select Off or On.

Easy Exit Options

This feature automatically recalls the current driver's previously stored Exit button position when exiting the vehicle. See *Memory Seats* ⇨ 54.

Select Off or On.

Chime Volume

This allows the selection of the chime volume level.

Press + or – to adjust the volume.

Reverse Tilt Mirror

This allows the feature to be turned on or off.

Select Off, On - Driver and Passenger, On - Driver, or On - Passenger.

Lighting

Select and the following may be displayed:

- Vehicle Locator Lights
- Exit Lighting

Vehicle Locator Lights

This feature will flash the exterior lamps and allows some of the exterior lamps and most of the interior lamps to turn on briefly when  on the Remote Keyless Entry (RKE) transmitter is pressed to locate the vehicle.

Select Off or On.

Exit Lighting

This allows the selection of how long the exterior lamps stay on when leaving the vehicle when it is dark outside.

Select Off, 30 Seconds, 60 Seconds, or 120 Seconds.

Power Door Locks

Select and the following may be displayed:

- Unlocked Door Anti-Lockout
- Auto Door Lock
- Delayed Door Lock

Unlocked Door Anti-Lockout

When on, this feature will keep the driver door from locking when the door is open. If Off is selected, the Delayed Door Lock menu will be available.

Select Off or On.

Auto Door Lock

When on, the doors will automatically lock when the vehicle exceeds 13 km/h (8 mph).

Select Off or On.

Delayed Door Lock

When on, this feature will delay the locking of the doors. To override the delay, press the power door lock switch on the door.

Select Off or On.

Remote Lock, Unlock, Start

Select and the following may be displayed:

- Remote Unlock Light Feedback
- Remote Lock Feedback
- Remote Door Unlock

- Passive Door Unlock
- Passive Door Lock
- Remote Left in Vehicle Alert

Remote Unlock Light Feedback

When on, the exterior lamps will flash when unlocking the vehicle with the RKE transmitter.

Select Off or On.

Remote Lock Feedback

This allows selection of what type of feedback is given when locking the vehicle with the RKE transmitter.

Select Off, Lights and Horn, Lights Only, or Horn Only.

Remote Door Unlock

This allows selection of which doors will unlock when pressing  on the RKE transmitter.

Select All Doors or Driver Door.

Passive Door Unlock

This allows the selection of what doors will unlock when using the button on the driver door to unlock the vehicle.

Select All Doors or Driver Door.

Passive Door Lock

This feature can be turned on or off, or can be used to select feedback when using the button on the driver door to lock the vehicle. See *Remote Keyless Entry (RKE) System Operation* ⇨ 25.

Select Off, On with Horn Chirp, or On.

Remote Left in Vehicle Alert

This feature sounds an alert when the RKE transmitter is left in the vehicle.

Select Off or On.

Bluetooth

Select and the following may be displayed:

- Pair New Device
- Device Management
- Ringtones
- Voice Mail Numbers

Pair New Device

Select to pair a new device. See “Pairing” in “Infotainment Controls” under “Bluetooth” in the infotainment manual.

Device Management

Select to connect to a different phone source, disconnect a phone, or delete a phone.

Ringtones

Press to change the ring tone for the specific phone. The phone does not need to be connected to change the ring.

Voice Mail Numbers

This feature displays the voice mail number for all connected phones. To change the voice mail number, select EDIT or press the EDIT button. Type a new number, then select SAVE or press the SAVE button.

Voice

Select and the following may be displayed:

- Confidence Threshold

- Prompt Length
- Audio Feedback Speed

Confidence Threshold

This feature allows the adjustment of the sensitivity of the speech recognition system.

Select Confirm More or Confirm Less.

Prompt Length

This feature adjusts the voice prompt length.

Select Short or Long.

Audio Feedback Speed

This feature adjusts the audio feedback speed.

Select Slow, Medium, or Fast.

Display

Select and the following may be displayed:

- Mode
- Calibrate Touchscreen
- Turn Display Off

Mode

Select to change the display screen for day or night driving.

Select Auto, Day, or Night.

Calibrate Touchscreen

Select to calibrate the touchscreen, then follow the prompts.

Turn Display Off

Select to turn the display off. Press anywhere on the display area or any faceplate button to turn the display on.

Rear Camera

Select and the following may be displayed:

- Guidance Lines

Guidance Lines

Select to turn Off or On. See “Guidance Lines” in *Assistance Systems for Parking or Reversing* ⇨ 196.

Return to Factory Settings

Select and the following may be displayed:

- Restore Vehicle Settings
- Clear All Private Data
- Restore Radio Settings

Restore Vehicle Settings

This allows selection of restoring vehicle settings.

Select Cancel or Restore.

Clear All Private Data

This allows selection to clear all private information from the vehicle.

Select Cancel or Delete.

Restore Radio Settings

This allows selection to restore radio settings.

Select Cancel or Restore.

Software Information

Select to view the infotainment system current software information.

Lighting

Exterior Lighting

Exterior Lamp Controls	133
Exterior Lamps Off	
Reminder	133
Headlamp Main/Dipped-Beam	
Changer	134
Flash-to-Pass	134
Daytime Running	
Lamps (DRL)	134
Automatic Headlamp	
System	135
Hazard Lights	136
Turn and Lane-Change	
Signals	136
Rear Fog Lamps	136

Interior Lighting

Instrument Panel Illumination	
Control	137
Courtesy Lamps	137
Reading Lamps	137

Lighting Features

Entry Lighting	138
Exit Lighting	138
Battery Power Protection	138
Exterior Lighting Battery	
Saver	138

Exterior Lighting

Exterior Lamp Controls



The exterior lamp control is on the indicator lever.

There are four positions:

⏻ (**Off**) : Turns off all lamps.

AUTO (Automatic) : Sets the exterior lamps to automatic mode. AUTO mode turns the exterior lamps on and off depending on how much light is available outside the vehicle.

To override AUTO mode, turn the control to off.

To reset to AUTO mode turn the control to exterior lamps and then back to AUTO. Automatic mode also resets when the vehicle is turned off and then back on again if the control is left in the AUTO position.

🚗 (**Parking Lamps**) : Turns on the parking lamps including all lamps, except the headlamps.

The handbrake indicator light comes on and stays on when the parking lamps are on with the engine off and the ignition in ACC/ACCESSORY.

🚗 (**Headlamps**) : Turns on the headlamps together with the parking lamps and instrument panel lights.

Exterior Lamps Off Reminder

A warning chime will sound if the exterior lamp control is left on in either the headlight or parking light position and the driver door is opened with the ignition off.

Headlamp Main/ Dipped-Beam Changer

Push the indicator lever away from you and release to turn the main beams on. To return to dipped beams, push the stalk again or pull it toward you and release.



This indicator light turns on in the instrument cluster when the high-beam headlamps are on.

Flash-to-Pass

To use the flash-to-pass feature, briefly pull the turn signal lever toward you. The main-beam indicator flashes to indicate to the other driver that you intend to pass.

Daytime Running Lamps (DRL)

DRL can make it easier for others to see the front of your vehicle during the day.

The DRL system makes the dedicated lamps come on when the following conditions are met:

- It is still daylight and the ignition is on.
- The exterior lamp control is in the AUTO position.
- The handbrake is off.

When DRL are on, only the front lamps will be on. The parking lamps, tail lamps, instrument panel lights, or other exterior lamps will not be on when the DRL are being used.

When it is dark enough outside, the front lamps dim to parking lamps and the normal dipped beam headlamps turn on.

When it is bright enough outside, the regular lamps go off, and the front DRL lamps will take over. If the vehicle is started in a dark garage,

the automatic headlamp system comes on immediately. Once the vehicle leaves the garage, it takes approximately one minute for the automatic headlamp system to change to DRL if it is light outside. During that delay, the instrument cluster may not be as bright as usual. Make sure the instrument panel brightness knob is in the full bright position. See *Instrument Panel Illumination Control* ⇨ 137.

If it is dark enough outside and the exterior lamp control is off, a Driver Information Centre (DIC) message may display. See *Lamp Messages* ⇨ 121.

Turning the exterior lamp control to off a second time, or turning on the headlamps will remove the DIC message. If the parking lamps were turned on instead, the DIC message will continue to be displayed.

The regular headlamp system should be turned on when needed.

Automatic Headlamp System

When the exterior lamp control is set to AUTO and it is dark enough outside, the headlamps and parking lamps come on automatically.



There is a light sensor on top of the instrument panel. Do not cover the sensor; otherwise the headlamps will come on when they are not needed.

The system may also turn on the headlamps and parking lamps when driving through a parking garage or tunnel.

If the vehicle is started in a dark garage, the automatic headlamp system comes on immediately. If it

is light outside when the vehicle leaves the garage, there is a slight delay before the automatic headlight system changes to the DRL. During that delay, the instrument cluster may not be as bright as usual. Make sure the instrument panel brightness control is in the full bright position. See *Instrument Panel Illumination Control* ⇨ 137.

When it is bright enough outside, the headlamps and parking lamps will turn off or may change to Daytime Running Lamps (DRL).

The automatic headlamp system turns off when the exterior lamp control is turned to  or the ignition is off.



To turn automatic headlamp system back on, turn the band to  again, then release it.

If the automatic headlamp system has the headlamps turned on and you turn the ignition off, the headlamps will turn off. When the driver door is opened the headlamps and parking lamps will illuminate for a period of time.

The length of the delayed illumination period can be changed. See "Exit Lighting" under *Vehicle Personalisation* ⇨ 127.

The regular headlamp system should be turned on when needed.

Lights On with Wipers

If the windscreen wipers are activated in daylight with the engine on and the exterior lamp control is in AUTO, the headlamps, parking lamps, and other exterior lamps will come on. The time it takes for the lamps to turn on depends on the wiper speed. When the wipers are turned off, the lamps turn off. To disable, move the exterior lamp control to  or .

Hazard Lights

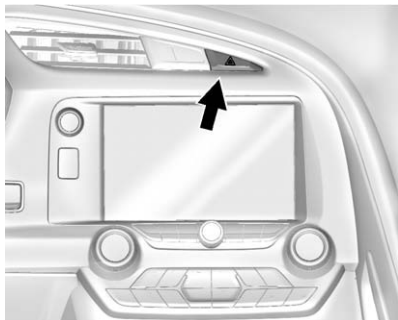

The hazard warning flashers warn others that you have a problem. The button is near the centre of the instrument panel.

▲ (Hazard Warning Indicators) :
Press to make the front and rear turn signal lamps flash on and off. Press again to turn the flashers off.

The hazard warning flashers work no matter what mode the ignition is in, even if the ignition is turned off.

When the hazard warning flashers are on, the turn signals will not work.

Turn and Lane-Change Signals

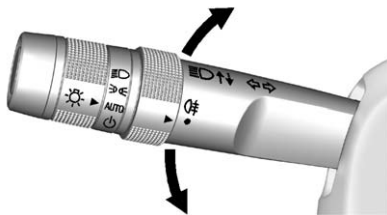

Move the lever all the way up or down to signal a turn.

An arrow on the instrument cluster flashes in the direction of the turn or lane change.

Raise or lower the lever until the arrow starts to flash to signal a lane change. Release the lever and the turn signal automatically flashes three times. If more flashes are desired, continue to hold the lever.

The stalk returns to its starting position when it is released.

If after signalling a turn or lane change the arrows flash rapidly or do not come on, a turn LED may be out.

If a turn LED is out, see your dealer.

Turn Signal on Chime

A chime sounds if the indicator has been on for more than 1.2 km (0.75 mi) of driving.

If you need to leave the indicator on for more than 1.2 km (0.75 mi), turn off the indicator and then turn it back on.

Rear Fog Lamps

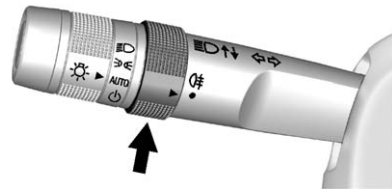

Turn the band to  and release it to turn the rear fog lamps on and off.

When the fog lamps are on, the fog lamp light on the instrument cluster will also be on.

Do not use the fog lamps when visibility is good because it may bother other drivers. It is also not recommended that rear fog lamps be used in city driving. Rear fog lamps should only be used in foggy or misty conditions to allow the drivers behind you to see your vehicle.

Interior Lighting

Instrument Panel Illumination Control



The knob for this feature is on the left side of the instrument panel.

Turn the knob clockwise or anti-clockwise to brighten or dim the instrument panel lights at night. Turn the knob completely clockwise to turn on the interior lights.

Courtesy Lamps

When any door or the hatch/trunk is opened, the interior lamps will come on.

The rear compartment lights only come on when the rear compartment is opened.

To turn the courtesy lamps on or off, turn the instrument panel brightness knob completely clockwise or anti-clockwise.



Reading Lamps



The reading lamps are in the overhead console. The lamps go on when a door is opened. When the doors are closed, press the lamp buttons to turn on each lamp.

Lighting Features

Entry Lighting

Some exterior lamps and most of the interior lamps turn on briefly at night, or in areas with limited lighting, when  is pressed on the Remote Keyless Entry (RKE) transmitter. When the driver door is opened, all control lights, Driver Information Centre (DIC) lights, and door pocket lights turn on. After about 30 seconds the exterior lamps turn off, and then the dome and remaining interior lamps dim to off. Entry lighting can be disabled manually by changing the ignition out of the OFF position, or by pressing  on the RKE transmitter.

This feature can be changed. See “Vehicle Locator Lights” under *Vehicle Personalisation* ⇨ 127.

Exit Lighting

Some exterior lamps come on when the driver door is opened after the ignition is changed to the OFF position and the indicator lever is

pulled briefly toward you and released. The dome lamp comes on after the ignition is changed to the OFF position. The exterior lamps and dome lamp remain on after the door is closed for a set amount of time, then automatically turn off.

The exterior lamps turn off immediately by turning the exterior lamp control off.

This feature can be changed. See *Vehicle Personalisation* ⇨ 127.

Battery Power Protection

This vehicle has a feature to help prevent the battery from being drained in case any of the following lamps are left on: vanity mirror lamps, cargo lamps, reading lamps, or glove box lamps. If any of these lamps are left on, they will automatically time-out after about 10 minutes. To reset it, the ignition must be turned on.

Exterior Lighting Battery Saver

The exterior lamps turn off about 10 minutes after the ignition is turned off, if the parking lamps or headlamps have been manually left on. This protects against draining the battery. To restart the 10-minute timer, turn the exterior lamp control to the off position and then back to the parking lamp or headlamp position.

To keep the lamps on for more than 10 minutes, the ignition must be in the ACC/ACCESSORY or ON/RUN position.

Infotainment System

Introduction

Infotainment 139

Performance Data Recorder (PDR)

Performance Data Recorder (PDR) 139

Introduction

Infotainment

See the infotainment manual for information on the radio, audio players, phone, and navigation system. It also includes information on settings.

Performance Data Recorder (PDR)

If equipped, the PDR icon displays on the Home screen.

Important Information

Read before using the PDR. All or some of the information may apply to your country:

- Use of the Performance Data Recorder (PDR System) may be prohibited or legally restricted in certain countries and situations. It is your own responsibility to ensure compliance with applicable laws and regulations, including but not limited to privacy laws, laws related to camera surveillance and recordings, road traffic and security laws, and laws on the protection of publicity and personality rights.
- You are solely liable for operation of your vehicle and use of the PDR System, including all related legal responsibilities. Vehicles

equipped with the PDR System are intended for use on private tracks only and may under local laws and regulations be restricted or completely excluded from use in areas accessible by the public, such as public roads. You may need a permit, license, or other approval from local authorities in order to comply with applicable laws and regulations.

- Do not use the PDR System if this could distract your attention from traffic or entail other risks.
- Do not rely exclusively on camera footage for steering the vehicle.
- Comply with any notice and consent requirements before capturing and/or recording the voices or images of other persons or collecting other personal data with the PDR System.
- Notify other drivers of your vehicle of the above rules and require them to comply with them.

- General Motors does not accept any responsibility or liability in connection with an impermissible use of the PDR System.
- Please note that law enforcement authorities may have the right to seize video recordings and use them as evidence of criminal/driving offences against you or third parties.
- The PDR System captures and records any sound perceivable within the vehicle, including any conversations among vehicle occupants. Hidden recording of conversations may be an offence under certain jurisdictions. Therefore, all vehicle users and occupants must be informed about ongoing audio recording upon activation of the PDR System.

The PDR records video, audio, and vehicle data. This data is stored on a removable SD card in the glovebox.

The recorded data is not stored anywhere else and is only accessible from the SD card.

To begin, insert a FAT32 formatted SD card, Class 10 required, 8, 16, or 32 GB recommended, into the glove box SD card reader.

Press the PDR icon to access the PDR menu. The options displayed are:

Start Recording

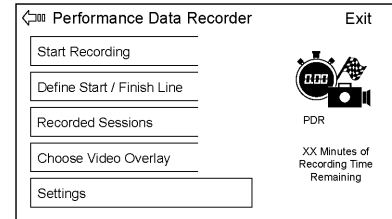

If the system is unable to begin recording, the Start Recording button is greyed out.

Press the Start Recording button to begin recording. After recording begins, this button changes to Stop Recording. Press to stop the recording session.

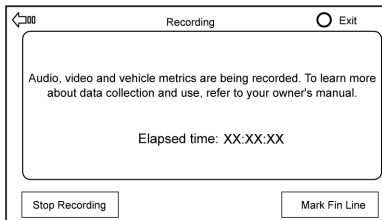

The elapsed time will show when recording. To define a finish line, see “Define Finish Line” later in this section.

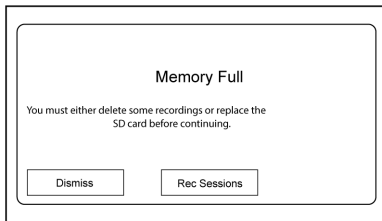

If there is no available space on the SD card, a message displays. Delete or transfer recordings on the SD card or use another SD card with free space.

To delete a recording, go to the Recorded Sessions menu and press **X** next to the item. See “Recorded Sessions” later in this section.

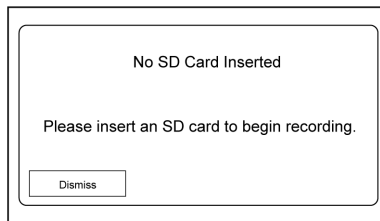

If no SD card is inserted, a message displays.

Define Finish Line

To track and record the vehicle's lap times, the starting point of a lap must be set. Crossing this point activates the lap timer when recording.

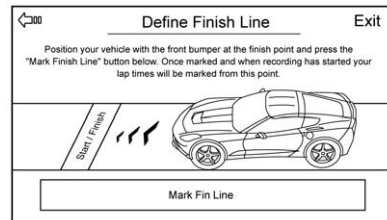

To set the finish line, position the vehicle with the front bumper at the start/finish point. From the PDR menu, press Define Finish Line and then press Mark Fin Line. This can be done with the vehicle moving.

Recorded Sessions

To view recorded videos, press Recorded Sessions.

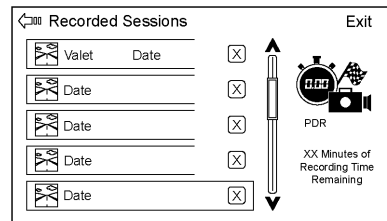

A list of recordings displays.

Select the recording to start playback.

Press **X** next to an item to delete that recording. Press Yes to delete or No to cancel on the confirmation screen. Press Dismiss to exit.

Video playback is not allowed while the vehicle is in motion.

Tap on the screen while the video is playing to display the video controls:

Video Scrubber : Changes the position and playback. The length of the bar corresponds to the time of the video. Advance or rewind the video by dragging along the bar.

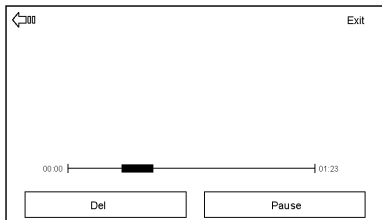

Delete Recording : Press to delete the video. A confirmation screen displays. Press Yes to delete or No to cancel.

Pause/Play : Press to play or pause the video. The button will change when pressed.

Back : Press to display the previous screen.

Exit : Press to exit the current display.

Choose Video Overlay

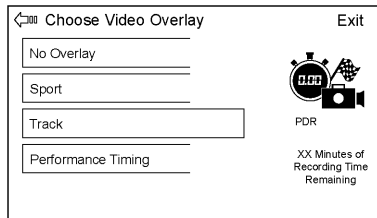

Press the Choose Video Overlay screen button to display the menu screen.

Select one:

- No Overlay
- Sport

- Track
- Performance Timing

No Overlay:

No vehicle data displays on top of the recorded video. Vehicle data is still available with the video when accessed in the toolbox software.

Sport:

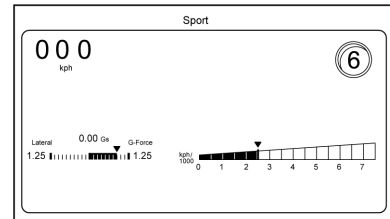

Displays these vehicle metrics:

- **Vehicle Speed:** Up to three digits are displayed in km/h or MPH depending on vehicle settings.
- **Engine Rotations Per Minute (RPMs):** The vertical line and triangle show current RPMs. As the RPMs increase, the orange backfill follows.

- **Transmission State (Current Gear):** Automatic transmissions display PRDN. D can change to D1, D2, etc. When an automatic transmission is in manual shift mode, the display will change to M1, M2, etc. Manual transmissions display 1, 2, etc.
- **Lateral G-Force Graphic:** Left and Right G-Forces are displayed. The graphic fills to the left or the right depending on the measure value. The measured G-Force displays as a number at the top of the graphic.

Track:

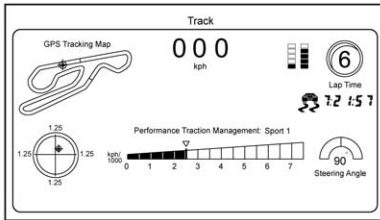

Displays these vehicle metrics:

- **Vehicle Speed:** Same as Sport.

- **GPS Tracking Map:** Shows the vehicle's current position relative to a known route.
- **Engine Rotations Per Minute (RPMs):** The vertical line and triangle indicate current RPMs. As the RPMs increase, the orange backfill follows.
- **Transmission State (Current Gear):** Same as Sport.
- **Friction Bubble Graphic:** Lateral and longitudinal G-Forces are displayed as a dot within a bubble. A red dot displays when the vehicle starts braking and turns green when the vehicle accelerates. The dot is white when the vehicle is not moving. A white dot is the default.

- **Brake and Throttle Graphic:** Displays the percentage value of brake and throttle pedal position from 0–100%.
- **Steering Angle:** The graphic fills from the centre to the left or right depending on the direction of

steering. The numerical steering angle displays below the graphic.

- **Active Handling Active Indicator:** The graphic only displays if the active handling systems are activated.
- **Performance Traction Management (PTM) Mode:** Displays the current PTM mode. The options are Wet, Dry, Sport 1, Sport 2, or Race.
- **Current Lap Time:** Displays the elapsed lap time if the finish line is defined and the vehicle has crossed the defined finish line at least once.

Performance Timing:

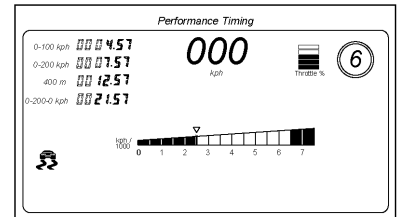

Displays these vehicle metrics:

- Vehicle Speed: Same as Sport.
- Engine Rotations Per Minute (RPMs): Same as Sport.
- Transmission State (Current Gear): Same as Sport.
- 0–100 km/h (0–60 mph), 0–200 km/h (0–100 mph), 400 m (1/4 th mi), and 0–200–0 km/h (0–100–0 mph): The timer starts recording as soon as the vehicle accelerates. As the vehicle passes each speed and distance milestone, it is displayed on the overlay.
- Throttle Position: Displays the percentage of throttle applied from 0–100%.
- Active Handling Active Indicator: The graphic only displays if the active handling systems are activated.

Naming Convention

The recorded video file name is stored as the recorded date and the length of the recording.

If the recorded session was recorded while the system was in Valet Mode, the file name will display the mode, date, and length of time.

Settings

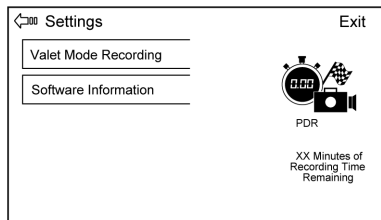

Press the Settings button from the PDR menu to display settings.

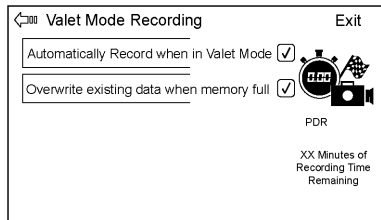

Valet Mode Recording : Allows recording preferences to be selected. It is recommended that a blank SD card be used. Available choices are:

- Automatically record when in Valet Mode: Enables the PDR to begin recording as soon as the vehicle is in Valet Mode.
- Overwrite existing data when memory full: Allows manual overwriting of previous recordings, one at a time starting with the oldest, when the current recording requires additional storage to continue.

Valet mode does not record audio.

Software Information : Displays PDR software information and version numbers.

Toolbox Software : Allows for the evaluation of driver and vehicle performance during a recorded event. See www.Corvette.com to download the software.

Climate Controls

Climate Control Systems

Dual Automatic Climate Control System 145

Air Vents

Air Vents 148

Maintenance

Passenger Compartment Air Filter 149

Climate Control Systems

Dual Automatic Climate Control System

The heating, cooling, and ventilation for the vehicle can be controlled with this system.

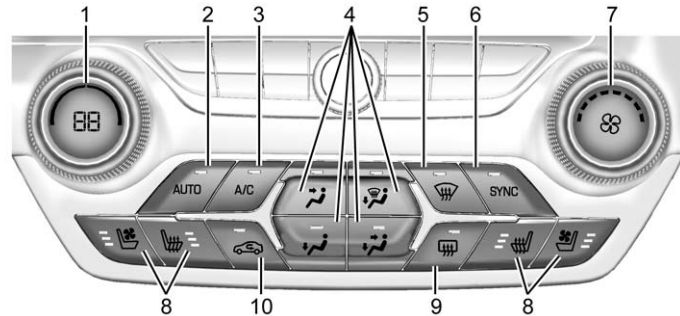

- | | |
|---|---|
| <ol style="list-style-type: none"> 1. Driver Temperature Control 2. AUTO (Automatic Operation) 3. A/C (Air Conditioning) 4. Air Delivery Modes 5. Defrost 6. SYNC 7. Fan Control | <ol style="list-style-type: none"> 8. Driver and Passenger Redundant Heated and Ventilated Front Seat Controls 9. Rear Window Demister 10. Recirculation |
|---|---|



Passenger Temperature Control

The passenger temperature control is below the passenger side air vent.

On/Off System Operation

Press AUTO to turn the system on. Turn the fan control knob completely anti-clockwise to turn the fan off.

Automatic Operation

The system automatically controls the fan speed, air delivery, air conditioning, and recirculation in order to heat or cool the vehicle to the desired temperature.

When the AUTO indicator light is on, the system is in full automatic operation. If the air delivery mode or fan setting is manually adjusted or the A/C is turned off, the AUTO indicator turns off and displays will show the selected settings.

To place the system in automatic mode:

1. Press AUTO.
2. Set the temperature. Allow the system time to stabilise. Then adjust the temperature as needed for best comfort.

The system operates to reach the set temperature as quickly as possible. The AUTO control system works best with the windows up and the removable roof panel installed or the convertible top up.

Manual Operation





Driver and Passenger Temperature Control : The temperature can be adjusted separately for the driver and passenger.

Turn the knob clockwise or anti-clockwise to increase or decrease the driver temperature setting. Press Δ or ∇ to increase or decrease the passenger temperature setting.

SYNC : Press to link all climate zone settings to the driver settings. The SYNC indicator light will turn on. When the passenger temperature setting is adjusted, the SYNC indicator light turns off.

Fan Control : Turn the knob clockwise or anticlockwise to increase or decrease the fan speed. Turn the knob completely anti-clockwise to turn the fan off.

Press AUTO to return to automatic operation.

Air Delivery Modes : Press , , , or  to change the direction of the airflow. An indicator light comes on in the selected mode button.

Changing the mode cancels the automatic operation and the system goes into manual mode. Press AUTO to return to automatic operation.

 **(Vent)** : Air is directed to the instrument panel outlets.

 **(Floor)** : Air is directed to the floor outlets.

 **(Bi-Level)** : Air is directed to the instrument panel outlets and the floor outlets.

 **(Demist)** : Air is directed to the windscreen and floor outlets to clear the windows of mist or moisture. The recirculation mode cannot be selected while in the demist mode.

 **(Defrost)** : Press to clear the windscreen of mist or frost more quickly. Air is directed to the windshield and side window outlets. The recirculation mode cannot be selected while in defrost mode.

For best results, clear all snow and ice from the windscreen before defrosting.

Do not drive the vehicle until all the windows are clear.

A/C (Air Conditioning) : Press to turn the air conditioning on or off. If the fan is turned off, the air conditioner will not run and the indicator light may turn off.

Press AUTO to return to automatic operation and the air conditioner runs as needed. When the indicator light is on, the air conditioner runs automatically to cool the air inside the vehicle or to dry the air as needed to demist the windscreen faster.

Depending on the engine speed, the air conditioning compressor may shut off and turn on again and a slight change in A/C cooling and engine performance may be noticed. This is normal. The system is designed to make adjustments to help with fuel economy while still maintaining the selected temperature.

If the A/C is turned off, automatic operation is cancelled.

 **(Recirculation)** : Press to turn on recirculation. An indicator light comes on. Air is recirculated to quickly cool the inside of the vehicle

or reduce the entry of outside air and odours. Recirculation mode is not available in defrost or defog mode.

Rear Window Demister

 **(Rear Window Demister)** : Press to turn the rear window demister on or off. An indicator light on the button comes on to show that the rear window demister is on.



The demister only works when the ignition is in ON/RUN. The demister turns off if the ignition is in the ACC/ACCESSORY or LOCK/OFF position.

If equipped with heated outside rearview mirrors, they turn on with the rear window demister and help to clear fog or frost from the surface of the mirror. See *Heated Mirrors* ⇨ 40.

If equipped with a power convertible top, the rear window demister and heated mirrors are automatically disabled when the power convertible top is moving or down.

Caution

Using a razor blade or sharp object on the inside rear window can damage the aerial or demister. Repairs would not be covered by the vehicle warranty. Do not stick anything to the rear window.

  **(Driver and Passenger Heated and Ventilated Seats, If Equipped)** : Press to heat or ventilate the seat. See *Heated and Ventilated Front Seats* ⇨ 56.

Sensors

The interior cabin air temperature and solar sensor on top of the instrument panel near the windshield monitors the solar heat and measures the initial interior cabin temperature.

The climate control system uses the sensor information to adjust the temperature, fan speed, recirculation, and air delivery mode for best comfort.

The humidity and windscreen temperature sensor is on the windscreen glass inside surface near the rearview mirror. The automatic climate control system uses this sensor to receive information to determine the need for demisting.

If any of these sensors are blocked or covered, the automatic climate control system may not work properly.

There is also a sensor behind the front bumper. This sensor reads the outside air temperature and helps to maintain the temperature inside the vehicle. Any cover on the front of the vehicle could give a false reading in the temperature.

Air Vents

Use the tab on the air outlets to change the direction of the airflow.

Operation Tips

- Clear away any ice, snow, or leaves from the air inlets at the base of the windshield that may block the flow of air into the vehicle.
- Use of non-GM approved hood deflectors may adversely affect the performance of the system.
- Keep the area around the base of the instrument panel console and air path under the seats clear of objects to help circulate the air inside of the vehicle more effectively.

Maintenance

Passenger Compartment Air Filter

The passenger compartment air filter removes certain particles from the air including pollen and dust particles. Reductions in airflow, which may occur more often in dusty areas, indicate that the filter may need to be replaced. See *Scheduled Maintenance* ⇨ 283.

Caution

Driving without a passenger compartment air filter in place can cause water and small particles, like paper and leaves, to be pulled into your climate control system which may cause damage to it. Make sure you always replace the old filter with a new one.

The passenger compartment air filter is on the passenger side of the engine compartment near the coolant surge tank. See *Engine Compartment Overview* ⇨ 208.

To check or replace the air filter:

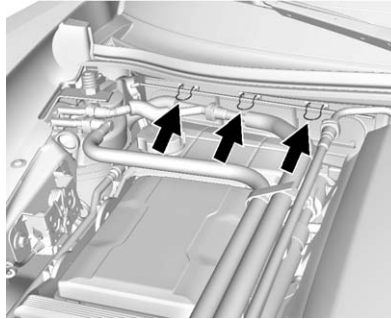

1. Release the retainer clips from the passenger compartment air filter cover. The PVC hoses may need to be held out of the way briefly to access the air filter cover.
2. Remove the cover.

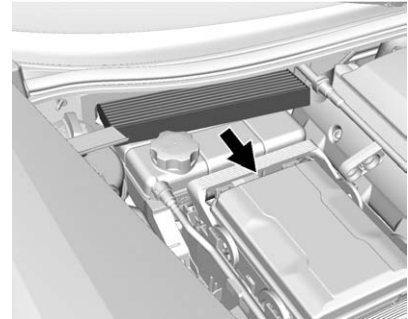

3. Remove the filter and install the new air filter.
4. Replace the filter cover.
5. Attach the retainer clips.

Driving and Operating

Driving Information

Distracted Driving	151
Defensive Driving	151
Control of a Vehicle	151
Braking	152
Steering	152
Off-Road Recovery	153
Loss of Control	153
Track Events and Competitive Driving	154
Driving on Wet Roads	159
Hill and Mountain Roads	160
Winter Driving	161
If the Vehicle Is Stuck	162
Vehicle Load Limits	162

Starting and Operating

New Vehicle Run-In	166
Front Air Dam	167
Carbon Fibre	167
Ignition Positions	167
Starting the Engine	169
Retained Accessory Power (RAP)	171
Shifting Into Park	171
Shifting out of Park	172

Parking	172
Parking over Things That Burn	173
Active Fuel Management®	173

Engine Exhaust

Engine Exhaust	174
Running the Vehicle While Parked	174

Automatic Transmission

Automatic Transmission	175
Manual Mode	176

Manual Gearbox

Manual Gearbox	179
Active Rev Match	181

Brakes

Antilock Brake System (ABS)	182
Electric Parking Brake	182
Brake Assist	184
Hill Start Assist (HSA)	184

Ride Control Systems

Traction Control/Electronic Stability Control	185
Driver Mode Control	187
Competitive Driving Mode	190
Limited-Slip Differential	193

Cruise Control

Cruise Control	193
----------------------	-----

Driver Assistance Systems

Assistance Systems for Parking or Reversing	196
---	-----

Fuel

Fuel	197
Fuel Additives	198
Filling the Tank	198
Filling a Portable Fuel Container	200

Trailer Towing

General Towing Information	201
----------------------------------	-----

Conversions and Add-Ons

Add-On Electrical Equipment	201
-----------------------------------	-----

Driving Information

Distracted Driving

Distraction comes in many forms and can take your focus from the task of driving. Exercise good judgement and do not let other activities divert your attention away from the road. Many local governments have enacted laws regarding driver distraction. Become familiar with the local laws in your area.

To avoid distracted driving, always keep your eyes on the road, hands on the wheel, and mind on the drive.

- Do not use a phone in demanding driving situations. Use a hands-free method to place or receive necessary phone calls.
- Watch the road. Do not read, take notes, or look up information on phones or other electronic devices.
- Designate a front seat passenger to handle potential distractions.

- Become familiar with vehicle features before driving, such as programming favourite radio stations and adjusting climate control and seat settings. Program all trip information into any navigation device prior to driving.
- Wait until the vehicle is parked to retrieve items that have fallen to the floor.
- Stop or park the vehicle to tend to children.
- Keep pets in an appropriate carrier or restraint.
- Avoid stressful conversations while driving, whether with a passenger or on a mobile phone.

Warning

Taking your eyes off the road too long or too often could cause a crash resulting in injury or death. Focus your attention on driving.

Refer to the infotainment manual for more information on using that system and the navigation system, if equipped, including pairing and using a mobile phone.

Defensive Driving

Defensive driving means “always expect the unexpected.” The first step in driving defensively is to wear the safety belt. See *Safety Belts* ⇨ 58.

- Assume that other road users (pedestrians, bicyclists, and other drivers) are going to be careless and make mistakes. Anticipate what they might do and be ready.
- Allow enough following distance between you and the driver in front of you.
- Focus on the task of driving.

Control of a Vehicle

Braking, steering, and accelerating are important factors in helping to control a vehicle while driving.

Braking

Braking action involves perception time and reaction time. Deciding to push the brake pedal is perception time. Actually doing it is reaction time.

Average driver reaction time is about three-quarters of a second. In that time, a vehicle moving at 100 km/h (60 mph) travels 20 m (66 ft), which could be a lot of distance in an emergency.

Helpful braking tips to keep in mind include:

- Keep enough distance between you and the vehicle in front of you.
- Avoid needless heavy braking.
- Keep pace with traffic.

If the engine ever stops while the vehicle is being driven, brake normally but do not pump the brakes. Doing so could make the pedal harder to push down. If the engine stops, there will be some power brake assist but it will be used when the brake is applied.

Once the power assist is used up, it can take longer to stop and the brake pedal will be harder to push.

Steering

Electric Power Steering

The vehicle has electric power steering. It does not have power steering fluid. Regular maintenance is not required.

If power steering assist is lost due to a system malfunction, the vehicle can be steered, but may require increased effort.

See your dealer if there is a problem.

If the steering wheel is turned until it reaches the end of its travel and is held against that position for an extended period of time, power steering assist may be reduced.

If the steering assistance is used for an extended period of time, power assistance may be reduced.

Normal use of the power steering assist should return when the system cools down.

See specific vehicle steering messages under *Service Vehicle Messages* ⇨ 124. See your dealer if there is a problem.

Bend Tips

- Take bends at a reasonable speed.
- Reduce speed before entering a bend.
- Maintain a reasonable steady speed through the bend.
- Wait until the vehicle is out of the bend before accelerating gently into the straight.

Steering in Emergencies

- There are some situations when steering around a problem may be more effective than braking.
- Holding both sides of the steering wheel allows you to turn 180 degrees without removing a hand.
- The Antilock Brake System (ABS) allows steering while braking.

Off-Road Recovery

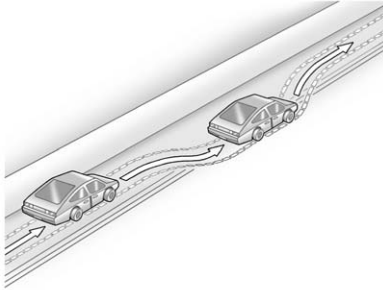

The vehicle's right wheels can drop off the edge of a road onto the shoulder while driving. Follow these tips:

1. Ease off the accelerator and then, if there is nothing in the way, steer the vehicle so that it straddles the edge of the pavement.
2. Turn the steering wheel about one-eighth of a turn, until the right front tyre contacts the pavement edge.

3. Turn the steering wheel to go straight down the roadway.

Loss of Control

Skidding

There are three types of skids that correspond to the vehicle's three control systems:

- Braking Skid - wheels are not rolling.
- Steering or Cornering Skid - too much speed or steering in a bend causes tyres to slip and lose cornering force.
- Acceleration Skid - too much throttle causes the driving wheels to spin.

Defensive drivers avoid most skids by taking reasonable care suited to existing conditions, and by not overdriving those conditions. But skids are always possible.

If the vehicle starts to slide, follow these suggestions:

- Ease your foot off the accelerator pedal and steer the way you want the vehicle to go.

The vehicle may straighten out. Be ready for a second skid if it occurs.

- Slow down and adjust your driving according to weather conditions. Stopping distance can be longer and vehicle control can be affected when traction is reduced by water, snow, ice, gravel, or other material on the road. Learn to recognise warning clues - such as enough water, ice, or packed snow on the road to make a mirrored surface - and slow down when you have any doubt.
- Try to avoid sudden steering, acceleration, or braking, including reducing vehicle speed by shifting to a lower gear. Any sudden changes could cause the tyres to slide.

Remember: Antilock brakes help avoid only the braking skid.

Track Events and Competitive Driving

Participating in track events or other competitive driving without following the instructions provided may affect the vehicle warranty. See the warranty manual before using the vehicle for racing or other competitive driving.

Refer to *Competitive Driving Mode* ⇨ 190.

Be sure to follow all service procedures before driving the vehicle at track events or competitively.

Engine Sound Management Setting

Caution

Do not place vehicle in Engine Sound Management – Stealth mode. Damage could result to exhaust valve actuators.

Engine Oil

Caution

If the vehicle is used for track events and competitive driving, the engine may use more oil than it would with normal use. Low oil levels can damage the engine. Check the oil level often and maintain the proper level. See *Engine Oil* ⇨ 211.

Caution

Not changing the engine oil to 15W-50 may cause engine damage. Engine oil must be changed to 15W-50 synthetic. See *Capacities and Specifications* ⇨ 291.

Z51 Performance Package and Z06 Only: Check the oil level often during track events and competitive driving and keep the level at or near 0.5 L (0.5 qt) above the upper mark that shows the proper operating

range on the engine oil dipstick. After the competitive driving, remove excess oil so that the level on the dipstick is not above the upper mark that shows the proper operating range.

Stingray without Z51 Performance Package: Additional oil fill above the upper mark on the dipstick is not recommended for track events or other competitive driving. Check the oil level often during racing or other competitive driving and keep the level at or near the upper mark that shows the proper operating range on the engine oil dipstick. After the competitive driving, remove excess oil so that the level on the dipstick is not above the upper mark that shows the proper operating range.

After track use, change the oil back to 5W-30 for street use. See *Engine Oil* ⇨ 211.

Brake Fluid

Replace existing brake fluid with a qualified high performance brake fluid from a sealed container. Brake fluid with a dry boiling point >279 °C (534 °F) is qualified. If high

performance brake fluid is used, replace it with GM approved brake fluid before driving on public roads. If high performance brake fluid is in the vehicle and the age of the brake fluid is over a month old or unknown, replace the brake fluid before track events and competitive driving. Do not use silicone or DOT-5 brake fluids.

Load Limit

Z51 Performance Package Only: Limit vehicle load to the driver only, with no other cargo. Inflate tires to 180 kPa (26 psi) and drive at a maximum speed of 280 km/h (174 mph).

Z06 Only: Limit vehicle load to the driver only, with no other cargo. Inflate tires to 180 kPa (26 psi) and drive at a maximum speed of 296 km/h (184 mph).

Wheel Alignment

Caution

Using these wheel alignment settings may cause excessive tyre wear. Only use these wheel alignment settings for racing or competitive driving. Excessive tyre wear is not covered under the vehicle warranty.

If the vehicle is equipped with the Z51 Performance Package or is a Z06, the racing and competitive driving wheel alignment settings should be set as follows:

Alignment should only be done by adjusting the lower control arm cam bolts and by removing a maximum of one washer between the upper control arms and frame.

Alignment values are targets. See your retailer for tolerances.

Front (per corner)

- Caster: +7.0 degrees
- Camber: -2.0 degrees

- Toe: 0.05 degrees toe in

Rear (per corner)

- Caster: 0 degrees
- Camber: -2.0 degrees
- Toe: 0.05 degrees toe in

Thrust Angle: 0 degrees

Rear Axle Fluid

Caution

During a first time track or racing event, high rear axle temperatures can occur. Damage could be caused to the rear axle and would not be covered by the vehicle warranty. Do not drive as long or as fast the first time the vehicle is driven on the track or raced.

Axles must have 885 km (500 mi) before being used in track driving

The rear axle fluid temperatures may be higher than when driving in severe conditions. Drain and refill with new fluid after the first racing or

competitive driving event, and then after every 24 hours of racing or competitive driving. See *Recommended Fluids and Lubricants* ⇨ 286.

General Information

If reduced performance is experienced during track events or competitive driving, turning off the A/C will help to improve engine performance.

Maintain a mixture of 40% DEX-COOL coolant and 60% clean, drinkable water to optimise engine performance.

The front license plate bracket or aero panel should be removed for track events and competitive driving to improve engine performance.

Rotor Cooling Ring, If Equipped

The following installation procedure is for Z51 Performance Package, and only if the vehicle is equipped with front dual cast brake rotors along with the supplied brake cooling ring kit. See your retailer for information.

If the vehicle has the Z51 Performance Package and equipped with a one piece brake rotor, a cooling ring is not required.

Caution

Do not leave rotor cooling rings installed after a track event, as this can cause corrosion with long-term use. Rotor cooling rings are for track use only. Track driving without the rotor cooling rings may result in brake pedal fade.

Installation:

1. Remove the front wheels.
2. Cut three 150 mm (6 in) lengths of safety wire specified to T304 Stainless Steel, 0.041 in nominal diameter, not included.
3. Form each into a U shape with a 20 mm (0.75 in) flat area in the centre of the wire.

4. Place the rotor ring in the gap between the rotor brake plate and rotor hat, with the holes on each side of the rotor spoke on the outboard side of the rotor.

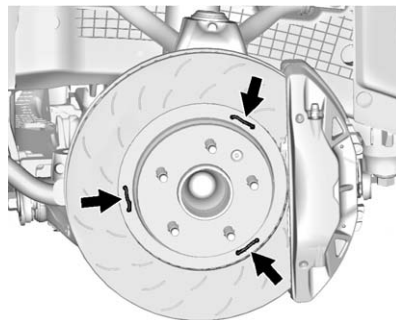

5. Place the U-shaped wire through the holes in the rotor cooling ring.
6. Bring the ends of the wire tight around the corresponding rotor spoke.
7. Twist the safety wire into six to eight twists per 2.54 cm (1 in).

8. Bend the twisted wire so it is flush with the inside of the rotor ring to prevent contact with the calliper or brake hoses.
9. Verify that the rotor rings and safety wire do not contact any other components.
10. Reinstall the wheel using the specific wheel nut torque. See *Capacities and Specifications* ⇨ 291.

If additional brake cooling is required, the grille mesh in the lower corners of the front grille in front of the brake duct can be removed. This is not reversible, and a replacement grille will not be covered by the vehicle warranty. If this is done, it is recommended that the gap between the fascia and the cooling duct be taped over.

Brake Burnishing

New brake pads must be burnished before racing or other competitive driving.

Caution

Performing the brake burnish procedure on a base brake system can result in brake damage.

Caution

The new vehicle break-in period should be completed before performing the brake burnish procedure, otherwise damage may occur to the powertrain/engine. See *New Vehicle Run-In* ⇨ 166.

Caution

Brake pedal fade will occur during any track burnish procedure and can cause brake pedal travel and force to increase. This could extend stopping distance until the brakes are fully burnished.

When this procedure is performed as instructed, it will not damage the brakes. The brake pads will smoke and produce an odour. The braking force and pedal travel may increase. After the procedure, the brake pads may appear white at the rotor contact.

Perform this procedure only on dry pavement, in a safe manner, and in compliance with all local and state ordinances/laws regarding motor vehicle operation.

Brake Burnish Procedure (Z51 Performance Package and Z06 without Z07 Performance Package or Z06 without J57 Ceramic Brakes)

1. Apply the brakes 25 times starting at 100 km/h (60 mph) to 50 km/h (30 mph) while decelerating at 0.4 g. This is a medium brake application. Drive for at least 1 km (0.6 mi) between applying the brakes. This first step may be skipped if there are more than 320 km (200 mi) on the brake pads.

2. Repeatedly apply the brakes from 100 km/h (60 mph) to 25 km/h (15 mph) while decelerating at 0.8 g. This is a hard brake application, without activating the Antilock Brake System (ABS). Drive for at least 1 km (0.6 mi) between stops. Repeat until the brake pedal travel starts to increase. Depending on conditions, this should take no longer than 25 brake applications.
3. Cool down: Drive at 100 km/h (60 mph) for approximately 15 km (10 mi) without using the brakes.
4. Apply the brakes 25 times from 100 km/h (60 mph) to 50 km/h (30 mph) while decelerating at 0.4 g. This is a medium brake application. Drive for at least 1 km (0.6 mi) between applications.

Street High Performance Brake Burnishing Procedure (Z06 with Z07 Performance Package or Z06 with J57 Ceramic Brakes)

1. From a stop, accelerate as rapidly as possible without activating traction control to a speed of 100 km/h (60 mph).
2. Use enough pedal force to completely stop the vehicle in four to five seconds. If ABS activates, braking is too hard.
3. Repeat Steps 1 and 2 – 50 times. This should take about 10 minutes.
4. After completing the 50 stops, cool the brakes by driving for 8 km (5 mi) at 100 km/h (60 mph).

As with all high performance brake systems, some amount of brake squeal is normal.

Racing/Track Brake Burnishing Procedure (Z06 with Z07 Performance Package or Z06 with J57 Ceramic Brakes)

This procedure should only be run on a track and only on dry pavement.

Caution

Brake pedal fade will occur during this track burnish procedure and can cause brake pedal travel and force to increase. This could extend stopping distance until the brakes are fully burnished.

1. Drive a normal first lap, not too aggressively.
2. Laps 2 and 3 should be gradually driven faster and more aggressively, while allowing for reduced brake output and increased stopping distance due to brake fade.

3. Drive Lap 4 near full speed, while allowing for reduced brake output and increased stopping distance due to brake fade.
4. Laps 5 and 6 should be cool down laps.
5. Lap 7 should be normal driving or an easy out lap.

Z07 Performance Package

The Z07 Performance Package has an installed Stage 2 Aero Package, which consists of a front splitter with short end caps, rocker panel extensions, and a rear spoiler.

Stage 3 Aero components are delivered but not installed on the vehicle. These are intended to be installed for track use only. The components include:

- Front splitter tall end caps that replace the front splitter short end caps.
- A center transparent wicker bill for the rear spoiler.

Warning

Changing the following track settings could reduce tire traction and could cause a crash. Do not change the track settings.

The track settings for the Z07 Performance Package with the Stage 3 Aero Package are:

- The front splitter tall end caps installed.
- The center transparent wicker bill installed all the way up on the rear spoiler.
- The Driver Mode Selector in Track Mode.

Stingray with Performance Package-Carbon Fiber (CFZ)

The Stingray with Performance Package-Carbon Fiber (CFZ) has an installed aero package which consists of a front splitter with short end caps, rocker panel extensions, and a rear spoiler. A center transparent wicker bill for the rear

spoiler is delivered but not installed. This is intended to be installed for track use only.

Driving on Wet Roads

Rain and wet roads can reduce vehicle traction and affect your ability to stop and accelerate. Always drive slower in these types of driving conditions and avoid driving through large puddles and deep-standing or flowing water.

Warning

Wet brakes can cause crashes. They might not work as well in a quick stop and could cause pulling to one side. You could lose control of the vehicle.

After driving through a large puddle of water or a car/vehicle wash, lightly apply the brake pedal until the brakes work normally.

(Continued)

Warning (Continued)

Flowing or rushing water creates strong forces. Driving through flowing water could cause the vehicle to be carried away. If this happens, you and other vehicle occupants could drown. Do not ignore police warnings and be very cautious about trying to drive through flowing water.

Aquaplaning

Aquaplaning is dangerous. Water can build up under the vehicle's tyres so they actually ride on the water. This can happen if the road is wet enough and you are going fast enough. When the vehicle is aquaplaning, it has little or no contact with the road.

There is no hard and fast rule about aquaplaning. The best advice is to slow down when the road is wet.

Other Rainy Weather Tips

Besides slowing down, other wet weather driving tips include:

- Allow extra following distance.
- Overtake with caution.
- Keep windscreen wiping equipment in good condition.
- Keep the windscreen washer fluid reservoir filled.
- Have good tyres with proper tread depth. See *Tyres* ⇨ 245.
- Turn off cruise control.

Hill and Mountain Roads

Driving on steep hills or through mountains is different than driving on flat or rolling terrain. Tips include:

- Keep the vehicle serviced and in good shape.
- Check all fluid levels and brakes, tyres, cooling system, and transmission.
- Shift to a lower gear when going down steep or long hills.

 **Warning**

Using the brakes to slow the vehicle on a long downhill slope can cause brake overheating, can reduce brake performance, and could result in a loss of braking. Shift the transmission to a lower gear to let the engine assist the brakes on a steep downhill slope.

 **Warning**

Coasting downhill in N (Neutral) or with the ignition off is dangerous. This can cause overheating of the brakes and loss of steering. Always have the engine running and the vehicle in gear.

- Drive at speeds that keep the vehicle in its own lane. Do not swing wide or cross the centre line.

- Be alert on top of hills; something could be in your lane (e.g., stalled car, accident).
- Pay attention to special road signs (e.g., falling rocks area, winding roads, long gradients, overtaking or no-overtaking zones) and take appropriate action.

Winter Driving

Driving on Snow or Ice

Snow or ice between the tyres and the road creates less traction or grip, so drive carefully. Wet ice can occur at about 0 °C (32 °F) when freezing rain begins to fall. Avoid driving on wet ice or in freezing rain until roads can be treated.

For Slippery Road Driving:

- Accelerate gently. Accelerating too quickly causes the wheels to spin and makes the surface under the tyres slick.
- Turn on Traction Control. See *Traction Control/Electronic Stability Control* ⇨ 185.
- Antilock Brake System (ABS) improves vehicle stability during hard stops, but the brakes should be applied sooner than when on dry pavement. See *Antilock Brake System (ABS)* ⇨ 182.
- Allow greater following distance and watch for slippery spots. Icy patches can occur on otherwise clear roads in shaded areas. The surface of a curve or an overpass can remain icy when the surrounding roads are clear. Avoid sudden steering manoeuvres and braking while on ice.
- Turn off cruise control.

Blizzard Conditions

Stay with the vehicle unless there is help nearby. To get help and keep everyone in the vehicle safe:

- Turn on the hazard warning lights.
- Tie a red cloth to an outside mirror.

Warning

Snow can trap engine exhaust under the vehicle. This may cause exhaust gases to get inside. Engine exhaust contains carbon monoxide (CO), which cannot be seen or smelled. It can cause unconsciousness and even death.

If the vehicle is stuck in snow:

- Clear snow from the base of the vehicle, especially any blocking the exhaust pipe.
- Open a window about 5 cm (2 in) on the vehicle side that is away from the wind, to bring in fresh air.
- Fully open the air outlets on or under the instrument panel.
- Adjust the climate control system to circulate the air inside the vehicle and set

(Continued)

Warning (Continued)

the fan speed to the highest setting. See “Climate Control Systems.”

For more information about CO, see *Engine Exhaust* ⇨ 174.

To save fuel, run the engine for short periods to warm the vehicle and then shut the engine off and partially close the window. Moving about to keep warm also helps.

If it takes time for help to arrive, when running the engine, push the accelerator pedal slightly so the engine runs faster than the idle speed. This keeps the battery charged to restart the vehicle and to signal for help with the headlamps. Do this as little as possible, to save fuel.

If the Vehicle Is Stuck

Slowly and cautiously spin the wheels to free the vehicle when stuck in sand, mud, ice, or snow.

If stuck too severely for the traction system to free the vehicle, turn the traction system off and use the rocking method. See *Traction Control/Electronic Stability Control* ⇨ 185.

Warning

If the vehicle's tyres spin at high speed, they can explode, and you or others could be injured. The vehicle can overheat, causing an engine compartment fire or other damage. Spin the wheels as little as possible and avoid going above 56 km/h (35 mph).

Rocking the Vehicle to Get it Out

Turn the steering wheel left and right to clear the area around the front wheels. Turn off any traction system. Shift back and forth between R (Reverse) and a low forward gear, spinning the wheels as little as possible. To prevent transmission wear, wait until the wheels stop spinning before shifting

gears. Release the accelerator pedal while shifting, and press lightly on the accelerator pedal when the transmission is in gear. Slowly spinning the wheels in the forward and reverse directions causes a rocking motion that could free the vehicle. If that does not get the vehicle out after a few tries, it might need to be towed out. If the vehicle does need to be towed out, see *Towing the Vehicle* ⇨ 272.

Vehicle Load Limits

It is very important to know how much weight the vehicle can carry. This weight is called the vehicle capacity weight and includes the weight of all occupants, cargo, and all non-factory-installed options. Two labels on the vehicle may show how much weight it may properly carry: the Tyre and Loading Information label and the Certification label.

Warning

Do not load the vehicle any heavier than the Gross Vehicle Weight Rating (GVWR), or either the maximum front or rear Gross Axle Weight Rating (GAWR). This can cause systems to break and change the way the vehicle handles. This could cause loss of control and a crash. Overloading can also reduce stopping distance, damage the tyres, and shorten the life of the vehicle.

Tyre and Loading Information Label

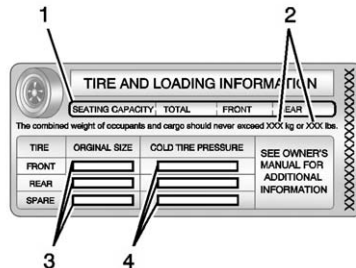

Label Example

A vehicle-specific Tyre and Loading Information label is attached to the centre pillar (B-pillar). This label shows the number of occupant seating positions (1), and the maximum vehicle capacity weight (2) in kilograms and pounds.

The Tyre and Loading Information label also shows the size of the original equipment tyres (3) and the recommended cold tyre inflation pressures (4). For more information on tyres and inflation see *Tyres* ⇨ 245 and *Tyre Pressure* ⇨ 249.

There is also important loading information on the vehicle Certification label. It may show the Gross Vehicle Weight Rating (GVWR) and the Gross Axle Weight Rating (GAWR) for the front and rear axle. See “Certification Label” later in this section.

“Steps for Determining Correct Load Limit–

1. Locate the statement “The combined weight of occupants and cargo should never exceed XXX kg or XXX lbs.” on your vehicle's placard.

2. Determine the combined weight of the driver and passengers that will be riding in your vehicle.
3. Subtract the combined weight of the driver and passengers from XXX kg or XXX lbs.
4. The resulting figure equals the available amount of cargo and luggage load capacity. For example, if the "XXX" amount equals 1400 lbs. and there will be five 150 lb passengers in your vehicle, the amount of available cargo and luggage load capacity is 650 lbs. (1400-750 (5 x 150) = 650 lbs.)
5. Determine the combined weight of luggage and cargo being loaded on the vehicle. That weight may not safely

exceed the available cargo and luggage load capacity calculated in Step 4.

6. If your vehicle will be towing a trailer, load from your trailer, load from your trailer will be transferred to your vehicle. Consult this manual to determine how this reduces the available cargo and luggage load capacity of your vehicle."

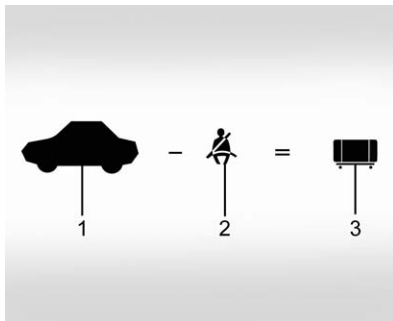

Example 1

1. Vehicle Capacity Weight for Example 1 = 181 kg (400 lbs)

2. Subtract Occupant Weight @ 68 kg (150 lbs) × 1 = 68 kg (150 lbs)
3. Available Occupant and Cargo Weight = 113 kg (250 lbs)

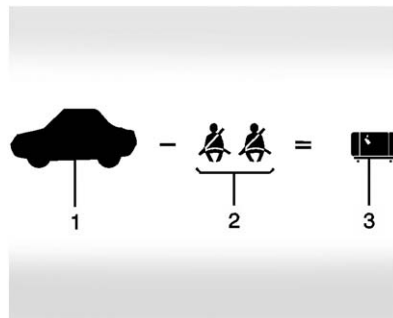

Example 2

1. Vehicle Capacity Weight for Example 2 = 181 kg (400 lbs)
2. Subtract Occupant Weight @ 68 kg (150 lbs) × 2 = 136 kg (300 lbs)
3. Available Cargo Weight = 45 kg (100 lbs)

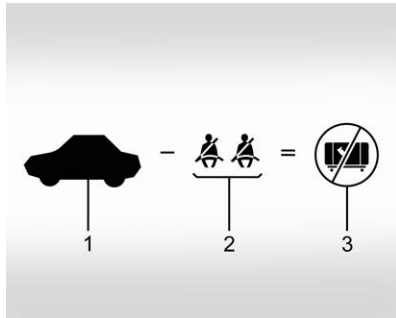

Example 3

1. Vehicle Capacity Weight for Example 3 = 181 kg (400 lbs)
2. Subtract Occupant Weight @ 91 kg (200 lbs) \times 2 = 181 kg (400 lbs)
3. Available Cargo Weight = 0 kg (0 lbs)

Refer to the vehicle's Tyre and Loading Information label for specific information about the vehicle's capacity weight and seating positions. The combined

weight of the driver, passengers and cargo should never exceed the vehicle's capacity weight.

Certification Label

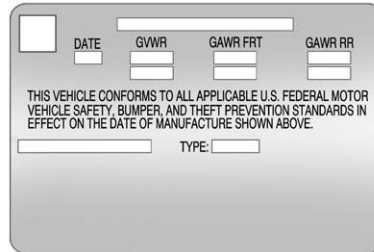

A vehicle-specific Certification label is located on the right side centre pillar (B-pillar). It may show the gross weight capacity of the vehicle, called the Gross Vehicle Weight Rating (GVWR). The GVWR includes the weight of the vehicle, all occupants, fuel and cargo.

Caution

Overloading the vehicle may cause damage. Repairs would not be covered by the vehicle warranty. Do not overload the vehicle.

Warning

Things you put inside your vehicle can strike and injure people in a sudden stop or turn, or in a crash.

- Put things in the rear area of your vehicle. Try to spread the weight evenly.
- Never stack heavier things, like suitcases, inside the vehicle so that some of them are above the tops of the seats.

(Continued)

Warning (Continued)

- Do not leave an unsecured child restraint in your vehicle.
- When you carry something inside the vehicle, secure it whenever you can.

Starting and Operating**New Vehicle Run-In**

Follow these recommended guidelines during the first 2.414 km (1.500 mi) of driving this vehicle. Parts have a running-in period and performance will be better in the long run.

For the first 322 km (200 mi):

- To run-in new tyres, drive at moderate speeds and avoid hard cornering.
- New brake linings also need a running-in period. Avoid braking hard. This is recommended every time brake linings are replaced.

For the first 800 km (500 mi):

- Avoid full throttle starts and abrupt stops.
- Do not exceed 4000 rpm.

- Avoid driving at any one constant speed, fast or slow, including the use of cruise control.
- Avoid downshifting to brake or slow the vehicle when the engine speed will exceed 4000 rpm.
- Do not let the engine labour. Never lug the engine. With a manual gearbox, shift to the next lower gear. This rule applies at all times, not just during the running-in period.
- After the first 800 km (500 mi), change the engine oil on vehicles with the LT1 engine and Z51 package, or the LT4 engine.

For the first 2.414 km (1.500 mi):

- Do not participate in track events, sport driving schools, or similar activities.
- Check engine oil with every refuelling and add if necessary. Oil and fuel consumption may be higher than normal.

Front Air Dam

If equipped, the front air dam has minimal ground clearance.

Under normal operation, the components will occasionally contact some road surfaces (speed bumps, driveway ramps, etc.). This can be heard inside the vehicle as a scraping noise. This is normal and does not indicate a problem.

Use care when approaching bumps or objects on road surfaces and avoid them when possible.

Carbon Fibre

This vehicle may be equipped with carbon fibre parts. Retailer-installed accessories may also contain carbon fibre. Some vehicles have a carbon fibre splitter and rocker extension. Do not stand on the rocker extension or use it as a step, as it could break.

Warning

The exposed edges of carbon fibre parts can be sharp when damaged. You or others could be injured. Use caution when washing the vehicle, coming in contact with damaged carbon fibre parts, or removing these parts. See your dealer for replacement.

Ignition Positions

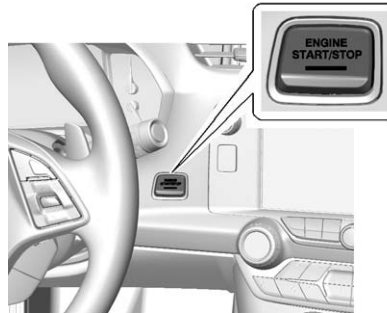

The vehicle has an electronic keyless ignition with pushbutton start.

Pressing the button cycles it through three modes: ACC/ACCESSORY, ON/RUN/START, and Stopping the Engine/OFF.

The Remote Keyless Entry (RKE) transmitter must be in the vehicle for the system to operate. If the pushbutton start is not working, the vehicle may be near a strong radio antenna signal causing interference to the Keyless Access system. See *Remote Keyless Entry (RKE) System Operation* ⇨ 25.

To shift out of P (Park), the vehicle must be in ON/RUN and the brake pedal must be applied.

Stopping the Engine/OFF (No Indicator Lights) : When the vehicle is stopped, press the ENGINE START/STOP button once to turn the engine off.

If the vehicle is in P (Park), the ignition will turn off, and Retained Accessory Power (RAP) will remain active. See *Retained Accessory Power (RAP)* ⇨ 171.

Automatic Transmission

If the vehicle is not in P (Park), the ignition will return to ACC/ACCESSORY and display a message in the Driver Information Centre (DIC). See *Transmission Messages* ⇨ 125. When the vehicle is shifted into P (Park), the ignition system will switch to OFF.

Manual Gearbox

If the vehicle is stationary, the ignition will turn OFF, and Retained Accessory Power (RAP) will remain active. See *Retained Accessory Power (RAP)* ⇨ 171.

Do not turn the engine off when the vehicle is moving. This will cause a loss of power assist in the brake and steering systems and disable the airbags.

If the vehicle must be shut off in an emergency:

1. Brake using a firm and steady pressure. Do not pump the brakes repeatedly. This may deplete power assist, requiring increased brake pedal force.
2. Shift the vehicle to N (Neutral). This can be done while the vehicle is moving. After shifting to N (Neutral), firmly apply the brakes and steer the vehicle to a safe location.
3. Come to a complete stop. Shift to P (Park) with an automatic transmission or Neutral with a manual gearbox. Turn the ignition to Stopping the Engine/OFF.
4. Apply the parking brake. See *Electric Parking Brake* ⇨ 182.

Warning

Turning off the vehicle while moving may cause loss of power assistance in the brake and

(Continued)

Warning (Continued)

steering systems and disable the airbags. While driving, only shut the vehicle off in an emergency.

If the vehicle cannot be pulled over, and must be shut off while driving, press and hold the ENGINE START/STOP button for longer than two seconds, or press twice within five seconds.

ACC/ACCESSORY (Amber Indicator Light) : This mode allows the use of some electrical accessories when the engine is off.

With the ignition off, pressing the button once without the brake pedal applied will place the ignition system in ACC/ACCESSORY.

The ignition will switch from ACC/ACCESSORY to Stopping the Engine/OFF after five minutes to prevent battery rundown.

ON/RUN/START (Green Indicator Light) : This mode is for driving and starting. With the ignition off, and the brake pedal applied, pressing

the button once will place the ignition system in ON/RUN/START. Once engine cranking begins, release the button. Engine cranking will continue until the engine starts. See *Starting the Engine* ⇨ 169. The ignition will then remain in ON/RUN.

Service Only Mode

This power mode is available for service and diagnostics, and to verify the proper operation of the malfunction indicator lamp as may be required for emission inspection purposes. With the vehicle off, and the brake pedal not applied, pressing and holding the button for more than five seconds will place the vehicle in Service Only Mode. The instruments and audio systems will operate as they do in ON/RUN, but the vehicle will not be able to be driven. The engine will not start in Service Only Mode. Press the button again to turn the vehicle off.

Starting the Engine

Place the transmission in the proper gear.

Caution

If you add electrical parts or accessories, you could change the way the engine operates. Any resulting damage would not be covered by the vehicle warranty. See *Add-On Electrical Equipment* ⇨ 201.

Automatic Transmission

Move the shift lever to P (Park) or N (Neutral). To restart the vehicle when it is already moving, use N (Neutral) only.

Caution

Do not try to shift to P (Park) if the vehicle is moving. If you do, you could damage the transmission. Shift to P (Park) only when the vehicle is stopped.

Manual Gearbox

The shift lever should be in Neutral and the parking brake engaged. Hold the clutch pedal down to the floor and start the engine.

The RKE transmitter must be inside the vehicle for the ignition to work.

Cell phone chargers can interfere with the operation of the Keyless Access system. Battery chargers should not be plugged in when starting or turning off the engine.

To start the vehicle:

1. For vehicles with an automatic transmission, press the brake pedal, then press the ENGINE START/STOP button on the instrument panel. For vehicles with a manual transmission, press the clutch pedal first, then press the ENGINE START/STOP button.

If there is no RKE transmitter in the vehicle or if there is something causing interference with it, the DIC will display a message. See *Key and Lock Messages* ⇨ 120.

2. When the engine begins cranking, let go of the button and the engine cranks automatically until it starts. If the battery in the RKE transmitter is weak, the DIC will display a message. The vehicle can still be driven.

See “Starting the Vehicle with a Low Transmitter Battery” under *Remote Keyless Entry (RKE) System Operation* ⇨ 25. If the remote transmitter battery is dead, insert it into the steering column transmitter pocket to enable engine starting. See “NO REMOTE KEY WAS DETECTED PLACE KEY IN TRANSMITTER POCKET THEN START YOUR VEHICLE” under *Key and Lock Messages* ⇨ 120.

3. Do not race the engine immediately after starting it. Operate the engine and transmission gently until the oil warms up and lubricates all moving parts.

4. If the engine does not start and no DIC message is displayed, wait 15 seconds before trying again to let the cranking motor cool down.

If the engine does not start after five to 10 seconds, especially in very cold weather (below -18°C or 0°F), it could be flooded with too much petrol. Try pushing the accelerator pedal all the way to the floor while cranking for up to 15 seconds maximum. Wait at least 15 seconds between each try, to allow the cranking motor to cool down. When the engine starts, let go of the accelerator. If the vehicle starts briefly but then stops again, repeat these steps. This clears the extra petrol from the engine.

Caution

Cranking the engine for long periods of time, by returning the ignition to the START position immediately after cranking has ended, can overheat and damage the cranking motor, and drain the battery. Wait at least 15 seconds between each try, to let the cranking motor cool down.

Stopping the Engine

If the vehicle has an automatic transmission, move the shift lever to P (Park) and press and hold the ENGINE START/STOP button on the instrument panel, until the engine shuts off. If the gear lever is not in P (Park), the engine shuts off and the vehicle goes into the accessory mode. The DIC displays SHIFT TO PARK. Once the shift lever is moved to P (Park), the vehicle turns off. If the vehicle has a manual transmission, move the shift lever to R (Reverse) and set the

parking brake after turning off the engine by pressing and holding the ENGINE START/STOP button.

If the RKE transmitter is not detected inside the vehicle when it is turned to off, the DIC displays a message.

See *Key and Lock Messages* ⇨ 120.

Retained Accessory Power (RAP)

These vehicle accessories can be used for up to 10 minutes after the engine is turned off:

- Audio System
- Power Windows

These features continue to work up to 10 minutes after the engine is turned off or until either door is opened. If a door is opened, the power windows and audio system will shut off.

Shifting Into Park

1. Hold the brake pedal down and set the parking brake. See *Electric Parking Brake* ⇨ 182.

2. Move the shift lever into P (Park) by holding in the button on the lever and pushing the lever all the way toward the front of the vehicle.
3. Press the ENGINE START/STOP button to turn the engine off.

Leaving the Vehicle with the Engine Running (Automatic Transmission)

Warning

It can be dangerous to leave the vehicle with the engine running. It could overheat and catch fire.

It is dangerous to get out of the vehicle if the shift lever is not fully in P (Park) with the parking brake firmly applied. The vehicle can roll.

Do not leave the vehicle when the engine is running. If you have left the engine running, the vehicle can move suddenly. You or others

(Continued)

Warning (Continued)

could be injured. To be sure the vehicle will not move, even when you are on fairly level ground, always set the parking brake and move the shift lever to P (Park). See *Shifting Into Park* ⇨ 171.

If you have to leave the vehicle with the engine running, be sure the vehicle is in P (Park) and the parking brake is firmly applied before you leave it. After you have moved the gear lever into P (Park), hold down the regular brake pedal. See if you can move the shift lever away from P (Park) without first pushing the button on the lever. If you can, it means that the shift lever was not fully locked into P (Park).

Torque Lock (Automatic Transmission)

If you are parking on a hill and you do not shift the transmission into P (Park) properly, the weight of the vehicle may put too much force on

the parking pawl in the transmission. You may find it difficult to pull the shift lever out of P (Park). This is called “torque lock.” To prevent torque lock, set the parking brake and then shift into P (Park) properly before you leave the driver seat. To find out how, see “Shifting Into P (Park)” previously in this section.

When you are ready to drive, move the shift lever out of P (Park) before you release the parking brake.

If torque lock does occur, you may need to have another vehicle push yours a little uphill to take some of the pressure from the transmission parking pawl, so you can pull the shift lever out of P (Park).

Shifting out of Park

Shift lock release prevents shifting out of P (Park) unless the vehicle is running or in accessory mode and the brake pedal is applied.

The shift lock release is always functional except in the case of an uncharged or low voltage (less than 9-volt) battery. See *Jump Starting* ⇨ 269.

To shift out of P (Park):

1. Apply the brake pedal.
2. Release the parking brake. See *Electric Parking Brake* ⇨ 182.
3. Press the shift lever button.
4. Move the shift lever to the desired position.

If you still are unable to shift out of P (Park):

1. Fully release the shift lever button, and let go of the shift knob.
2. While holding down the brake pedal, press the shift lever button again.
3. Move the shift lever to the desired position.

If you still cannot move the gear lever from P (Park), consult your dealer or a professional towing service.

Parking

Warning

Do not park the vehicle on an easily ignitable surface. The high temperature of the exhaust system could ignite the surface.

Always apply parking brake. See *Parking Brake* or *Electric Parking Brake*.

Switch off the engine.

If the vehicle is on a level surface or uphill slope, engage 1 (First) gear or set the selector lever to P (Park) before switching off the ignition. On an uphill slope, turn the front wheels away from the kerb.

(Continued)

Warning (Continued)

If the vehicle is on a downhill slope, engage R (Reverse) gear or set the selector lever to P (Park) before switching off the ignition. Turn the front wheels towards the kerb.

Switch off the ignition. Turn the steering wheel until the steering wheel lock engages. Turn the ignition key to position OFF and remove it. Turn the steering wheel until the steering wheel lock is felt to engage.

For vehicles with automatic transmission, the key can only be removed when the selector lever is in the P (Park) position.

Parking over Things That Burn **Warning**

Things that can burn could touch hot exhaust parts under the vehicle and ignite. Do not park over papers, leaves, dry grass, or other things that can burn.

Active Fuel Management®

This system allows the engine to operate on either all or half of its cylinders, depending on the driving conditions. With a manual transmission, the system is only active in Eco mode. With an automatic transmission, the system is available in all modes, but is more aggressive in Eco mode. See *Driver Mode Control* ⇨ 187.

When less power is required, such as cruising at a constant vehicle speed, the system will operate in the half cylinder mode, allowing the vehicle to achieve better fuel economy. When greater power demands are required, such as accelerating from a stop, overtaking, or merging onto a freeway, the system will maintain full-cylinder operation.

Engine Exhaust

Warning

Engine exhaust contains carbon monoxide (CO) which cannot be seen or smelled. Exposure to CO can cause unconsciousness and even death.

Exhaust may enter the vehicle if:

- The vehicle idles in areas with poor ventilation (parking garages, tunnels, deep snow that may block underbody airflow or exhaust pipes).
- The exhaust smells or sounds strange or different.
- The exhaust system leaks due to corrosion or damage.
- The vehicle exhaust system has been modified, damaged, or improperly repaired.

(Continued)

Warning (Continued)

- There are holes or openings in the vehicle body from damage or aftermarket modifications that are not completely sealed.

If unusual fumes are detected or if it is suspected that exhaust is coming into the vehicle:

- Drive it only with the windows completely down.
- Have the vehicle repaired immediately.

Never park the vehicle with the engine running in an enclosed area such as a garage or a building that has no fresh air ventilation.

Running the Vehicle While Parked

It is better not to park with the engine running.

If the vehicle is left with the engine running, follow the proper steps to be sure the vehicle will not move. See *Shifting Into Park* ⇨ 171 and *Engine Exhaust* ⇨ 174. If the vehicle has a manual gearbox, see *Parking* ⇨ 172.

Automatic Transmission

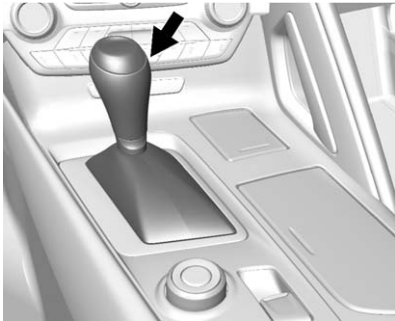

There are several different positions for the shift lever.

P : This position locks the rear wheels. It is the best position to use when starting the engine because the vehicle cannot move easily.

Warning

It is dangerous to get out of the vehicle if the shift lever is not fully in P (Park) with the parking brake firmly applied. The vehicle can roll.

Do not leave the vehicle when the engine is running. If you have left the engine running, the vehicle can move suddenly. You or others could be injured. To be sure the vehicle will not move, even when you are on fairly level ground, always set the parking brake and move the shift lever to P (Park). See *Shifting Into Park* ⇨ 171.

Be sure the shift lever is fully in P (Park) before starting the engine.

The vehicle has an automatic transmission shift lock control system. Fully apply the brakes and then press the shift lever button before shifting from P (Park) when the vehicle is running. If the vehicle cannot be shifted out of P (Park), ease pressure on the shift lever and

push the shift lever all the way into P (Park) as brake application is maintained. Then press the shift lever button and move the shift lever into another gear. See *Shifting out of Park* ⇨ 172.

R : Use this gear to reverse.

Caution

Shifting to R (Reverse) while the vehicle is moving forward could damage the transmission. The repairs would not be covered by the vehicle warranty. Shift to R (Reverse) only after the vehicle is stopped.

To rock the vehicle back and forth to get out of snow, ice, or sand without damaging the transmission, see *If the Vehicle Is Stuck* ⇨ 162.

N : In this position, the engine does not connect with the wheels. To restart the engine when the vehicle is already moving, use N (Neutral) only. If the vehicle needs towing, see *Towing the Vehicle* ⇨ 272.

Warning

Shifting into a drive gear while the engine is running at high speed is dangerous. Unless your foot is firmly on the brake pedal, the vehicle could move very rapidly. You could lose control and hit people or objects. Do not shift into a drive gear while the engine is running at high speed.

Caution

Shifting out of P (Park) or N (Neutral) with the engine running at high speed may damage the transmission. The repairs would not be covered by the vehicle warranty. Be sure the engine is not running at high speed when shifting the vehicle.

D :

This position is for normal driving. It provides the best fuel economy. If more power is needed for passing, push the pedal down to achieve the desired level of acceleration.

Downshifting the transmission in slippery road conditions could result in skidding. See “Skidding” under *Loss of Control* ⇨ 153.

The transmission can be shifted like a manual transmission using the paddle shift controls while in D (Drive). See *Manual Mode* ⇨ 176.

M : In M (Manual Mode), the transmission can be shifted like a manual transmission using the paddle shift controls. See *Manual Mode* ⇨ 176.

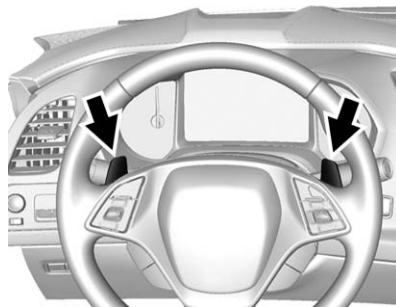
Manual Mode**Manual Paddle Shift**

When the shift lever is moved to M (Manual Mode), the transmission enters Manual Mode. The transmission will hold the current gear until a change is requested. The paddles on the steering wheel can be used to manually upshift or downshift the transmission. The right (+) plus paddle upshifts, and the left (-) minus paddle downshifts.



When using the Manual Paddle Shift feature while in M (Manual Mode), the current gear will be displayed in the instrument cluster, or the Head-Up Display (HUD), if equipped. See *Head-Up Display (HUD)* ⇨ 113.

When accelerating the vehicle from a stop in snowy and icy conditions, shifting to 2 (Second) gear allows the vehicle to gain more traction.

The Manual Paddle Shift system can be deactivated by moving the shift lever from M (Manual Mode) back to D (Drive).

When the shift lever is in D (Drive), press either the right (+) plus paddle or the left (-) minus paddle to place the transmission in Temporary Manual Paddle Shift mode. The gear indicator by the shift lever, in the cluster, and in the HUD will display an M, even though the shift

lever is still in D (Drive). To exit the system, hold the (+) plus paddle for more than one second. The system will return to automatic shifting after six seconds of cruising at a steady speed, no manual shifts, no aggressive cornering, or when the vehicle comes to a stop.

While the Manual Paddle Shift gear selection system is active, the transmission will automatically downshift through the gears as the vehicle slows. The transmission will select 1 (First) gear as the vehicle stops. From a stop, the vehicle will start from and hold 1 (First) gear unless the manual paddle shifts are used to shift into a different gear, or D (Drive) is selected.

If the left (-) minus paddle is held down briefly, the transmission will downshift to the lowest gear possible for the vehicle speed. If the paddle continues to be held as the vehicle slows, downshifts will continue to occur as vehicle speed allows. This feature also works while in Temporary Manual Paddle Shift mode, but the driver must first press and release the (-) minus

paddle to enter Temporary Manual Paddle Shift mode, then press and hold the (-) minus paddle briefly.

The Manual Paddle Shift system will not allow either an upshift or a downshift if the vehicle speed is too fast or too slow, nor will it allow a start from 3 (Third) or higher gear.

If upshifting does not occur when needed, vehicle speed will be limited to protect the engine.

When a requested shift is denied due to the speed restrictions shown, a DIC message will be displayed, and the current gear remains displayed in the cluster and HUD.

Manual Paddle Shift operation is available for use with cruise control. See *Cruise Control* ⇨ 193.

The vehicle speeds required for Manual Paddle Shift upshifts depend on several vehicle inputs, which will vary the allowed up-shift speed by a few km/h (mph).

For Vehicles with a 2.41:1 Axle Ratio (RPO GXB)

- Upshifts to 3 (Third) gear require approximately 25 km/h (16 mph).
- Upshifts to 4 (Fourth) gear require approximately 37 km/h (23 mph).
- Upshifts to 5 (Fifth) gear require approximately 48 km/h (30 mph).
- Upshifts to 6 (Sixth) gear require approximately 60 km/h (37 mph).
- Upshifts to 7 (Seventh) gear require approximately 74 km/h (46 mph).
- Upshifts to 8 (Eighth) gear require approximately 95 km/h (59 mph).

To prevent damage to the powertrain, Manual Paddle downshifts to a lower gear cannot be done above certain speeds. The maximum speed allowed for downshifting of gears 1 (First) through 6 (Sixth) are:

- Into 6 (Sixth) gear over 309 km/h (192 mph).

- Into 5 (Fifth) gear over 243 km/h (151 mph).
- Into 4 (Fourth) gear over 183 km/h (114 mph).
- Into 3 (Third) gear over 149 km/h (93 mph).
- Into 2 (Second) gear over 100 km/h (62 mph).
- Into 1 (First) gear over 62 km/h (39 mph).

For Vehicles with a 2.73:1 Axle Ratio (RPO GU2)

- Upshifts to 3 (Third) gear require approximately 24 km/h (15 mph).
- Upshifts to 4 (Fourth) gear require approximately 34 km/h (21 mph).
- Upshifts to 5 (Fifth) gear require approximately 43 km/h (27 mph).
- Upshifts to 6 (Sixth) gear require approximately 55 km/h (34 mph).
- Upshifts to 7 (Seventh) gear require approximately 64 km/h (40 mph).

- Upshifts to 8 (Eighth) gear require approximately 82 km/h (51 mph).

To prevent damage to the powertrain, Manual Paddle downshifts to a lower gear cannot be done above certain speeds. The maximum speed allowed for downshifting of gears 1 (First) through 7 (Seventh) are:

- Into 7 (Seventh) gear over 321 km/h (199 mph).
- Into 6 (Sixth) gear over 272 km/h (169 mph).
- Into 5 (Fifth) gear over 214 km/h (133 mph).
- Into 4 (Fourth) gear over 161 km/h (100 mph).
- Into 3 (Third) gear over 131 km/h (93 mph).
- Into 2 (Second) gear over 88 km/h (62 mph).
- Into 1 (First) gear over 55 km/h (39 mph).

If an upshift is not requested as the engine speed approaches fuel shutoff rpm, the engine speed will be limited to protect the engine. See *Rev Counter* ⇨ 100.

Gear Shifting Light



The gear shift light illuminates in the instrument cluster when a gear upshift is recommended for best fuel economy or performance, depending on the drivers input.

Manual Gearbox

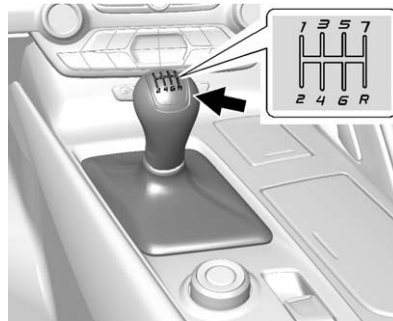

This is the 7-speed manual gearbox shift pattern.

To operate:

1 (First) : Press the clutch pedal and shift into 1 (First). Then slowly let up on the clutch pedal as the accelerator pedal is pressed.

This can be done if the vehicle is going less than 64 km/h (40 mph). If the vehicle is at a complete stop and it is hard to shift into 1 (First), put the gear lever in Neutral and let

up on the clutch. Then press the clutch pedal back down and shift into 1 (First).

2 (Second) : Press the clutch pedal while letting up on the accelerator pedal and shift into 2 (Second). Then, slowly let up on the clutch pedal as the accelerator pedal is pressed.

3 (Third), 4 (Fourth), 5 (Fifth), 6 (Sixth), and 7 (Seventh) : Shift into 3 (Third), 4 (Fourth), 5 (Fifth), 6 (Sixth), and 7 (Seventh) the same way as for 2 (Second).

To stop, let up on the accelerator pedal and press the brake pedal. Just before the vehicle stops, press the clutch pedal and the brake pedal and shift to Neutral.

Neutral : Use to start or idle the engine. Neutral is the centre position of the shift pattern.

R (Reverse) : To back up, push the clutch pedal and shift into R (Reverse). Additional pressure may be needed to move the lever past 5 (Fifth) and 6 (Sixth) into

R (Reverse). Let up on the clutch pedal slowly while pressing the accelerator pedal.

The vehicle can be safely shifted into R (Reverse) while the vehicle is moving less than 5 km/h (3 mph). If the vehicle is going faster than that, R (Reverse) is locked out.

Shift Speeds

Use the following shift speeds, shown in km/h (mph), for the best fuel economy.

1 to 4	27 (17)
4 to 5	40 (25)
5 to 6	64 (40)
6 to 7	72 (45)

Caution

When shifting gears, do not move the shift lever around unnecessarily. This may damage the transmission. Shift directly into the next gear.

Shift Indicator



The shift indicator illuminates in the instrument cluster when a gear shift is recommended for best fuel economy. When the arrow is pointed up, an upshift is recommended. When the arrow is pointed down, a downshift is recommended. The number displayed with the arrow indicates the recommended gear.

Downshifting

Do not downshift into the gear at a speed greater than shown:

1 (First)	72 km/h (45 mph)
2 (Second)	107 km/h (67 mph)
3 (Third)	160 km/h (100 mph)
4 (Fourth)	233 km/h (145 mph)

Caution

When downshifting, if more than one gear is skipped, or the engine is racing when the clutch pedal is released, the engine, clutch, driveshaft or transmission could be damaged.

If the engine speed drops below 900 rpm, or if the engine is not running smoothly, downshift to the next lower gear. It may be necessary to downshift two or more gears.

The transmission has a spring that centres the gear lever near 3 (Third) and 4 (Fourth). This spring helps to know what gear the gear lever is in when shifting. Be careful when shifting from 1 (First) to 2 (Second) or downshifting from 7 (Seventh) to 6 (Sixth). The spring will try to pull the shift lever toward 4 (Fourth) and 3 (Third). Move the lever into 2 (Second) or 6 (Sixth) and do not let the gear lever move in the direction of the pulling, or it could shift from 1 (First) to 4 (Fourth) or from 7 (Seventh) to 4 (Fourth).

If the vehicle is not changed up a gear as the engine speed approaches fuel shut off rpm, the engine speed will be limited to protect the engine. See *Rev Counter* ⇨ 100.

Active Rev Match

Vehicles equipped with a manual gearbox have Active Rev Match (ARM). ARM aids in smoother shifting by matching the engine speed to the next selected gear. By monitoring gear lever and clutch operation, ARM adjusts engine speed to match a calibrated value based on gear selection. On upshifts and downshifts, engine speed will be increased and decreased to match vehicle road speed and transmission gear position. ARM is maintained for a few seconds between shifts, then deactivates if the shift is not completed.

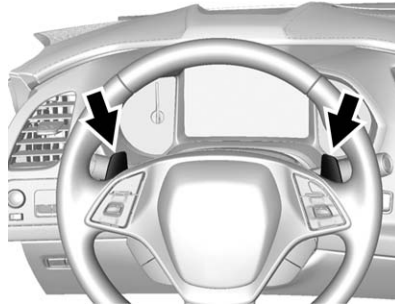

The system is activated and deactivated by pressing either of the paddles marked REV MATCH on the steering wheel. The system must be activated with each new ignition cycle.



A gear indicator in the instrument cluster displays the current gear selected:

- When ARM is activated, the gear number is amber.
- When ARM is deactivated, the gear number is white.
- A white dash indicates that service is required. ARM will be disabled, and the malfunction indicator lamp will be on. See *Malfunction Indicator Lamp (Check Engine Light)* ⇨ 104. The clutch and manual gearbox will continue to operate normally.

ARM will also:

- Be active above 14 km/h (9 mph).
- Match engine speed up to 5400 rpm.
- Not operate when the accelerator pedal is applied.
- Be disabled when the coolant temperature is below 0 °C (32 °F).

Brakes

Antilock Brake System (ABS)

This vehicle has ABS, an advanced electronic braking system that helps prevent a braking skid.

When the vehicle begins to drive away, ABS checks itself.

A momentary motor or clicking noise might be heard while this test is going on, and it might even be noticed that the brake pedal moves a little. This is normal.



If there is a problem with ABS, this warning light stays on. See *Antilock Brake System (ABS) Warning Light* ⇨ 107.

If driving safely on a wet road and it becomes necessary to slam on the brakes and continue braking to

avoid a sudden obstacle, a computer senses the wheels are slowing down. If one of the wheels is about to stop rolling, the computer will separately work the brakes at each wheel.

ABS can change the brake pressure to each wheel, as required, faster than any driver could. This can help you steer around the obstacle while braking hard.

As the brakes are applied, the computer keeps receiving updates on wheel speed and controls braking pressure accordingly.

Remember: ABS does not change the time needed to get a foot up to the brake pedal or always decrease stopping distance. If you get too close to the vehicle in front of you, there will not be enough time to apply the brakes if that vehicle suddenly slows or stops. Always leave enough room up ahead to stop, even with ABS.

Using ABS

Do not pump the brakes. Just hold the brake pedal down firmly and let ABS work. You may hear the ABS pump or motor operating and feel the brake pedal pulsate. This is normal.

Braking in Emergencies

ABS allows you to steer and brake at the same time. In many emergencies, steering can help more than even the very best braking.

Electric Parking Brake

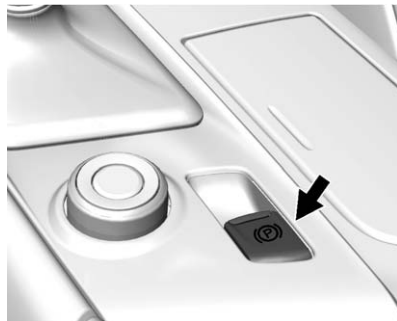

The vehicle has an Electric Parking Brake (EPB). The switch is on the centre console. The EPB can always be activated, even if the ignition is off. To prevent draining the battery, avoid repeated cycles of the EPB when the engine is not running.

The system has a red handbrake status light and an amber handbrake warning light. See *Electric Parking Brake Light* ⇨ 106 and *Service Electric Parking Brake Light* ⇨ 106. There are also handbrake-related Driver Information Centre (DIC) messages. See *Brake System Messages* ⇨ 117. In case of insufficient electrical power, the EPB cannot be applied or released.

Before leaving the vehicle, check the red handbrake status light to ensure that the handbrake is applied.

EPB Apply

To apply the EPB:

1. Be sure the vehicle is at a complete stop.

2. Lift up the EPB switch momentarily.

The red handbrake status light will flash and then stay on once the EPB is fully applied. If the red handbrake status light flashes continuously, then the EPB is only partially applied or there is a problem with the EPB. A DIC message will display. Release the EPB and try to apply it again. If the light does not come on, or keeps flashing, have the vehicle serviced. Do not drive the vehicle if the red handbrake status light is flashing. See your dealer. See *Electric Parking Brake Light* ⇨ 106.

If the amber handbrake warning light is on, lift up on the EPB switch and hold it up. Continue to hold the switch until the red handbrake status light remains on. If the amber handbrake warning light remains on, see your dealer.

If the EPB is applied while the vehicle is moving, the vehicle will decelerate as long as the switch is

held up. If the switch is held up until the vehicle comes to a stop, the EPB will remain applied.

The vehicle may automatically apply the EPB in some situations when the vehicle is not moving. This is normal, and is done to periodically check the correct operation of the EPB system.

If the EPB fails to apply, the rear wheels should be blocked to prevent vehicle movement.

EPB Release

To release the EPB:

1. Place the ignition in the ACC/ACCESSORY or ON/RUN/START position.
2. Apply and hold the brake pedal.
3. Push down momentarily on the EPB switch.

The EPB is released when the red handbrake status light is off.

If the amber handbrake warning light is on, release the EPB by pushing down on the EPB switch

and holding it down. Continue to hold the switch until the red handbrake status light is off. If either light stays on after release is attempted, see your dealer.

Caution

Driving with the parking brake on can overheat the brake system and cause premature wear or damage to brake system parts. Make sure that the parking brake is fully released and the brake warning light is off before driving.

Automatic EPB Release

The EPB will automatically release if the vehicle is running, placed into gear and an attempt is made to drive away. Avoid rapid acceleration when the EPB is applied, to preserve parking brake lining life.

The EPB can also be used to prevent roll back for vehicles with a manual gearbox starting on a hill. When no roll back is desired, an applied EPB will allow both feet to be used for the clutch and

accelerator pedals in preparation for starting the vehicle moving in the intended direction. In this case, there is no need to push the switch to release the EPB.

Brake Assist

The Brake Assist feature is designed to assist the driver in stopping or decreasing vehicle speed in emergency driving conditions. This feature uses the stability system hydraulic brake control module to supplement the power brake system under conditions where the driver has quickly and forcefully applied the brake pedal in an attempt to quickly stop or slow down the vehicle. The stability system hydraulic brake control module increases brake pressure at each corner of the vehicle until the ABS activates. Minor brake pedal pulsation or pedal movement during this time is normal and the driver should continue to apply the brake pedal as the driving situation dictates. The Brake Assist feature will automatically disengage when the

brake pedal is released or brake pedal pressure is quickly decreased.

Hill Start Assist (HSA)

If equipped, HSA may automatically activate when the vehicle is stopped on a gradient. This feature is designed to prevent the vehicle from rolling, either forward or rearward, during vehicle drive off. During the transition from releasing the brake pedal to accelerating to drive off on a grade, HSA holds the braking pressure to prevent rolling. HSA will not activate if the vehicle is in a drive gear and facing downhill or if the vehicle is facing uphill and in R (Reverse).

Ride Control Systems

Traction Control/ Electronic Stability Control

The vehicle has a Traction Control System (TCS) and a StabiliTrak system. These systems help limit wheel spin and assist the driver in maintaining control, especially on slippery road conditions.

TCS activates if it senses that the rear wheels are spinning too much or are beginning to lose traction. When this happens, TCS applies the brakes to the spinning wheel and reduces engine power (by closing the throttle and managing engine spark) to limit wheel spin.

StabiliTrak activates when the vehicle senses a difference between the intended path and the direction the vehicle is actually travelling. StabiliTrak selectively applies braking pressure to any one of the vehicle wheel brakes to assist the driver in keeping the vehicle on the intended path.

If cruise control is being used when TCS begins to limit wheel spin, the cruise control will automatically disengage. Cruise control may be reengaged when road conditions allow. See *Cruise Control* ⇨ 193.

Both systems come on automatically when the vehicle is started and begins to move. The systems may be heard or felt while they are operating or while performing diagnostic checks. This is normal and does not mean there is a problem with the vehicle.

It is recommended to leave both systems on for normal driving conditions, but it may be necessary to turn TCS off if the vehicle gets stuck in sand, mud, ice, or snow. See *If the Vehicle Is Stuck* ⇨ 162 and “Turning the Systems Off and On” later in this section.



The indicator light for both systems is in the instrument cluster. This light will:

- Flash when TCS is limiting wheel spin.
- Flash when StabiliTrak is activated.
- Turn on and stay on when either system is not working.

If either system fails to turn on or to activate, a message displays in the Driver Information Centre (DIC), and  comes on and stays on to indicate that the system is inactive and is not assisting the driver in maintaining control. The vehicle is safe to drive, but driving should be adjusted accordingly.

If  comes on and stays on:

1. Stop the vehicle.
2. Turn the engine off and wait 15 seconds.
3. Start the engine.

Drive the vehicle. If  comes on and stays on, the vehicle may need more time to diagnose the problem. If the condition persists, see your dealer.





Turning the Systems Off and On







The TCS/StabiliTrak button is on the centre console.



Caution

Do not repeatedly brake or accelerate heavily when TCS is off. The vehicle driveline could be damaged.

To turn off only TCS, press and release the  button. The Traction Off light  illuminates in the instrument cluster. To turn TCS on again, press and release the  button. The Traction Off light  displayed in the instrument cluster will turn off.

If TCS is limiting wheel spin when the  button is pressed, the system will not turn off until the wheels stop spinning.

To turn off both TCS and StabiliTrak, press and hold the  button until the Traction Off light  and StabiliTrak OFF light  illuminate and stay on in the instrument cluster.

To turn TCS and StabiliTrak on again, press and release the  button. The Traction Off light  and StabiliTrak OFF light  in the instrument cluster turn off.

If the Tyre Pressure Monitor System (TPMS) is malfunctioning and the DIC displays SERVICE TYRE MONITOR SYSTEM, StabiliTrak will be affected as follows:

- StabiliTrak cannot be turned off by the driver.
- If StabiliTrak is off, it will be turned on automatically.
- Performance Traction Management is unavailable.
- StabiliTrak will feel different in aiding and maintaining directional control.

Adding accessories can affect the vehicle performance. See *Accessories and Modifications* ⇨ 203.

Driver Mode Control



The Driver Mode Selector knob is on the console behind the gear lever.

There are five modes for different driving conditions: Weather, Eco, Tour, Sport, and Track.

The vehicle will latch in the Eco mode with the start of each key cycle.

The outer ring turns to change the modes, which display in the instrument cluster.

Press the button in the centre of the knob for Stability Control and Traction Control, or if the vehicle is in Track mode with Performance Traction Management (PTM). See *Traction Control/Electronic Stability Control* ⇨ 185 or the information on PTM in *Competitive Driving Mode* ⇨ 190.

When PTM is active, the outer ring will change the PTM mode and the Driver mode will display in the instrument cluster.

Each mode is configured for use in different driving conditions. Use:

- Weather mode for rain and snow.
- Eco mode to improve fuel economy.
- Tour mode for comfortable normal driving.
- Sport mode for spirited on road driving.
- Track mode for track use.

There are 12 attributes that vary by mode shown below. Not all vehicles have all features, depending on the vehicle options.

Modes:	WEATHER	ECO <i>Default</i>	TOUR	SPORT	TRACK
Cluster Display	Tour	Tour	Tour	Sport	Track
Throttle Progression	Weather	Normal	Normal	Sport	Sport
Trans Shift Mode (if equipped)	Normal	Normal	Normal	Sport	Track
Active Fuel Management	Normal	Eco	Normal	Normal	Normal
Exhaust Mode	Eco	Eco	Tour	Sport	Track
Steering	Comfort	Comfort	Comfort	Sport	Track
StabiliTrak	Normal	Normal	Normal	Normal	Comp Mode Avail
Electronic Limited Slip	Mode 1	Mode 1	Mode 1	Modes 2 & 3	Modes 2 & 3
Magnetic Ride	Tour	Tour	Tour	Sport	Track
Launch Control	NA	NA	NA	NA	Available
Traction Control	Weather	Normal	Normal	Normal	Track
Performance Traction Management	Off	Off	Off	Off	Available

Driver Mode Selector Attributes Affected

The Gauge Cluster Display is configured for each mode when linked (default):

- Tour: Modern theme which features displays for audio and navigation.
- Sport: Classic easy to read Sports Car gauges.
- Track: Gauges design based on Corvette Racing display with lap timer.

Throttle Progression

Adjusts throttle sensitivity by selecting how quick or slow the throttle reacts to input.

Transmission Shift Mode – Paddle Shift Automatic

- Adjusts to either a smoother or firmer shift.
- Sport – Performance Algorithm Liftfoot (PAL) recognizes aggressive throttle maneuvers and holds lower gears for greater engine braking and

enhanced vehicle control when not using paddles. (Available in Sport or Track mode.)

- Track – Performance Algorithm Shift (PAS) recognises aggressive cornering, heavy braking, and high acceleration to select and hold lower gears when not using paddles.

Active Fuel Management (engine cylinder shuts off) 4-Cylinder Mode

- Normal with automatic transmission: The engine uses 8-cylinder mode when accelerating, but changes to 4-cylinder mode when coasting.
- With manual transmission: Active Fuel Management only active in Eco mode.
- Off in Manual mode with automatic transmission unless in Eco mode.
- Eco keeps the engine in 4-cylinder mode unless heavy acceleration is needed.

Exhaust (variable mode exhaust system)

Changes when the variable exhaust valves open.

Steering (Assist Effort)

Adjusts from a lighter steering feel to reduced assist for more steering feel.

Magnetic Ride Control

Adjusts the shock dampening firmness based on driving conditions to improve comfort and performance.

Launch Control

Available only in Track mode for maximum “off-the-line” acceleration when in PTM modes.

Stability Control

- Performance Track Management allows less computer control to permit some slide and drift and is selected with the  button – only available in Track mode.

- StabiliTrak can be turned off by pressing and holding the  button for 10 seconds.

PTM (Performance Traction Management)

- Available in Track mode.
- There are five selectable settings if Performance Traction Management is activated.

Competitive Driving Mode

Performance Traction Management (PTM), and Launch Control are systems designed to allow increased performance while accelerating and/or cornering. This is accomplished by regulating and optimising the engine, brakes and suspension performance. These modes are for use at a closed course race track and are not intended for use on public roads. They will not compensate for driver inexperience or lack of familiarity with the race track. Drivers who prefer to allow the system to have more control of the engine, brake,

and suspension are advised to turn the normal traction control and StabiliTrak systems on.

Caution

Attempting to shift when the drive wheels are spinning and do not have traction may cause damage to the transmission. Damage caused by misuse of the vehicle is not covered by the vehicle warranty. Do not attempt to shift when the drive wheels do not have traction.

Performance Traction Management

Performance Traction Management (PTM) integrates the Traction Control, StabiliTrak, and Magnetic Ride Control systems to provide improved and consistent performance when cornering. The amount of available engine power is based on the mode selected, track conditions, driver skill, and the radius of each corner.



This light is on when the vehicle is in the PTM Mode.

In order to select this optional handling mode, the vehicle mode must be Track. Then quickly press the TCS/StabiliTrak  button on the centre console two times. PERF TRAC 1 - WET ACTIVE HANDLING ON displays in the DIC.

To experience the performance benefit of this system, after entering a curve and at the point where you would normally start to increase acceleration, fully press the accelerator pedal. The PTM system will modify the level of engine power for a smooth and consistent corner exit.



To select a mode while in PTM, turn the Magnetic Ride Control/Performance Traction Management MODE SELECT knob on the centre console.

The PTM system contains five modes. These modes are selected by turning the Magnetic Ride Control/Performance Traction Management MODE SELECT knob on the centre console. Scroll up or down through modes 1–5 by turning the MODE SELECT knob to the right or left.

The following is a DIC display description and the recommended usage of each mode:

PERF TRAC 1 - WET ACTIVE HANDLING ON

- Intended for all driver skill levels.
- Wet or damp conditions only - not intended for use in heavy rain or standing water.
- StabiliTrak is on and engine power is reduced based on conditions.

PERF TRAC 2 – DRY ACTIVE HANDLING ON

- For use by less experienced drivers or while learning a new track.
- Dry conditions only.
- StabiliTrak is on and engine power is slightly reduced.

PERF TRAC 3 – SPORT ACTIVE HANDLING ON

- For use by drivers who are familiar with the track.
- Dry conditions only.



- Requires more driving skill than mode 2.
- StabiliTrak is on and more engine power is available than in mode 2.

PERF TRAC 4 – SPORT ACTIVE HANDLING OFF

- For use by drivers who are familiar with the track.
- Dry conditions only.
- Requires more driving skill than modes 2 or 3.
- StabiliTrak is off and available engine power is the same as mode 3.

PERF TRAC 5 – RACE ACTIVE HANDLING OFF

- For use by experienced drivers who are familiar with the track.
- Dry conditions only.
- Requires more driving skill than in other modes.
- StabiliTrak is off and engine power is available for maximum cornering speed.

Press and release the TCS/ StabiliTrak  button to turn off Performance Traction Management and return to the traction control and StabiliTrak systems. The traction control light  and StabiliTrak OFF light  will go out.

Launch Control (Track Mode Only)

A Launch Control feature is available, within PTM, on all vehicles to allow the driver to achieve high levels of vehicle acceleration in a straight line. Launch Control is a form of traction control that manages tyre spin while launching the vehicle. This feature is intended for use during closed course race events where consistent zero to 60 and quarter mile times are desirable.

Launch Control is only available when the following criteria are met:

- Any of the PTM modes are selected. The TCS light comes on the instrument panel and the appropriate DIC message displays.

- The vehicle is not moving.
- The steering wheel is pointing straight.

Manual Transmissions

- The clutch is pressed and the vehicle is in 1 (First) gear.
- The accelerator pedal is rapidly applied to wide open throttle.

The Launch Control feature will initially limit engine speed as the driver rapidly applies the accelerator pedal to wide open throttle. Allow the engine rpm to stabilise. A smooth, quick release of the clutch, while maintaining the fully pressed accelerator pedal, will manage wheel slip. Complete shifts as described in *Manual Gearbox* ⇨ 179.

Automatic Transmissions

- The brake pedal must be firmly pressed to the floor, equivalent to a panic brake event.
- The accelerator pedal is rapidly applied to wide open throttle. (If the vehicle rolls due to wide open throttle, release the

throttle, press the brake pedal more firmly, and re-apply the accelerator to wide open throttle.)

The Launch Control feature will initially limit engine speed as the driver rapidly applies the accelerator pedal to wide open throttle. Allow the engine rpm to stabilise. A smooth, quick release of the brake pedal, while maintaining the fully pressed accelerator pedal, will manage wheel slip.

After the vehicle is launched, the system continues in PTM.

PTM, and Launch Control are systems designed for a closed course race track and not intended for use on public roads. The systems are not intended to compensate for lack of driver experience or familiarity with the race track.

Limited-Slip Differential

The Electronic Limited-Slip Differential (ELSD) is automatically activated. ELSD actively monitors vehicle sensors and driver inputs to determine the amount of change for the conditions. With ELSD, the vehicle has:

- Enhanced high-speed control.
- Improved traction through corners, allowing more acceleration.
- More precise steering.
- Increased vehicle agility.
- Integration with StabiliTrak.

For vehicles with limited-slip differential, driven under severe conditions, the rear axle fluid should be changed. See *Competitive Driving Mode* ⇨ 190 and *Scheduled Maintenance* ⇨ 283.

Cruise Control

With cruise control, a speed of about 40 km/h (25 mph) or more can be maintained without keeping your foot on the accelerator. Cruise control does not work at speeds below about 40 km/h (25 mph).

Warning

Cruise control can be dangerous where you cannot drive safely at a steady speed. Do not use cruise control on winding roads or in heavy traffic.

Cruise control can be dangerous on slippery roads. On such roads, fast changes in tyre traction can cause excessive wheel slip, and you could lose control. Do not use cruise control on slippery roads.

If equipped with a manual gearbox, the cruise control will remain active when the gears are shifted. The cruise is disengaged if the clutch is pressed for several seconds.

If the Traction Control System (TCS) begins to limit wheel spin while you are using cruise control, the cruise control automatically disengages. See *Traction Control/Electronic Stability Control* ⇨ 185. When road conditions allow for using safely again, cruise control can be turned back on.

If the brakes are applied, cruise control disengages.

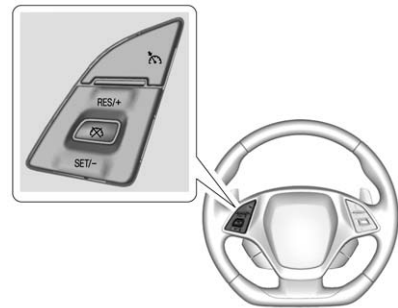



 (On/Off) : Press to turn cruise control on or off. A white indicator comes on in the instrument cluster when cruise is turned on.

RES/+ (Resume/Accelerate) : If there is a set speed in memory, press briefly to resume to that speed or press and hold to accelerate. If cruise control is already active, use to increase vehicle speed.

SET/- (Set/Coast) : Press briefly to set the speed and activate cruise control. If cruise control is already active, use to decrease vehicle speed.

⊗ (Cancel) : Press to disengage cruise control without erasing the set speed from memory.

Setting Cruise Control

If  is on when not in use, SET/- or RES/+ could get pressed and go into cruise when not desired. Keep  off when cruise is not being used.

1. Press  to turn the cruise system on.
2. Get up to the desired speed.
3. Press and release SET/- on the steering wheel.

4. Remove foot from the accelerator.

The cruise control indicator on the instrument cluster turns green after cruise control has been set to the desired speed. See *Instrument Cluster* ⇨ 95.

Resuming a Set Speed

If the cruise control is set at a desired speed and then the brakes are applied or  is pressed, the cruise control is disengaged without erasing the set speed from memory.

Once the vehicle reaches about 40 km/h (25 mph) or more, briefly press RES/+. The vehicle returns to the previous set speed.

Increasing Speed While Using Cruise Control

If the cruise control system is already activated,

- Press and hold RES/+ until the desired speed is reached, then release it.

- To increase vehicle speed in small increments, briefly press RES/+. For each press, the vehicle goes about 1.6 km/h (1 mph) faster.

The speedometer reading can be displayed in either English or metric units. See *Instrument Cluster* ⇨ 95. The increment value used depends on the units displayed.

Reducing Speed While Using Cruise Control

If the cruise control system is already activated:

- Press and hold SET/- until the desired lower speed is reached, then release it.
- To decrease the vehicle speed in small increments, briefly press SET/-. For each press, the vehicle goes about 1.6 km/h (1 mph) slower.

The speedometer reading can be displayed in either English or metric units. See *Instrument Cluster* ⇨ 95. The increment value used depends on the units displayed.

Overtaking Another Vehicle While Using Cruise Control

Use the accelerator pedal to increase the vehicle speed. When you take your foot off the pedal, the vehicle will slow down to the previously set cruise speed.

While pressing the accelerator pedal or shortly following the release to override cruise control, briefly pressing SET/- will result in cruise set to the current vehicle speed.

Using Cruise Control on Hills

How well the cruise control works on hills depends upon the vehicle speed, load and the steepness of the hills. When going up steep hills, you might have to apply the accelerator pedal to maintain your speed. When going downhill, you might have to brake or change to a lower gear to keep your speed down. If the brake pedal is applied, cruise control will disengage.

Cruise Control in Manual Paddle Shift Gear Selection



When the vehicle is in M (Manual Mode) and the manual paddle shift controls are not being used, cruise control operates in the same manner as D (Drive).

When the vehicle is in M (Manual Mode) and the manual paddle shift controls are being used, cruise control operates as follows:

- If cruise control is active and a gear is selected with the manual paddle shift controls, the vehicle speed is maintained in the driver selected gear and will not automatically upshift or downshift the transmission while the driver's gear selection is active.
- If driving in hilly terrain, cruise control may not be able to maintain vehicle speed if an upshift or downshift is not selected by the driver. While driving on hilly terrain and cruise control is active with a manual paddle gear lever selection, the driver must select the proper

gear for the terrain or select D (Drive) on the gear lever for full automatic transmission operation.

Ending Cruise Control

- Step lightly on the brake pedal.
- Press the clutch pedal for several seconds or shift to N (Neutral) (manual gearboxes).
- Shift the transmission to N (Neutral) (automatic transmissions).
- Press .
- To turn off cruise control, press .

Erasing Speed Memory

The cruise control set speed is erased from memory if  is pressed or if the ignition is turned off.

Driver Assistance Systems

Assistance Systems for Parking or Reversing

If equipped, the Rear Vision Camera (RVC) and Curb View Camera may help the driver park or avoid objects. Always check around the vehicle when parking or backing.

Rear Vision Camera (RVC)

When the vehicle is shifted into R (Reverse), the RVC displays an image of the area behind the vehicle in the centre console display. The previous screen displays when the vehicle is shifted out of R (Reverse) after a short delay. To return to the previous screen sooner, press a button on the infotainment system, shift into P (Park), or reach a vehicle speed of 8 km/h (5 mph).

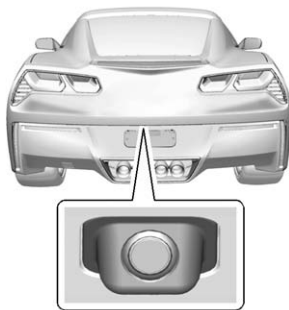

The camera is above the number plate.

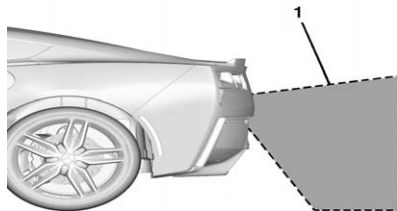

1. View displayed by the camera.

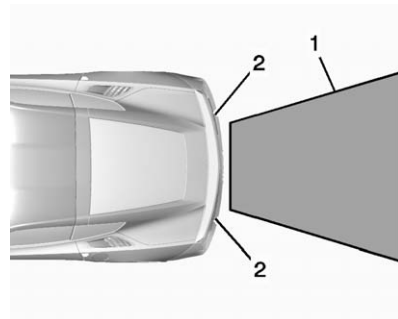

1. View displayed by the camera.
2. Corner of the rear bumper.

Displayed images may be farther or closer than they appear. The area displayed is limited and objects that are close to either corner of the bumper or under the bumper do not display.

Curb View Camera

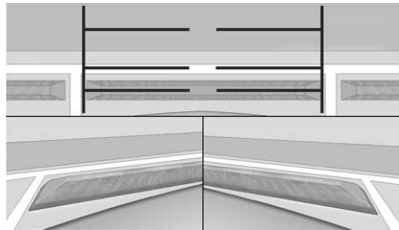

If equipped, a view of the area in front of the vehicle displays in the centre console screen. The display shows a front, top down view at the top and left and right front camera images on the bottom.

The front view shows after shifting from R (Reverse) to a forward gear, or by pressing CAMERA in the centre console, and when the vehicle is moving forward slower than 8 km/h (5 mph).

The front cameras are on both sides of the front fascia.

Warning

The camera(s) do not display children, pedestrians, bicyclists, crossing traffic, animals, or any other object outside of the cameras' field of view, below the bumper, or under the vehicle. Shown distances may be different from actual distances. Do not drive or park the vehicle using only these camera(s). Always check behind and around the vehicle before driving. Failure to use proper care may result in injury, death, or vehicle damage.

Turning the Features On or Off

To turn off the guidance lines:

1. On the infotainment system, press the Settings screen button, or turn the MENU knob to highlight Settings and press MENU.
2. Select Rear Camera.
3. Select Guidance Lines and then select Off or On.

Fuel

Use the recommended fuel for proper vehicle maintenance.

If equipped with the LT1 engine, use premium unleaded gasoline with a posted octane rating of 97 RON or higher. Regular unleaded petrol rated at 95 RON or higher can be used, but acceleration and fuel economy will be reduced, and an audible knocking noise may be heard. If this occurs, use a petrol rated at 97 RON or higher as soon as possible. Otherwise, the engine could be damaged. If heavy knocking is heard when using petrol rated at 97 RON or higher, the engine needs service.

If equipped with the LT4 supercharged engine, use premium unleaded gasoline with a posted octane rating of 97 RON or higher. If the octane is less than 97 RON, you could damage the engine and may void the vehicle warranty. If heavy knocking is heard when using petrol rated at 97 RON octane or higher, the engine needs service.

Use of Seasonal Fuels

Use summer and winter fuels in the appropriate season. The fuels industry automatically modifies the fuel for the appropriate season. If fuel is left in the vehicle tank for long periods of time, driving or starting could be affected. Drive the vehicle until the fuel is at one-half tank or less, then refuel with the current seasonal fuel.

Prohibited Fuels

Petrol containing oxygenates such as ethers and ethanol, as well as reformulated petrol, is available in some cities. If these petrols comply with the previously described specification, then they are acceptable to use. However, E85 (85% ethanol) and other fuels containing more than 15% ethanol must be used only in FlexFuel vehicles.

Caution

Do not use fuel containing methanol. It can corrode metal parts in the fuel system and also damage plastic and rubber parts. That damage would not be covered under the vehicle warranty.

Some petrol, mainly high octane racing petrol, can contain an octane-enhancing additive called methylcyclopentadienyl manganese tricarbonyl (MMT). Do not use petrol and/or fuel additives with MMT as they can reduce spark plug life and affect emission control system performance. The malfunction indicator lamp may turn on. If this occurs, see your dealer for service.

Fuel Additives

Petrol should contain detergent additives that help prevent engine and fuel system deposits from forming. Clean fuel injectors and intake valves will allow the emission control system to work properly.

Some petrol does not contain sufficient quantities of additive to keep fuel injectors and intake valves clean. To make up for this lack of detergency, add Fuel System Treatment PLUS to the fuel tank at every engine oil change or every 15 000 km (9 mi), whichever occurs first. It is available at your dealer.

Filling the Tank **Warning**

Fuel vapours and fuel fires burn violently and can cause injury or death.

- To help avoid injuries to you and others, read and follow all the instructions on the fuel pump island.
- Turn off the engine when refuelling.
- Keep sparks, flames, and smoking materials away from fuel.

(Continued)

Warning (Continued)

- Do not leave the fuel pump unattended.
- Do not use a mobile phone while refuelling.
- Do not reenter the vehicle while pumping fuel.
- Keep children away from the fuel pump and never let children pump fuel.
- Fuel can spray out if the refuelling nozzle is inserted too quickly. This spray can happen if the tank is nearly full, and is more likely in hot weather. Insert the refuelling nozzle slowly and wait for any hiss noise to stop prior to beginning to flow fuel

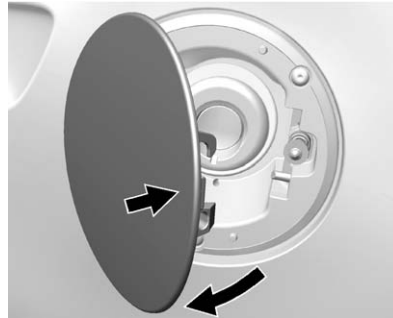

To open the fuel filler flap, push and release the rearward centre edge of the flap. The fuel door is locked when the vehicle doors are locked. Press  on the RKE transmitter to unlock. The driver door must be opened before the fuel door will unlock.

The vehicle has a capless refuelling system and does not have a fuel cap. The filling nozzle must be fully inserted and latched prior to starting fuel flow.

Warning

Overfilling the fuel tank by more than three clicks of a standard fill nozzle may cause:

- Vehicle performance issues, including engine stalling and damage to the fuel system.
- Fuel spills.
- Potential fuel fires.

Be careful not to spill fuel. Wait a few seconds before removing the nozzle. After initial shutoff, do not partially remove the nozzle to add more fuel as this will result in fuel spillage. Clean fuel from painted surfaces as soon as possible. See *Exterior Care* ⇨ 273.

Warning

If a fire starts while you are refuelling, do not remove the nozzle. Shut off the flow of fuel by shutting off the pump or by notifying the station attendant. Leave the area immediately.

Filling the Tank With a Portable Gas Can

If the vehicle runs out of fuel and must be filled from a portable petrol can:

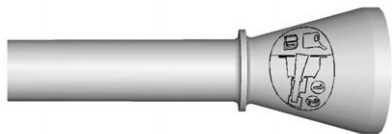

1. Locate the capless funnel adapter from inside the vehicle.

2. Insert and latch the funnel into the capless fuel system.

Warning

Attempting to refuel without using the funnel adapter may cause fuel spillage and damage the capless fuel system. This could cause a fire and you or others could be badly burned and the vehicle could be damaged.

3. Remove and clean the funnel adapter and return it to the storage location.

Filling a Portable Fuel Container**Warning**

Filling a portable fuel container while it is in the vehicle can cause fuel vapours that can ignite either by static electricity or other

(Continued)

Warning (Continued)

means. You or others could be badly burned and the vehicle could be damaged. Always:

- Use approved fuel containers.
- Remove the container from the vehicle, boot, or pickup bed before filling.
- Place the container on the ground.
- Place the nozzle inside the fill opening of the container before dispensing fuel, and keep it in contact with the fill opening until filling is complete.
- Fill the container no more than 95% full to allow for expansion.
- Do not smoke, light matches, or use lighters while pumping fuel.
- Avoid using mobile phones or other electronic devices.

Trailer Towing

General Towing Information

The vehicle is neither designed nor intended to tow a trailer.

Conversions and Add-Ons

Add-On Electrical Equipment

Warning

The Data Link Connector (DLC) is used for vehicle service and Emission Inspection/Maintenance testing. See *Malfunction Indicator Lamp (Check Engine Light)* ⇨ 104. A device connected to the DLC — such as an aftermarket fleet or driver-behaviour tracking device — may interfere with vehicle systems. This could affect vehicle operation and cause a crash. Such devices may also access information stored in the vehicle's systems.

Caution

Some electrical equipment can damage the vehicle or cause components to not work and would not be covered by the vehicle warranty. Always check with your dealer before adding electrical equipment.

Add-on equipment can drain the vehicle's 12-volt battery, even if the vehicle is not operating.

The vehicle has an airbag system. Before attempting to add anything electrical to the vehicle, see *Servicing the Airbag-Equipped Vehicle* ⇨ 72 and *Adding Equipment to the Airbag-Equipped Vehicle* ⇨ 73.

Vehicle Care

General Information

General Information	203
Accessories and Modifications	203
Lifting the Vehicle	203

Vehicle Checks

Doing Your Own Service Work	206
Bonnet	207
Engine Compartment Overview	208
Engine Oil	211
Engine Oil Life System	216
Automatic Transmission Fluid	217
Manual Gearbox Fluid	217
Hydraulic Clutch	217
Engine Air Cleaner/Filter	218
Cooling System (Engine)	220
Cooling System (Aero Panel)	221
Engine Coolant	222
Engine Overheating	224
Washer Fluid	225
Brakes	226
Brake Fluid	227
Battery	228

Rear Axle	233
Starter Switch Check	234
Automatic Transmission Shift Lock Control Function Check	234
Park Brake and P (Park) Mechanism Check	235
Wiper Blade Replacement	235
Windscreen Replacement	236

Headlamp Aiming

Headlamp Aiming	236
-----------------------	-----

Bulb Replacement

Bulb Replacement	236
High Intensity Discharge (HID) Lighting	236
LED Lighting	237
Number Plate Lamp	237
Replacement Bulbs	237

Electrical System

Electrical System Overload ...	238
Fuses	238
Engine Compartment Fuse Block	238
Rear Compartment Fuse Block	242

Wheels and Tyres

Tyres	245
Winter Tyres	246

Run-Flat Tyres	246
Low-Profile Tyres	247
Competition Oriented Tires ...	248
Summer Tyres	248
Tyre Pressure	249
Tyre Pressure for High-Speed Operation	250
Tyre Pressure Monitor System	251
Tyre Pressure Monitor Operation	252
Tyre Inspection	254
Tyre Rotation	254
When It Is Time for New Tyres	256
Buying New Tyres	256
Different Size Tyres and Wheels	258
Wheel Alignment and Tyre Balance	258
Wheel Replacement	259
Tyre Chains	260
If a Tyre Goes Flat	261
Tyre Sealant and Compressor Kit	262
Storing the Tyre Sealant and Compressor Kit	269

Jump Starting

Jump Starting	269
---------------------	-----

Towing the Vehicle

Towing the Vehicle 272
 Recreational Vehicle
 Towing 273

Appearance Care

Exterior Care 273
 Interior Care 278
 Floor Mats 281

General Information

For service and parts needs, visit your dealer. You will receive genuine parts and trained and supported service people.

Accessories and Modifications

Adding non-dealer accessories or making modifications to the vehicle can affect vehicle performance and safety, including such things as airbags, braking, stability, ride and handling, emissions systems, aerodynamics, durability, and electronic systems like anti-lock brakes, traction control, and stability control. These accessories or modifications could even cause malfunction or damage not covered by the vehicle warranty.

Damage to vehicle components resulting from modifications or the installation or use of non-GM certified parts, including control module or software modifications, is not covered under the terms of the

vehicle warranty and may affect remaining warranty coverage for affected parts.

GM Accessories are designed to complement and function with other systems on the vehicle. See your dealer to accessorise the vehicle using genuine GM Accessories installed by a dealer technician.

Also, see *Adding Equipment to the Airbag-Equipped Vehicle* ⇨ 73.

Lifting the Vehicle

 **Warning**

Lifting a vehicle can cause an injury. The vehicle can slip off the jack and roll over you or other people. You and they could be badly injured. Find a level place to lift your vehicle. To help prevent the vehicle from moving:

1. Apply the parking brake firmly.

(Continued)

Warning (Continued)

- Put an automatic transmission in P (Park) or a manual gearbox in 1 (First) or R (Reverse).

- Turn off the engine.

To be even more certain the vehicle will not move, put chocks in front of and behind the wheels.

Warning

Getting under a vehicle when it is lifted on a jack is dangerous. If the vehicle slips off the jack, you could be badly injured or killed. Never get under a vehicle when it is supported only by a jack.

Warning

Raising the vehicle with the jack improperly positioned can damage the vehicle or the vehicle may fall and cause injury to you or others.

If a jack is used to lift the vehicle, follow the instructions that came with the jack, and be sure to use the correct lifting points to avoid damaging the vehicle.

Caution

Lifting the vehicle improperly can damage it and result in costly repairs not covered by the vehicle warranty. To lift the vehicle properly and prevent vehicle damage:

- Be sure to place a block or pad between the jack and the vehicle.

(Continued)

Caution (Continued)

- Lift only in the areas shown in the following illustrations.

For additional information, see your dealer and the Chevrolet Corvette service manual.

Caution

The front jack pads must not contact the rocker panels, the front fenders, or the floor pan. If they do, damage may occur.

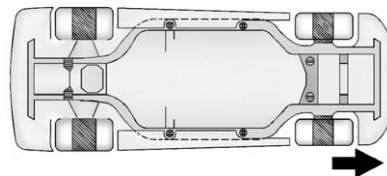

Lifting from the Front – Cradle

The front lifting points can be accessed from either side of the vehicle, behind the front tyres.

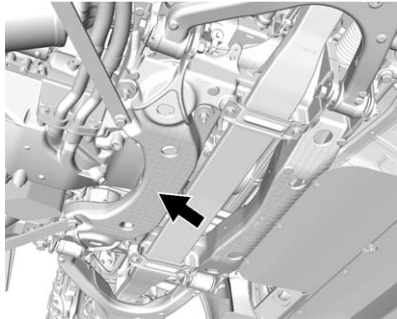

1. Locate the front lifting points.
2. Place a block or pad between the jack and the vehicle.
3. Lift the vehicle with the jack.

Lifting from the Front – Frame

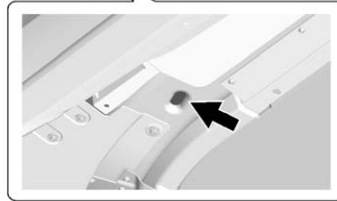

Use only a service jack with a lifting pad diameter of 64 mm (2.5 in) or smaller, and thick enough to make sure the jack does not contact the vehicle body.

Position the service jack and lifting pad under the frame rail shipping slot reinforcement.

Lifting from the Rear – Cradle

The rear lifting points can be accessed from the rear driver or passenger side of the vehicle.

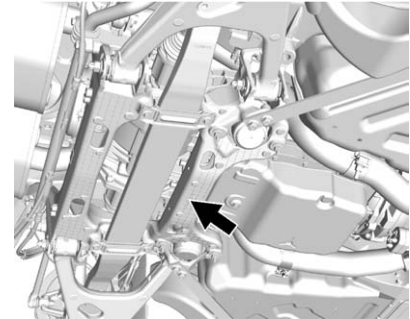

1. Locate the rear lifting points.
2. Place a block or pad between the jack and the vehicle.
3. Lift the vehicle with the jack.

Lifting from the Rear – Frame

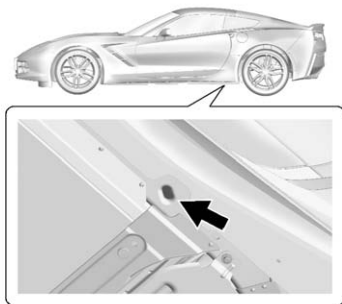

Use only a service jack with a lifting pad diameter of 64 mm (2.5 in) or smaller, and thick enough to make sure the jack does not contact the vehicle body.

Position the service jack and lifting pad under the frame rail shipping slot reinforcement.

For more information, see *Doing Your Own Service Work* ⇨ 206.

Vehicle Checks

Doing Your Own Service Work

Warning

It can be dangerous to work on your vehicle if you do not have the proper knowledge, service manual, tools, or parts. Always follow owner manual procedures and consult the service manual for your vehicle before doing any service work.

If doing some of your own service work, use the proper service manual. It tells you much more about how to service the vehicle than this manual can.

This vehicle has an airbag system. Before attempting to do your own service work, see *Servicing the Airbag-Equipped Vehicle* ⇨ 72.

Keep a record with all parts receipts and list the mileage and the date of any service work performed.

Caution

Even small amounts of contamination can cause damage to vehicle systems. Do not allow contaminants to contact the fluids, reservoir caps, or dipsticks.

Bonnet

To open the bonnet:

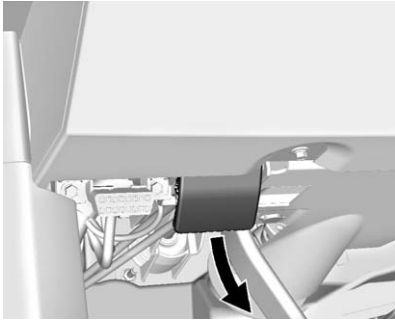

1. Pull the bonnet release lever inside the vehicle. It is below the instrument panel on the driver side.

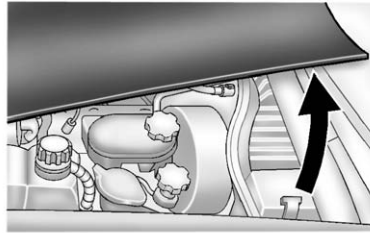

2. Go to the side of the vehicle and pull up on the rear edge of the bonnet, near the windscreen.

Before closing the bonnet, be sure all the filler caps are on properly. Then, pull the bonnet down and close it firmly.

Engine Compartment Overview

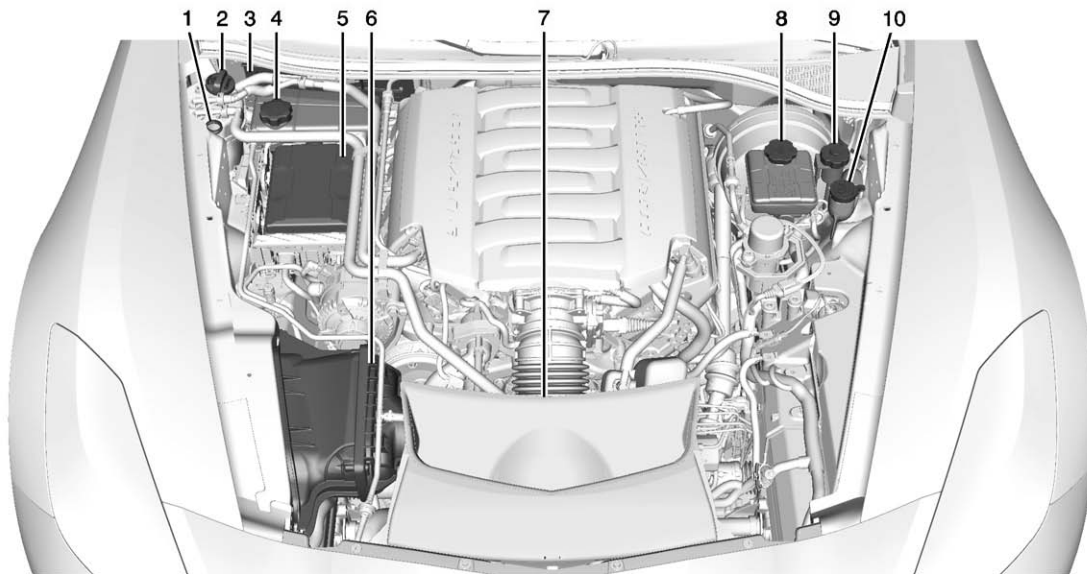

6.2L LT1 V8 Engine (Z51)

- | | | |
|--|---|--|
| <ol style="list-style-type: none"> 1. Engine Oil Dipstick. See "Checking Engine Oil" under <i>Engine Oil</i> ⇨ 211. 2. Dry Sump Engine Oil Tank Fill Cap. See "Changing Engine Oil and Filter" <i>Engine Oil</i> ⇨ 211. 3. <i>Passenger Compartment Air Filter</i> ⇨ 149 (Out of View). 4. Coolant Surge Tank and Pressure Cap. See <i>Engine Coolant</i> ⇨ 222. | <ol style="list-style-type: none"> 5. <i>Engine Compartment Fuse Block</i> ⇨ 238. 6. <i>Engine Air Cleaner/Filter</i> ⇨ 218. 7. Engine Cooling Fan (Out of View). See <i>Cooling System (Engine)</i> ⇨ 220 or <i>Cooling System (Aero Panel)</i> ⇨ 221. 8. Brake Fluid Reservoir. See <i>Brake Fluid</i> ⇨ 227. | <ol style="list-style-type: none"> 9. Clutch Master Cylinder Reservoir (If Equipped). See <i>Hydraulic Clutch</i> ⇨ 217. 10. Windscreen Washer Fluid Reservoir. See "Adding Washer Fluid" under <i>Washer Fluid</i> ⇨ 225. |
|--|---|--|

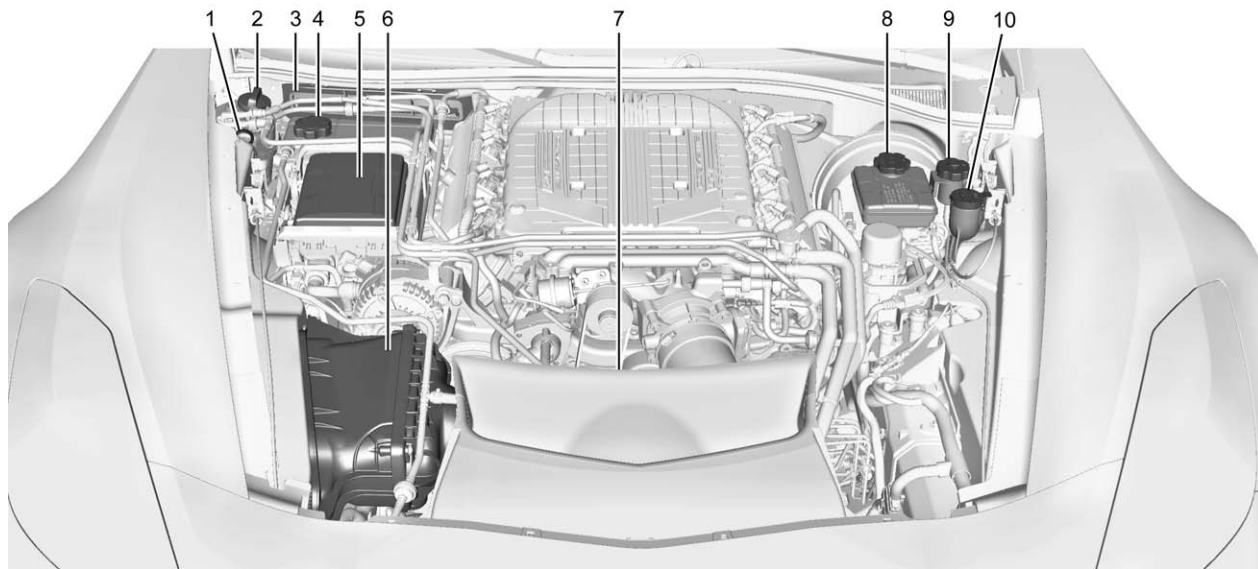

6.2L LT4 V8 Engine (Z06)

1. Engine Oil Dipstick. See "Checking Engine Oil" under *Engine Oil* ⇨ 211.
2. Dry Sump Engine Oil Tank Fill Cap. See "Changing Engine Oil and Filter" *Engine Oil* ⇨ 211.
3. *Passenger Compartment Air Filter* ⇨ 149 (Out of View).
4. Coolant Surge Tank and Pressure Cap. See *Engine Coolant* ⇨ 222.
5. *Engine Compartment Fuse Block* ⇨ 238.
6. *Engine Air Cleaner/Filter* ⇨ 218.
7. Engine Cooling Fan (Out of View). See *Cooling System (Engine)* ⇨ 220 or *Cooling System (Aero Panel)* ⇨ 221.
8. Brake Fluid Reservoir. See *Brake Fluid* ⇨ 227.
9. Clutch Master Cylinder Reservoir (If Equipped). See *Hydraulic Clutch* ⇨ 217.
10. Windscreen Washer Fluid Reservoir. See "Adding Washer Fluid" under *Washer Fluid* ⇨ 225.

Engine Oil

To ensure proper engine performance and long life, careful attention must be paid to engine oil. Following these simple, but important steps will help protect your investment:

- Use engine oil approved to the proper specification and of the proper viscosity grade. See "Selecting the Right Engine Oil" in this section.
- Check the engine oil level regularly and maintain the proper oil level. See "Checking Engine Oil" and "When to Add Engine Oil" in this section.
- Change the engine oil at the appropriate time. See *Engine Oil Life System* ⇨ 216.
- Always dispose of engine oil properly. See "What to Do with Used Oil" in this section.

Checking Engine Oil (Except Stingray with Z51 and Z06)

If the ENGINE OIL LOW - ADD OIL message displays on the Driver Information Centre (DIC), check the engine oil level right away. For more information, see *Engine Oil Messages* ⇨ 120. Check the engine oil level regularly; this is an added reminder.

It is a good idea to check the engine oil level at each fuel fill. In order to get an accurate reading, the vehicle must be on level ground. The engine oil dipstick handle is a loop. See *Engine Compartment Overview* ⇨ 208 for the location of the engine oil dipstick.

Obtaining an accurate oil level reading is essential:

1. If the engine has been running recently, turn off the engine and check within five minutes of shutoff. Checking the oil level too soon after engine shutoff will not provide an accurate oil level reading.

Warning

The engine oil dipstick handle may be hot; it could burn you. Use a towel or glove to touch the dipstick handle.

2. Pull the dipstick and wipe it with a clean paper towel or cloth, then push it back in all the way. Remove it again, keeping the tip down, and check the level.

When to Add Engine Oil (Except Stingray with Z51 and Z06)



If the oil is below the cross-hatched area at the tip of the dipstick, add 1 L (1 qt) of the recommended oil and then recheck the level. See “Selecting the Right Engine Oil” in

this section for an explanation of what kind of oil to use. For engine oil crankcase capacity, see *Capacities and Specifications* ⇨ 291.

See *Track Events and Competitive Driving* ⇨ 154 for additional information on engine oil.

Caution

Do not add too much oil. Oil levels above or below the acceptable operating range shown on the dipstick are harmful to the engine. If you find that you have an oil level above the operating range, i.e., the engine has so much oil that the oil level gets above the cross-hatched area that shows the proper operating range, the engine could be damaged. You should drain out the excess oil or limit driving of the vehicle and seek a service professional to remove the excess amount of oil.

See *Engine Compartment Overview* ⇨ 208 for the location of the engine oil fill cap.

Add enough oil to put the level somewhere in the proper operating range. Push the dipstick all the way back in when done.

Checking Engine Oil (Stingray with Z51 and Z06)

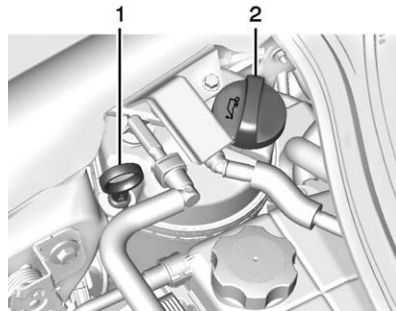

1. Engine Oil Dipstick
2. Engine Oil Fill Cap

It is a good idea to check the engine oil level at each fuel fill. In order to get an accurate reading, the vehicle must be on level ground.

The engine oil dipstick handle is a loop. The dipstick is located on the dry sump engine oil tank. See *Engine Compartment Overview* ⇨ 208 for the location of the dry sump engine oil tank.

These vehicles have a racetrack-ready dry sump engine lubrication system. This high-performance system operates differently than a standard engine lubrication system and requires a special procedure when checking the engine oil level. Follow this procedure closely.

The engine oil level must be checked when the engine is warm. Cold oil level in the dry sump tank may not indicate the actual amount of oil in the system. With this system, engine oil is contained in an external tank, separate from the engine. Under normal operating conditions, the oil pan under the engine does not store any oil. If the vehicle has been parked for an extended period without the engine being started, some oil will seep back into the oil pan, reducing the amount of oil held in the dry sump

tank and there could be no engine oil at all showing on the dipstick. This is normal since the dipstick is designed to read the engine oil level only after the engine has run long enough to reach normal operating temperature. Do not add engine oil based on cold engine dipstick readings. The engine oil level on the dipstick will also be inaccurate if checked while the engine is running.

1. To obtain an accurate engine oil level reading, warm up the engine to at least 80 °C (175 ° F). Cold oil will not give a correct oil level reading.
2. Once the engine is warm, turn off the engine. Checking the oil while the engine is running will result in an incorrect oil level reading.
3. Check the oil level between five and 10 minutes after the engine is shut down.

Warning

The engine oil dipstick handle may be hot; it could burn you. Use a towel or glove to touch the dipstick handle.

4. Remove the dipstick from the external engine oil tank and wipe it with a clean lint-free paper towel or a cloth. Re-insert the dipstick into the external oil tank, pushing it all the way in until it stops.
5. Remove the dipstick from the oil tank and read the level on the cross-hatched area.

When to Add Engine Oil (Stingray with Z51 and Z06)

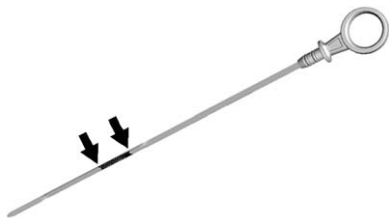

If the oil is below the cross-hatched area at the tip of the dipstick, add 1 L (1 qt) of the recommended oil through the oil fill cap opening in the oil tank and then recheck the level. See “Selecting the Right Engine Oil” for an explanation of what kind of oil to use. For engine oil crankcase capacity, see *Capacities and Specifications* ⇨ 291.

See *Track Events and Competitive Driving* ⇨ 154 for additional information on engine oil.

Caution

Do not add too much oil. Oil levels above or below the acceptable operating range shown on the dipstick are harmful to the engine. If you find that you have an oil level above the operating range, i.e., the engine has so much oil that the oil level gets above the cross-hatched area that shows the proper operating range, the engine could be damaged. You should drain out the excess oil or limit driving of the vehicle and seek a service professional to remove the excess amount of oil.

See *Engine Compartment Overview* ⇨ 208 for the location of the external engine oil tank and fill cap.

Add enough oil to put the level somewhere in the proper operating range. Push the dipstick all the way back into the oil tank when through.

Changing Engine Oil and Filter (Stingray with Z51 and Z06)

The vehicle may have a racetrack-ready dry sump engine lubrication system. This high-performance system operates differently than a standard engine lubrication system and requires a special procedure when changing the engine oil and filter. Follow this procedure closely when changing the engine oil and filter.

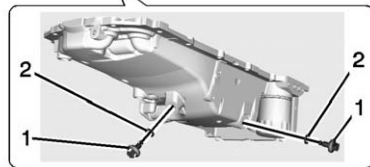

1. Engine Oil Drain Plugs
2. Seals

Steps to follow:

1. Remove the two engine oil drain plugs from the bottom of the engine oil pan. One drain plug drains the external oil tank via the oil transfer supply line. The other drain plug drains residual oil from the crankcase sump. Allow the oil to drain.
2. Once the oil has been drained from the engine, remove the engine oil filter and allow the oil to drain.
3. Reinstall both drain plugs and tighten them to 25 N•m (18 lb ft).
4. Replace the oil filter and tighten it to 30 N•m (22 lb ft). See *Maintenance Replacement Parts* ⇨ 287 for the correct filter.
5. Oil is filled through the opening in the top of the external engine oil tank. Remove the oil fill cap.
6. Add oil to the oil tank. See *Capacities and Specifications* ⇨ 291.

7. Install the oil fill cap and insert the dipstick, if removed.
8. Start the engine and let it run at idle for at least 15 seconds. This will circulate the fresh engine oil through the lubrication system.
9. Shut off the engine and check the oil level as described under “Checking Engine Oil (Stingray with Z51 and Z06).”

Selecting the Right Engine Oil

Selecting the right engine oil depends on both the proper oil specification and viscosity grade. See *Recommended Fluids and Lubricants* ⇨ 286.

Specification



Ask for and use engine oils that meet the dexos2™ specification. Engine oils that have been approved by GM as meeting the dexos2 specification are marked with the dexos2 approved logo.

GM recommends Mobil 1® engine oils that show the dexos approved logo for its dry sump equipped engines.

Use of Substitute Engine Oils if dexos2 is unavailable: In the event that dexos2-approved engine oil is not available at an oil change or for maintaining proper oil level, you may use substitute engine oil that meets ACEA C3 of the appropriate viscosity grade.

Caution

Use only engine oil that is approved to the dexos2 specification or equivalent engine oil as defined in the preceding paragraph. Failure to use the recommended engine oil can result in engine damage not covered by the vehicle warranty.

Viscosity Grade

Use SAE 5W-30 viscosity grade engine oil.

Cold Temperature Operation: In an area of extreme cold, where the temperature falls below -29°C (-20°F), an SAE 0W-30 oil may be used. An oil of this viscosity grade will provide easier cold starting for the engine at extremely low temperatures. When selecting an oil of the appropriate viscosity grade, it is recommended to select an oil of the correct specification. See "Specification" earlier in this section for more information.

For track events or competitive driving, Mobil 1[®] 15W-50 engine oil is recommended. An instrument cluster warning light will be illuminated at high oil temperatures. See *Driver Information Centre (DIC)* ⇨ 111.

Engine Oil Additives/Engine Oil Flushes

Do not add anything to the oil. The recommended oils meeting the dexos2 specification are all that is needed for good performance and engine protection.

Engine oil system flushes are not recommended and could cause engine damage not covered by the vehicle warranty.

What to Do with Used Oil

Used engine oil contains certain elements that can be unhealthy for your skin and could even cause cancer. Do not let used oil stay on your skin for very long. Clean your skin and nails with soap and water, or a good hand cleaner. Wash or properly dispose of clothing or rags containing used engine oil. See the manufacturer's warnings about the use and disposal of oil products.

Used oil can be a threat to the environment. If you change your own oil, be sure to drain all the oil from the filter before disposal. Never dispose of oil by putting it in the

trash or pouring it on the ground, into sewers, or into streams or bodies of water. Recycle it by taking it to a place that collects used oil.

Engine Oil Life System**When to Change Engine Oil**

This vehicle has a computer system that indicates when to change the engine oil and filter. This is based on a combination of factors which include engine revolutions, engine temperature, and miles driven. Based on driving conditions, the mileage at which an oil change is indicated can vary considerably. For the oil life system to work properly, the system must be reset every time the oil is changed.

Z51 and Z06 models have a racetrack-ready dry sump engine lubrication system. This high performance system operates differently than a standard engine lubrication system and requires a special procedure when changing the engine oil and filter. See *Engine Oil* ⇨ 211.

When the system has calculated that oil life has been diminished, it indicates that an oil change is necessary. A CHANGE ENGINE OIL SOON message comes on. See *Engine Oil Messages* ⇨ 120.

Change the oil as soon as possible within the next 1 000 km (600 mi). It is possible that, if driving under the best conditions, the oil life system might indicate that an oil change is not necessary for up to a year. The engine oil and filter must be changed at least once a year and, at this time, the system must be reset. Your dealer has trained service people who will perform this work and reset the system. It is also important to check the oil regularly over the course of an oil drain interval and keep it at the proper level.

Dry Sump Engine Break-In Oil Change

If equipped with a dry sump engine, the initial oil and filter change must be performed at 800 km/500 mi. Follow the engine oil life system for every oil change thereafter.

Resetting the Oil Life System

After you change the oil, the oil life system will need to be reset. See your dealer for service.

If the system is ever reset accidentally, the oil must be changed at 5 000 km (3,000 mi) since the last oil change. Remember to reset the oil life system whenever the oil is changed.

See “Oil Life” under *Driver Information Centre (DIC)* ⇨ 111 for information on the engine oil life system.

Automatic Transmission Fluid

How to Check Automatic Transmission Fluid

It is not necessary to check the transmission fluid level. A transmission fluid leak is the only reason for fluid loss. If a leak occurs, take the vehicle to your dealer and have it repaired as soon as possible.

The vehicle is not equipped with a transmission fluid level dipstick. There is a special procedure for checking and changing the transmission fluid. Because this procedure is difficult, this should be done at the dealer.

Change the fluid and filter at the intervals listed in *Scheduled Maintenance* ⇨ 283, and be sure to use the fluid listed in *Recommended Fluids and Lubricants* ⇨ 286.

Manual Gearbox Fluid

It is not necessary to check the manual gearbox fluid level. A transmission fluid leak is the only reason for fluid loss. If a leak occurs, take the vehicle to the dealer and have it repaired as soon as possible. See *Recommended Fluids and Lubricants* ⇨ 286 for the proper fluid to use.

Hydraulic Clutch

It is not necessary to regularly check clutch fluid unless you suspect there is a leak in the system. Adding fluid will not correct

a leak. A fluid loss in this system could indicate a problem. Have the system inspected and repaired.

When to Check and What to Use



The hydraulic clutch fluid reservoir cap has this symbol on it. See *Engine Compartment Overview* ⇨ 208 for reservoir location.

Refer to the *Recommended Fluids and Lubricants* ⇨ 286 for the proper fluid to use. The fluid requires changing. See the *Scheduled Maintenance* ⇨ 283.

How to Check and Add Fluid

Visually check the clutch fluid reservoir to make sure the fluid level is at the MIN (minimum) line on the side of the reservoir. The hydraulic clutch fluid system should be closed and sealed.

Do not remove the cap to check the fluid level or to top-off the fluid level. Remove the cap only when necessary to add the proper fluid until the level reaches the MIN line.

Engine Air Cleaner/Filter

See *Engine Compartment Overview* ⇨ 208 for the location of the engine air cleaner/filter.

If cleaning the vehicle with the bonnet open, take care not to spray water directly near the filter opening of the air cleaner, as shown in the illustration, as this could damage the vehicle's engine.

When to Inspect the Engine Air Cleaner/Filter

For intervals on changing and inspecting the engine air cleaner/filter, see *Scheduled Maintenance* ⇨ 283.

How to Inspect the Engine Air Cleaner/Filter

Do not start the engine or have the engine running with the engine air cleaner/filter housing open. Before removing the engine air cleaner/

filter, make sure that the engine air cleaner/filter housing and nearby components are free of dirt and debris. Remove the engine air cleaner/filter. Lightly tap and shake the engine air cleaner/filter (away from the vehicle), to release loose dust and dirt. Inspect the engine air cleaner/filter for damage, and replace if damaged. Do not clean the engine air cleaner/filter or components with water or compressed air.

To remove the bonnet extractor duct to gain access:

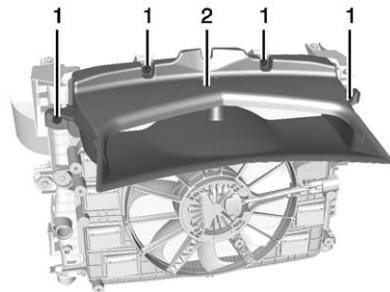

1. Bolts (4)

2. Bonnet Extractor Duct

1. Open the bonnet. See *Bonnet* ⇨ 207.
2. Remove the four bolts (1) and the bonnet extractor duct (2).
3. Reverse Step 2 to replace the bonnet extractor duct.

To inspect or replace the engine air cleaner/filter:

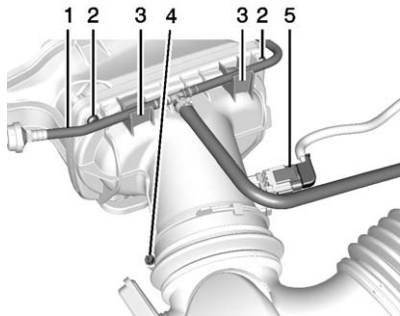

1. Surge Tank Coolant Hose
2. Screws (2)
3. Hose Retainers (2)
4. Air Duct Clamp
5. Electrical Connector

Caution

If the engine coolant surge tank hose is not carefully lifted out of the hose retainers on the air cleaner/filter cover assembly, it may be damaged and cause engine coolant to leak. Damage would not be covered by the vehicle warranty.

1. Carefully lift the surge tank coolant hose (1) from both hose retainers (3) and position the hose to be able to remove the screws securing the air cleaner/filter end cap.
2. Loosen the air duct clamp (4) at the air cleaner/filter housing end cap and move the duct out of the way.
3. Remove the electrical connector (5) from the sensor.
4. Remove the two screws (2).

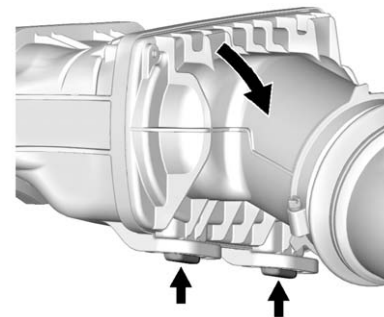

5. Turn the air cleaner/filter end cap downward and disengage the lower end cap mounting tabs from the lower retention hinge features. Be sure to insert the lower end cap mounting tabs fully into the housing retention hinge features before turning the end cap upward and replacing the screws.
6. Inspect or replace the air cleaner/filter.
7. Reverse Steps 1–6 to replace the air cleaner/filter end cap.
8. Replace the extractor bonnet duct. See above.

Warning

Operating the engine with the air cleaner/filter off can cause you or others to be burned. The air cleaner not only cleans the air; it helps to stop flames if the engine backfires. Use caution when working on the engine and do not drive with the air cleaner/filter off.

Caution

If the air cleaner/filter is off, dirt can easily get into the engine, which could damage it. Always have the air cleaner/filter in place when you are driving.

Cooling System (Engine)

The cooling system allows the engine to maintain the correct working temperature.

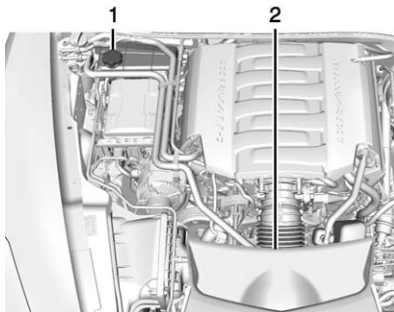
**LT1 Engine (Z51)**

1. Coolant Surge Tank with Pressure Cap
2. Engine Cooling Fan (Out of View)

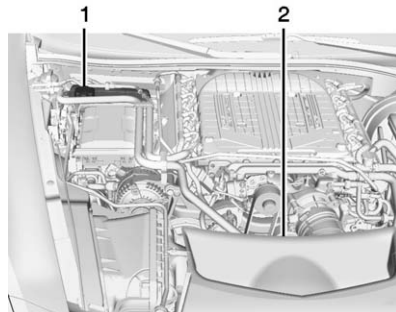
**LT4 Engine (Z06)**

1. Coolant Surge Tank with Pressure Cap
2. Engine Cooling Fan (Out of View)

Warning

An electric engine cooling fan under the bonnet can start up even when the engine is not running and can cause injury. Keep hands, clothing, and tools away from any underbonnet electric fan.

Warning

Heater and radiator hoses, and other engine parts, can be very hot. Do not touch them. If you do, you can be burned.

Do not run the engine if there is a leak. If you run the engine, it could lose all coolant. That could cause an engine fire, and you could be burned. Get any leak fixed before you drive the vehicle.

Caution

Using coolant other than DEX-COOL® can cause premature engine, heater core, or radiator corrosion. In addition, the engine coolant could require changing sooner. Any repairs would not be covered by the vehicle warranty. Always use DEX-COOL (silicate-free) coolant in the vehicle.

Cooling System (Aero Panel)

The aero panel enhances aerodynamic efficiency and improves fuel economy.

Remove the aero panel and bracket to improve engine cooling and air conditioning performance when driving aggressively or in hot weather.

To remove the aero panel and bracket:

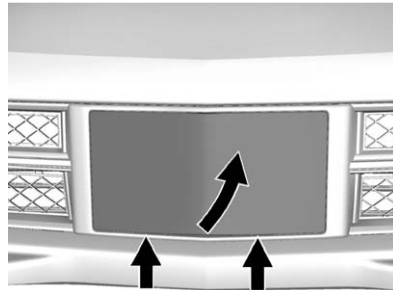

Non-Z51 and Z51 Shown, Z06 Similar

1. Press up on the two indents at the bottom and lift the aero panel off the bracket.

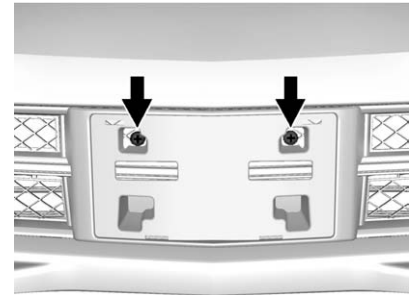

Non-Z51 and Z51 Shown, Z06 Similar

2. Unscrew the two fasteners that secure the bracket.
3. Gently pull the bracket away from the grille.

To replace the bracket and aero panel:

1. Position the bracket over the grille.
2. Secure the bracket by pushing the two fasteners into place.

- Snap the aero panel into place.

Engine Coolant

The cooling system in the vehicle is filled with DEX-COOL[®] engine coolant. See *Recommended Fluids and Lubricants* ⇨ 286. The fluid requires changing at certain intervals. See *Scheduled Maintenance* ⇨ 283.

The following explains the cooling system and how to check and add coolant when it is low. If there is a problem with engine overheating, see *Engine Overheating* ⇨ 224.

What to Use

Warning

Adding only plain water or some other liquid to the cooling system can be dangerous. Plain water and other liquids, can boil before the proper coolant mixture will. The vehicle's coolant warning system is set for the proper coolant mixture. With plain water

(Continued)

Warning (Continued)

or the wrong mixture, the engine could get too hot but you would not get the overheat warning. The engine could catch fire and you or others could be burned. Use a mixture of 40% DEX-COOL coolant and 60% clean, drinkable water.

Use a mixture of 40% DEX-COOL coolant and 60% clean, drinkable water. If using this mixture, nothing else needs to be added. This mixture:

- Gives freezing protection down to -28°C (-18°F), outside temperature.
- Gives boiling protection up to 129°C (265°F), engine temperature.
- Protects against rust and corrosion.
- Will not damage aluminium parts.

- Helps keep the proper engine temperature.

Caution

If improper coolant mixture, inhibitors, or additives are used in the vehicle cooling system, the engine could overheat and be damaged. Too much water in the mixture can freeze and crack engine cooling parts. The repairs would not be covered by the vehicle warranty. Use only the proper mixture of engine coolant for the cooling system. See *Recommended Fluids and Lubricants* ⇨ 286.

Never dispose of engine coolant by putting it in the refuse, pouring it on the ground, or into sewers, streams, or bodies of water. Have the coolant changed by an authorised service centre, familiar with legal requirements regarding used coolant disposal. This will help protect the environment and your health.

If ambient temperatures are anticipated below -28°C (-18°F), make sure a proper mixture ratio of 50% DEXCOOL coolant and 50% clean, drinkable water is used.

Checking Coolant

The vehicle must be on a level surface when checking the coolant level.

Check to see if coolant is visible in the coolant surge tank. If the coolant inside the coolant surge tank is boiling, do not do anything else until it cools down. If coolant is visible but the coolant level is not at or above the cold fill line, add a mixture of 40% DEX-COOL coolant and 60% clean, drinkable water at the coolant recovery tank, but be sure the cooling system is cool before this is done. See *Engine Overheating* ⇨ 224.



The engine coolant surge tank is toward the rear of the engine compartment on the passenger side of the vehicle. See *Engine Compartment Overview* ⇨ 208.

When the engine is cold, the coolant level should be at the cold fill line on the coolant surge tank.

When the engine is hot, the level could be higher than the cold fill line. If the coolant is below the cold fill line when the engine is hot, there could be a leak in the cooling system.

If the coolant is low, add the coolant or take the vehicle to a dealer for service.

How to Add Coolant to the Coolant Surge Tank

Warning

You can be burned if you spill coolant on hot engine parts. Coolant contains ethylene glycol and it will burn if the engine parts are hot enough. Do not spill coolant on a hot engine.

Warning

Steam and scalding liquids from a hot cooling system can blow out and burn you badly. Never turn the cap when the cooling system, including the surge tank pressure cap, is hot. Wait for the cooling system and surge tank pressure cap to cool.

If coolant is needed, add the proper DEX-COOL coolant mixture directly to the surge tank but be sure the cooling system is cool before this is done.

1. When the cooling system, including the coolant surge tank pressure cap and upper radiator hose, is no longer hot, remove the pressure cap.

Turn the pressure cap slowly anticlockwise about one-quarter turn and then stop.

If a hiss is heard, wait for that to stop. A hiss means there is still some pressure left.

2. Keep turning the pressure cap slowly and remove it.
3. Fill the coolant surge tank with the proper DEX-COOL coolant mixture until the level inside stabilises at the cold fill line on the front of the surge tank.
4. With the coolant surge tank pressure cap off, start the engine and let it run until the upper radiator hose can be felt getting hot. Any time during this procedure, watch out for the engine cooling fan.

By this time, the coolant level inside the coolant surge tank may be lower. If the level is lower, add more of the proper mixture to the coolant surge tank until the level stabilises at the cold fill line on the coolant surge tank.

5. Replace the pressure cap tightly.

Check the level in the surge tank when the system has cooled down. If the coolant is not at the proper level, repeat

Steps 1–4, then reinstall the pressure cap. If the coolant is not at the proper level when the system cools down again, see the dealer.

Caution

If the pressure cap is not tightly installed, coolant loss and possible engine damage may occur. Be sure the cap is properly and tightly secured.

Engine Overheating

The vehicle has several indicators to warn of engine overheating.

There is an engine coolant temperature gauge on the instrument cluster. See *Engine Coolant Temperature Gauge* ⇨ 101. The vehicle may also display a message on the Driver Information Centre (DIC). See *Engine Cooling System Messages* ⇨ 119.

If the decision is made not to lift the bonnet but to get service help right away.

If the decision is made to lift the bonnet, make sure the vehicle is parked on a level surface.

Then check to see if the engine cooling fan is running. If the engine is overheating, the fan should be running. If it is not, do not continue to run the engine and have the vehicle serviced.

Caution

Running the engine without coolant may cause damage or a fire. Vehicle damage would not be covered by the vehicle warranty.

If Steam Is Coming from the Engine

Warning

Steam from an overheated engine can burn you badly, even if you just open the bonnet. Stay away from the engine if you see or hear steam coming from it. Just turn it

(Continued)

Warning (Continued)

off and get everyone away from the vehicle until it cools down. Wait until there is no sign of steam or coolant before you open the bonnet.

If you keep driving when the engine is overheated, the liquids in it can catch fire. You or others could be badly burned. Stop the engine if it overheats, and get out of the vehicle until the engine is cool.

If No Steam Is Coming from the Engine

If an engine overheat warning is displayed but no steam can be seen or heard, the problem may not be too serious. Sometimes the engine can get a little too hot when the vehicle:

- Climbs a long hill on a hot day.
- Stops after high-speed driving.
- Idles for long periods in traffic.

If the overheat warning is displayed with no sign of steam:

1. Turn the air conditioning off.
2. Turn the heater on to the highest temperature and to the highest fan speed. Open the windows as necessary.
3. When it is safe to do so, pull off the road, and let the engine idle.

If the temperature overheat gauge is no longer in the shaded area or an overheat warning no longer displays, the vehicle can be driven. Continue to drive the vehicle slowly for about 10 minutes. Keep a safe vehicle distance from the vehicle in front. If the warning does not come back on, continue to drive normally and have the cooling system checked for proper fill and function.

If the warning continues, pull over, stop, and park the vehicle right away.

If there is no sign of steam, idle the engine for three minutes while parked. If the warning is still displayed, turn off the engine until it cools down.

Washer Fluid**What to Use**

When the vehicle needs windscreen washer fluid, be sure to read the manufacturer instructions before use. If the vehicle will be operating in an area where the temperature may fall below freezing, use a fluid that has sufficient protection against freezing.

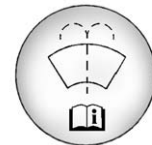
Adding Washer Fluid

Open the cap with the washer symbol on it. Add washer fluid until the tank is full. See *Engine Compartment Overview* ⇨ 208.

Caution

- Do not use washer fluid that contains any type of water repellent coating. This can cause the wiper blades to chatter or skip.
- Do not use engine coolant (antifreeze) in the windscreen washer. It can damage the windscreen washer system and paint.
- Do not mix water with ready-to-use washer fluid. Water can cause the solution to freeze and damage the washer fluid tank and other parts of the washer system.
- When using concentrated washer fluid, follow the manufacturer instructions for adding water.
- Fill the washer fluid tank only three-quarters full when it is very cold. This allows for fluid expansion if

(Continued)

Caution (Continued)

freezing occurs, which could damage the tank if it is completely full.

Brakes

Disc brake pads have built-in wear indicators that make a high-pitched warning sound when the brake pads are worn and new pads are needed. The sound can come and go or be heard all the time the vehicle is moving, except when applying the brake pedal firmly.

 **Warning**

The brake wear warning sound means that soon the brakes will not work well. That could lead to a crash. When the brake wear warning sound is heard, have the vehicle serviced.

Caution

Continuing to drive with worn-out brake pads could result in costly brake repair.

Some driving conditions or climates can cause a brake squeal when the brakes are first applied or lightly applied. This does not mean something is wrong with the brakes.

Properly torqued wheel nuts are necessary to help prevent brake pulsation. When tyres are rotated, inspect brake pads for wear and evenly tighten wheel nuts in the proper sequence to torque specifications in *Capacities and Specifications* ⇨ 291.

Brake linings should always be replaced as complete axle sets.

Brake Pedal Travel

See your dealer if the brake pedal does not return to normal height, or if there is a rapid increase in pedal travel. This could be a sign that brake service may be required.

Replacing Brake System Parts

Always replace brake system parts with new, approved replacement parts. If this is not done, the brakes may not work properly. The braking performance expected can change in many other ways if the wrong replacement brake parts are installed or parts are improperly installed.

Brake Fluid



The brake master cylinder reservoir is filled with DOT 3 brake fluid as indicated on the reservoir cap. See *Engine Compartment Overview* ⇨ 208 for the location of the reservoir.

There are only two reasons why the brake fluid level in the reservoir may go down:

- Normal brake lining wear. When new linings are installed, the fluid level goes back up.
- A fluid leak in the brake hydraulic system. Have the brake hydraulic system fixed. With a leak, the brakes will not work well.

Always clean the brake fluid reservoir cap and the area around the cap before removing it.

Do not top off the brake fluid. Adding fluid does not correct a leak. If fluid is added when the linings are worn, there will be too much fluid when new brake linings are installed. Add or remove fluid, as necessary, only when work is done on the brake hydraulic system.

Warning

If too much brake fluid is added, it can spill on the engine and burn, if the engine is hot enough. You or others could be burned, and the vehicle could be damaged. Add brake fluid only when work is done on the brake hydraulic system.

When the brake fluid falls to a low level, the brake warning light comes on. See *Brake System Warning Light* ⇨ 105.

Brake fluid absorbs water over time. Replace brake fluid at the specified intervals to prevent increased stopping distance. See *Scheduled Maintenance* ⇨ 283.

What to Add

Use only GM approved DOT 3 brake fluid from a clean, sealed container. See *Recommended Fluids and Lubricants* ⇨ 286.

 **Warning**

The wrong or contaminated brake fluid could result in damage to the brake system. This could result in the loss of braking leading to a possible injury. Always use the proper brake fluid.

Caution

If brake fluid is spilled on the vehicle's painted surfaces, the paint finish can be damaged. Immediately wash off any painted surface.

Battery

The original equipment battery is maintenance free. Do not remove the cap and do not add fluid.

Refer to the replacement number on the original battery label when a new battery is needed.

For battery replacement, see your dealer or the service manual.

 **Warning**

Batteries should not be disposed of with regular refuse. Make sure that you dispose of old batteries in accordance with environmental protection regulations to help protect the environment and your health.

 **Warning**

Do not use a match or flame near a vehicle's battery. If you need more light, use a torch.

Do not smoke near a vehicle's battery.

When working around a vehicle's battery, shield your eyes with protective glasses.

Keep children away from vehicle batteries.

 **Warning**

Batteries have acid that can burn you and gas that can explode. You can be hurt badly if you are not careful.

Follow instructions carefully when working around a battery.

Battery posts, terminals and related accessories contain lead and lead compounds which can cause cancer and reproductive harm. Wash hands after handling.

Vehicle Storage



Some vehicles have a battery maintainer package. Follow the instructions provided with the battery maintainer package to keep the battery charged when the vehicle is not in use. Plug the battery maintainer into the rear accessory power outlet only. The front power outlet turns off after the ignition is off.

For vehicles without a battery maintainer, see the following information.

Infrequent Usage: Remove the black, negative (-) cable from the battery to keep the battery from running down.

See “Window Indexing” in *Power Windows* ⇨ 41.

Extended Storage: It is recommended that the battery maintainer package be used. However, if not, remove the black, negative (-) cable from the battery. All vehicle memory settings will need to be reset when battery power is restored.

Battery Charger/Maintainer

For lead-acid batteries up to 120 Ah

INTRODUCTION

Please read and follow the instructions carefully.

SAFETY

- The charger is designed for charging 12V lead-acid batteries. Do not use the charger for any other purpose.

- Battery acid is corrosive. Rinse immediately with water if acid comes into contact with skin or eyes and seek immediate medical advice.
- Ensure that the cabling lies straight and does not come into contact with hot surfaces or sharp edges.
- A charging battery could emit explosive gases, which is why it is important to prevent sparks close to the battery. When batteries are reaching the end of their life cycle, internal sparks may occur.
- Always provide for proper ventilation during charging.
- Avoid covering the charger.
- Ensure that the mains cable is not exposed to water.
- Never charge a frozen battery.
- Never charge a damaged battery.
- Never place the charger on top of the battery when charging.



- Connection to the mains supply must be in accordance with the national regulations for electrical installations.
- Check the charger cables prior to use. Ensure that no cracks have occurred in the cables or in the bend protection. A charger with damaged cables must not be used.
- Always check that the charger has switched to maintenance charging mode before leaving the charger unattended and connected for long periods. If the charger has not switched to maintenance charging within 72 hours, this is an indication of an error. In such cases the charger must be disconnected manually.

- If a battery fails during charging, the charger's advanced technology will take care of most problems but some rare errors in the battery could still exist. Don't leave a battery connected to the charger unattended for a longer period of time.
- Store and use the battery charger out of the reach of children and ensure that children cannot play with the charger.
- Batteries consume water during use and charging. For batteries where water can be added, the water level should be checked regularly. If the water level is low add distilled water.

BATTERY TYPES AND SETTINGS

The charger is suitable for use with the battery supplied in your vehicle. If you replace the original battery, observe the battery manufacturer's guidelines. See which battery sizes that the various charger models are suitable for under "TECHNICAL SPECIFICATIONS."

The table explains the various lamps:

	<p>In error mode, the charger cuts the charging/voltage supply. The charger goes to error mode in the following circumstances: - If the battery has been connected with reverse polarity to the charger terminals. - The charger terminals are short circuited.</p>
	Bulk charging
	Maintenance charging

CHARGING

Connection of the charger to batteries that are fitted in vehicles:

1. Connecting the XS 3600 Corvette (model XS 3600)
 - Connecting the equipment to a battery fitted in the vehicle.
2. When the rear accessory power outlet is being connected or disconnected, the plug of the XS 3600 Corvette (model XS 3600) must be disconnected from the power socket.

3. Connect charger to the rear APO.
4. Connect the AC cord to the wall socket.

START CHARGING

1. After the APO has been connected to the vehicle, connect the charger to the wall socket.
2. XS 3600 Corvette (model XS 3600) starts charging as soon as the mains supply is connected.
3. Normal charging will be indicated by the lamp for bulk charge or the lamp for maintenance charge. When the lamp for maintenance charge is lit, it means that the battery is fully charged. The charge will restart again if the voltage drops.
4. Charging can be stopped at any time by disconnecting the mains supply. Always disconnect the cable from the wall socket before disconnecting the APO.

5. If the charging lamp and the maintenance charger lamp are flashing alternately:
 If the lamps are flashing a few times per second this could be due to a poor contact between the charger and the battery or that the battery is sulphated. Check the connection to the battery. If the lamps flash for more than 60 minutes, this indicates that the battery is damaged and needs to be replaced. If the lamps flash at a few minute intervals, the battery has a high self discharge and may need replacing.

CHARGING STEPS

The charger has a four step, fully automatic charging cycle. At the start of charging, the battery charger delivers maximum current to the battery and the battery voltage increases steadily to maximum voltage. At this point the voltage will be regulated and held at a constant level by the charging current, then dropping gradually. When the

charging current has dropped below 0.4A, the charger switches to maintenance charging.

If the battery is loaded and the battery voltage drops to 12.9V, the charger automatically reverts to the start of the charging cycle.

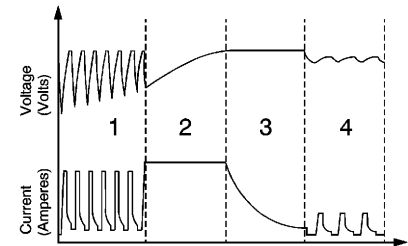

Charging steps:

- 1) Desulphation :** Desulphation with pulses for sulphated batteries.
- 2) Bulk :** Main charging where around 80% of the charge takes place. The charge is carried out at constant charge until full voltage has reached the set level.

3) Absorption : Final part of the charge up to almost 100%. The terminal voltage is kept constant at a set level. During this step the charge current falls gradually to ensure the terminal voltage does not get too high. If the absorption phase has been in progress for more than 12 hours, the charger will switch to maintenance charging. This feature protects against damage if a problem is detected in the battery.

4) Pulse : Maintenance charging. The state of charge is between 95% and 100%. The battery receives a pulse when the voltage drops. This keeps the battery in trim when not in use. The charger could be connected for months at a time. Check the water level in the battery if possible.

TECHNICAL SPECIFICATIONS

Charger model	XS 3600
Rated Voltage AC	220—240VAC, 50—60Hz
Charging voltage	14.4V

Min battery voltage	2V
Charging current	3.6A max
Current, mains	0.6A rms
Back current drain*	< 1Ah/month
Ripple**	Max 50mV rms, max 130mA
Ambient temperature	-20°C to +50°C, output power is reduced automatically at higher temperatures***
Cooling	Natural convection
Charger type	4 step, fully automatic charging cycle
Battery types	All types of 12V lead-acid batteries (Wet, Ca/Ca, MF, VRLA, AGM and GEL)
Battery capacity	14—120Ah

Dimensions	142 x 51 x 36mm (L x W x H)
Insulation class	IP65****
Weight	0.5kg
Plug:	CEE 7/4, TYPE F, not grounded*****

*) Back current drain is the current that drains the battery if the charger is not connected to the mains. The XS 3600 Corvette charger has a very low back current.

**) The quality of the charging voltage and charging current is very important. A high current ripple heats up the battery which has an ageing effect on the positive electrode. High voltage ripple could harm other equipment that is connected to the batteries. The XS 3600 Corvette battery charger produce very clean voltage and current with very low ripple.

***) Only for indoor use in Finland: 0°C to +50°C applies.

****) If connection to the mains is by the flat Euro connector, the battery charger has the IP63 insulation class except for in Switzerland where IP65 applies.

*****) For Switzerland and United Kingdom an adapter is required.

TEMPERATURE PROTECTION

The charger is protected against overheating. The power is reduced when the ambient temperature increases.

The charger may be perceived as being hot during charging. This is completely normal, although you should avoid placing it on a sensitive surface.

MAINTENANCE

The charger is maintenance free. Please note that dismantling the charger is not permitted and will void the warranty. A defective mains cable must be replaced. Keep your charger clean.

Wipe it with a soft tissue and mild cleaning liquid. The charger must be disconnected before cleaning.

BATTERY CABLES

The XS 3600 Corvette (model XS 3600) is equipped with an accessory power outlet for connecting to the vehicle.

BULK CHARGING TIME

The table shows the duration of the Bulk step-up to about 80% state of charge.

Battery size (Ah)	Time (h)
70	17

Rear Axle

When to Check Lubricant

It is not necessary to regularly check rear axle fluid unless a leak is suspected or an unusual noise is heard. A fluid loss could indicate a problem. Have it inspected and repaired.

How to Check Lubricant

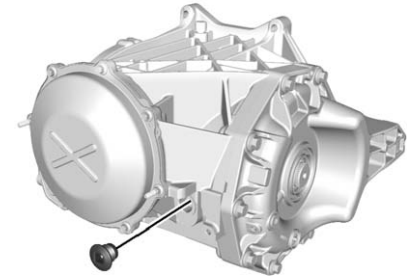

To get an accurate reading, the vehicle should be on a level surface.

The fluid level should be at or within 13 mm (0.5 in) of the bottom of the fill plug hole threads. If it is at this level, no additional fluid is needed. If the fluid level is below 13 mm (0.5 in), add fluid until it is above this level.

What to Use

To add lubricant when the level is low or to completely refill after draining, see *Recommended Fluids and Lubricants* ⇨ 286. Then fill to within 13 mm (0.5 in) of the bottom of the fill plug hole threads with the required lubricant.

Starter Switch Check

Warning

When you are doing this inspection, the vehicle could move suddenly. If the vehicle moves, you or others could be injured.

1. Before starting this check, be sure there is enough room around the vehicle.
2. Firmly apply both the parking brake and the regular brake. See *Electric Parking Brake* ⇨ 182.

Do not use the accelerator pedal, and be ready to turn off the engine immediately if it starts.

3. For automatic transmission vehicles, try to start the engine in each gear. The vehicle should start only in P (Park) or N (Neutral). If the vehicle starts in any other position, contact your dealer for service.

For manual gearbox vehicles, put the shift lever in Neutral, push the clutch pedal down halfway and try to start the engine. The vehicle should start only when the clutch pedal is pushed down all the way to the floor. If the vehicle starts when the clutch pedal is not pushed all the way down, contact your dealer for service.

Automatic Transmission Shift Lock Control Function Check

Warning

When you are doing this inspection, the vehicle could move suddenly. If the vehicle moves, you or others could be injured.

1. Before starting this check, be sure there is enough room around the vehicle. It should be parked on a level surface.
2. Apply the parking brake. See *Electric Parking Brake* ⇨ 182.
Be ready to apply the regular brake immediately if the vehicle begins to move.
3. With the engine off, turn the ignition on, but do not start the engine. Without applying the regular brake, try to move the gear lever out of P (Park) with

normal effort. If the shift lever moves out of P (Park), contact your dealer for service.

Park Brake and P (Park) Mechanism Check

Warning

When you are doing this check, the vehicle could begin to move. You or others could be injured and property could be damaged. Make sure there is room in front of the vehicle in case it begins to roll. Be ready to apply the regular brake at once should the vehicle begin to move.

Park on a fairly steep hill, with the vehicle facing downhill. Keeping your foot on the regular brake, apply the parking brake.

- To check the parking brake's holding ability: With the engine running and the transmission in N (Neutral), slowly remove foot

pressure from the regular brake pedal. Do this until the vehicle is held by the parking brake only.

- To check the P (Park) mechanism's holding ability: With the engine running, shift to P (Park). Then release the parking brake followed by the regular brake.

Contact your dealer if service is required.

Wiper Blade Replacement

Windscreen wiper blades should be inspected for wear and cracking.

Replacement blades come in different types and are removed in different ways. For proper type and length, see *Maintenance Replacement Parts* ⇨ 287.

To replace the windscreen wiper blade:

1. Open the bonnet.
2. Pull the windscreen wiper assembly away from the windscreen.

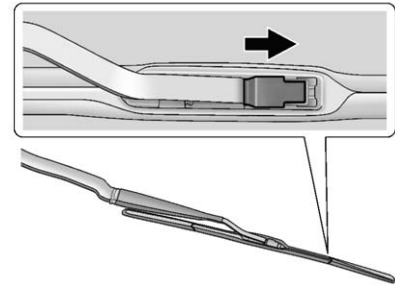

3. Lift up on the latch in the middle of the wiper blade where the wiper arm attaches.
4. With the catch open, pull the wiper blade down towards the windscreen far enough to release it from the J-hooked end of the wiper arm.
5. Remove the wiper blade.

Allowing the wiper blade arm to touch the windscreen when no wiper blade is installed could damage the windscreen. Any damage that occurs would not be covered by the vehicle

warranty. Do not allow the wiper blade arm to touch the windshield.

- Reverse Steps 1–3 for wiper blade replacement.

Windscreen Replacement

The windscreen is part of the HUD system. If the vehicle has to have the windscreen replaced, get one that is designed for HUD or the HUD image may look out of focus.

Headlamp Aiming

Headlamp alignment has been preset and should need no further adjustment.

If the vehicle is damaged in a crash, the headlamp alignment may be affected. If adjustment to the headlamps is necessary, see your dealer.

Bulb Replacement

For the proper type of replacement bulbs, see *Replacement Bulbs* ⇨ 237.

For any bulb-changing procedure not listed in this section, contact your dealer.

High Intensity Discharge (HID) Lighting



The high intensity discharge lighting system operates at a very high voltage. If you try to service any of the system components, you could be seriously injured. Have your dealer or a qualified technician service them.

After an HID headlamp bulb has been replaced, the beam might be a slightly different shade than it was originally. This is normal.

LED Lighting

This vehicle has several LED lamps. For replacement of any LED lighting assembly, contact your dealer.

Number Plate Lamp

To replace one of these bulbs:

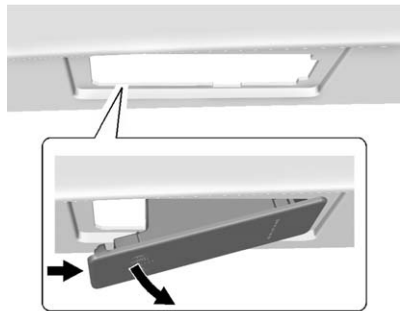

Passenger Side Shown, Driver Side Similar

1. Push the lamp assembly toward the right.
2. Pull the lamp assembly down to remove.

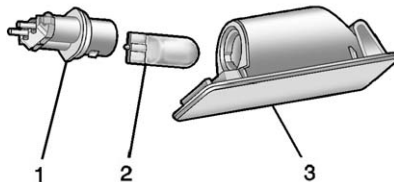

3. Turn the bulb socket (1) anticlockwise to remove it from the lamp assembly (3).
4. Pull the bulb (2) straight out of the bulb socket.
5. Push the replacement bulb straight into the bulb socket and turn the bulb socket clockwise to install it into the lamp assembly.
6. Push the lamp assembly back into position until the release tab locks into place.

Replacement Bulbs

Exterior Lamp	Bulb Number
Number Plate Lamp	W5W LL

For replacement bulbs not listed here, contact your dealer.

Electrical System

Electrical System Overload

The vehicle has fuses to protect against an electrical system overload. Fuses also protect power devices in the vehicle.

Replace a bad fuse with a new one of the identical size and rating.

If there is a problem on the road and a fuse needs to be replaced, there are some spare fuses and a fuse puller in the Instrument Panel Fuse Block. The same amperage fuse can also be borrowed. Choose some feature of the vehicle that is not needed to use and replace it as soon as possible.

Windscreen Wipers

If the wiper motor overheats due to heavy snow or ice, the windscreen wipers will stop until the motor cools and will then restart.

Although the circuit is protected from electrical overload, overload due to heavy snow or ice may

cause wiper linkage damage. Always clear ice and heavy snow from the windscreen before using the windscreen wipers.

If the overload is caused by an electrical problem and not snow or ice, be sure to get it fixed.

Fuses

The wiring circuits in the vehicle are protected from short circuits by fuses. This greatly reduces the chance of fires caused by electrical problems.

Look at the silver-coloured band inside the fuse. If the band is broken or melted, replace the fuse. Be sure you replace a bad fuse with a new one of the identical size and rating.

Fuses of the same amperage can be temporarily borrowed from another fuse location, if a fuse goes out. Replace the fuse as soon as you can.

Engine Compartment Fuse Block

There is one fuse block in the engine compartment on the passenger side of the vehicle. See *Engine Compartment Overview* ⇨ 208 for more information on location.

Caution

Spilling liquid on any electrical component on the vehicle may damage it. Always keep the covers on any electrical component.

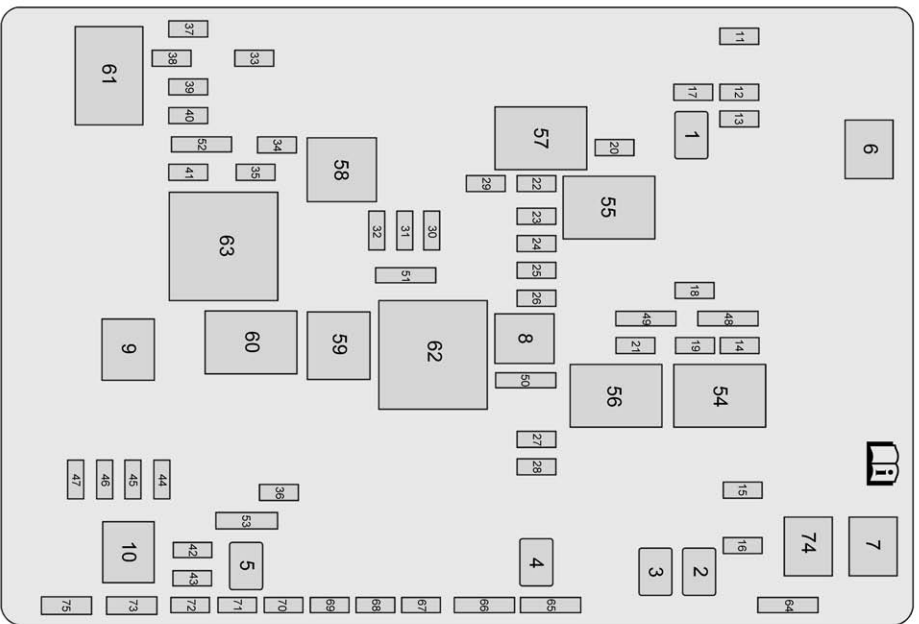

240 Vehicle Care

The vehicle may not be equipped with all of the fuses, relays, and features shown.

Micro J-Case Fuses	Usage
1	Front Wiper
2	Starter
3	Anti-locking Brake System Valves
4	Engine Control Module
5	Electric Parking Brake

J-Case Fuses	Usage
6	Front Heater, Ventilation, and Air Conditioning
7	Antilock Brake System Pump
8	Logistics
9	Vacuum Pump

J-Case Fuses	Usage
10	Electronic Rear Differential Module
74	Transmission Cooling Fan 2

Micro Fuses 2-pin	Usage
11	Heated Seat 1
12	Column Lock Module
13	Steering Column
14	Glove Box
15	Engine Inside Position
16	Body Control Module 6
17	Heater, Ventilation, and Air Conditioning Controls
18	Body Control Module 5

Micro Fuses 2-pin	Usage
19	Heated Seat 2
20	Body Control Module 7
21	Electric Steering Column Lock
22	Display
23	Auxiliary Outlet
24	Radio
25	Instrument Cluster HUD
26	Inside Rearview Mirror
27	Odd Ignition
28	Even Ignition
29	Data Link Connector
30	Seat Fan
31	Fuel Pump Power Module
32	Exhaust Valve 1
33	Horn

Micro Fuses 2-pin	Usage
34	Headlamp Washer
35	Air Conditioning Compressor Clutch
36	Engine Outside Position
37	Real Time Damping
38	Intercooler
39	Left Headlamp
40	Right Headlamp
41	Headlamp Washer Pump
42	Exhaust Valve 2
43	Reverse Lockout
44	Electric Rear Differential Module
45	Rear Transmission Cooler Fan

Micro Fuses 2-pin	Usage
46	Transmission Control Module
47	Canister Vent

Micro Fuses 3-pin	Usage
48	Integrated Chassis Control Module/ Automatic Occupant Sensing
49	Theft/Vehicle Interface Module
50	Engine/ Transmission
51	Instrument Cluster
52	Headlamp High Beam
53	Transmission Control Module/ Engine Control Module

Micro Relays	Usage
54	Starter
55	Front Wiper Low/High
56	Run/Crank
57	Front Wiper Motor
58	Headlamp Washer
59	Air Conditioning Control
60	Logistics 1
61	Headlamp Low

Mini Relays	Usage
62	Engine Control Module
63	Vacuum Pump

SPARE FUSES	Usage
64	Spare
65	Spare
66	Spare
67	Spare
68	Spare
69	Spare
70	Spare
71	Spare
72	Spare
73	Spare
75	Spare

Rear Compartment Fuse Block

The rear compartment fuse block is in the rear of the vehicle, under the load floor. Lift the carpet and access door in the centre of the load floor to access the fuses.

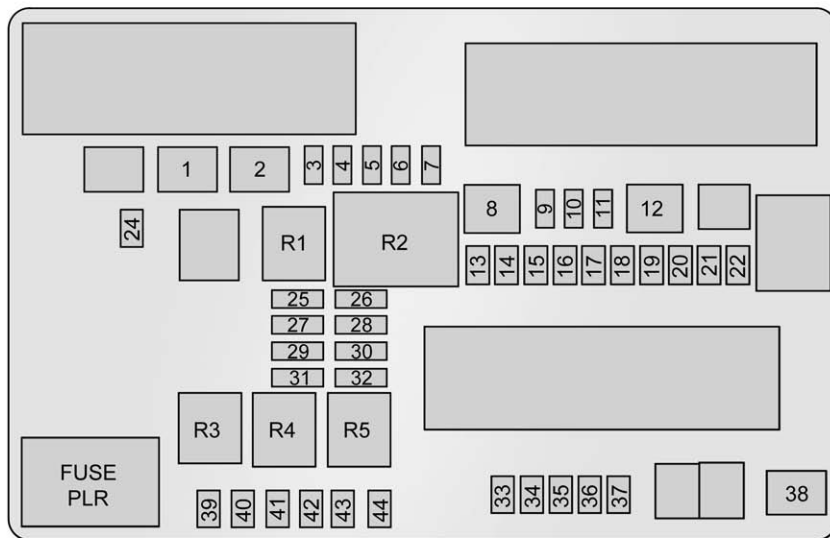

244 Vehicle Care

You can remove fuses using the fuse puller.

The vehicle may not be equipped with all of the fuses, relays, and features shown.

Fuses	Usage
1	Window
2	Driver Power Seat
3	PEPS 2
4	PEPS 1
5	Engine Control Module
6	Heated Mirrors
7	Body Control Module 4
8	Rear Window Demister
9	GBS
10	Body Control Module 2
11	Steering Wheel
12	Passenger Power Seat

Fuses	Usage
13	Not Used
14	Outside Rearview Mirror
15	Body Control Module 1
16	Body Control Module 3
17	Sensing Diagnostic Module/Automatic Occupant Sensing
18	Logistics 2
19	Body Control Module 8
20	Integrated Chassis Control Module
21	Amplifier
22	Rear Accessory Power Outlet
24	Memory Seat Module/ Convertible Top
25	Theft-Deterrent PSM

Fuses	Usage
26	LCM
27	OnStar (If Equipped)
28	Camera Module
29	Not Used
30	Fuel Pump Power Module
31	LCM Cinch Latch
32	Battery Regulated Voltage Control
33	Not Used
34	Convertible Top Solenoid
35	Not Used
36	Passenger Window Switch
37	Front Accessory Power Outlet
38	Not Used
39	Spare
40	Spare

Fuses	Usage
41	Spare
42	Spare
43	Spare
44	Spare

Relays	Usage
R1	Logistics 2
R2	Rear Window Demister
R3	Not Used
R4	Front Accessory Power Outlet
R5	Theft (Door Lock Security)

Wheels and Tyres

Tyres

Every new GM vehicle has high-quality tyres made by a leading tyre manufacturer. See the warranty manual for information regarding the tyre warranty and where to get service. For additional information refer to the tyre manufacturer.

Warning

- Poorly maintained and improperly used tyres are dangerous.
- Overloading the tyres can cause overheating as a result of too much flexing. There could be a blowout and a serious crash. See *Vehicle Load Limits* ⇨ 162.

(Continued)

Warning (Continued)

- Underinflated tyres pose the same danger as overloaded tyres. The resulting crash could cause serious injury. Check all tyres frequently to maintain the recommended pressure. Tyre pressure should be checked when the tyres are cold.
- Overinflated tyres are more likely to be cut, punctured, or broken by a sudden impact - such as when hitting a pothole. Keep tyres at the recommended pressure.
- Worn or old tyres can cause a crash. If the tread is badly worn, replace them.

(Continued)

Warning (Continued)

- Replace any tyres that have been damaged by impacts with potholes, curbs, etc.
- Improperly repaired tyres can cause a crash. Only the dealer or an authorised tyre service centre should repair, replace, dismount, and mount the tyres.
- Do not spin the tyres in excess of 56 km/h (35 mph) on slippery surfaces such as snow, mud, ice, etc. Excessive spinning may cause the tyres to explode.

See *Tyre Pressure for High-Speed Operation* ⇨ 250 for inflation pressure adjustment for high-speed driving.

Winter Tyres

This vehicle was not originally equipped with winter tyres. Winter tyres are designed for increased traction on snow and ice-covered roads. Consider installing winter tyres on the vehicle if frequent driving on ice or snow covered roads is expected. See your dealer for details regarding winter tyre availability and proper tyre selection. Also, see *Buying New Tyres* ⇨ 256.

With winter tyres, there may be decreased dry road traction, increased road noise and shorter tread life. After changing to winter tyres, be alert for changes in the vehicle handling and braking.

If using winter tyres:

- Use tyres of the same brand and tread type on all four wheel positions.
- Use only radial ply tyres of the same size, load range and speed rating as the original equipment tyres.

Winter tyres with the same speed rating as the original equipment tyres may not be available for H, V, W, Y and ZR speed rated tyres. If winter tyres with a lower speed rating are chosen, never exceed the tyre's maximum speed capability.

Run-Flat Tyres

This vehicle, when new, had run-flat tyres. There is no spare tyre, no tyre changing equipment and no place to store a tyre in the vehicle.

The vehicle also has a Tyre Pressure Monitor System (TPMS) that indicates a loss of tyre pressure in any of the tyres.

 **Warning**

If the low tyre warning light displays on the instrument cluster, the handling capabilities will be reduced during severe manoeuvres. Driving too fast could cause loss of control and you or others could be injured. Do

(Continued)

Warning (Continued)

not drive over 80 km/h (50 mph) when the low tyre warning light is displayed. Drive cautiously and check the tyre pressures as soon as possible.

Run-flat tyres can be driven on with no air pressure. There is no need to stop on the side of the road to change the tyre. Continue driving; however, do not drive too far or too fast. Driving on the tyre may not be possible if there is permanent damage. To prevent permanent damage, the tyre can be driven with no air pressure for up to 80 km (50 mi) at speeds slower than 80 km/h (50 mph). As soon as possible, contact the nearest authorised GM or run-flat servicing facility for inspection and repair or replacement.

When driving on a deflated run-flat tyre, avoid potholes and other road hazards that could damage the tyre and/or wheel beyond repair. When a tyre has been damaged, or if driven

any distance while deflated, check with an authorised run-flat tyre service centre to determine whether the tyre can be repaired or should be replaced. To maintain the run-flat feature, all replacement tyres must be run-flat tyres.

To locate the nearest GM or run-flat servicing facility, call Customer Assistance.

The valve stems on run-flat tyres have sensors that are part of the TPMS. See *Tyre Pressure Monitor System* ⇨ 251. These sensors contain batteries that are designed to last for 10 years under normal driving conditions. See your dealer for wheel or sensor replacement.

Caution

Using liquid sealants can damage the tyre valves and tyre pressure monitor sensors in the run-flat tyres. This damage is not covered by the vehicle warranty. Do not use liquid sealants in run-flat tyres.

Low-Profile Tyres**Low-Profile Performance Tyre**

The original equipment tyres on this vehicle are classified as low-profile performance tyres. These tyres are designed for very responsive driving on wet or dry metalled roads, however, may produce more road noise and tend to wear faster.

Caution

Low-profile tyres are more susceptible to damage from road hazards or curb impact than standard profile tyres. Tyre and/or wheel assembly damage can occur when coming into contact with road hazards like potholes, or sharp edged objects, or when sliding into a kerb. The warranty does not cover this type of damage. Keep tyres set to the correct inflation pressure and

(Continued)

Caution (Continued)

when possible, avoid contact with kerbs, potholes, and other road hazards.

Competition Oriented Tires

This vehicle may come with P285/30ZR19 and P335/25ZR20 Michelin PS CUP2 competition oriented tires that are DOT approved for street use. Competition oriented tires use a special tread pattern and compound that provide more grip than normal road tires. The minimum tread depth will be reached earlier than typical tyres, resulting in reduced tyre life. This special tread pattern and compound will have decreased performance in cold climates, heavy rain, and standing water. It is recommended that winter tires be installed on the vehicle when driving at temperatures below approximately

10 °C (50 °F) or on ice or snow covered roads. See *Winter Tyres* ⇨ 246.

Warning

Driving on wet roads, in heavy rain, or through standing water with competition oriented tires may cause hydroplaning and loss of control. Use extreme caution and drive slowly on wet roads.

Warning

Driving with competition oriented tires on snow, ice, or cold road surfaces can cause loss of control or an accident. Competition oriented tires are summer season tires and are not intended to be driven on snow, ice, or road surfaces below 10 °C (50 °F). Do not drive a vehicle with competition oriented tires in these conditions.

Caution

Competition oriented tires have rubber compounds that lose flexibility and may develop surface cracks in the tread area at temperatures below -7 °C (20 °F). Always store competition oriented tires indoors and at temperatures above -7 °C (20 °F) when not in use. If the tires have been subjected to -7 °C (20 °F) or less, let them warm up in a heated space to at least 10 °C (50 °F) for 24 hours or more before being installed or driving a vehicle on which they are installed. Do not apply heat or blow heated air directly on the tyres. Always inspect tyres before use. See *Tyre Inspection* ⇨ 254.

Summer Tyres**High Performance Summer Tyres**

This vehicle may come with high performance summer tyres. These tyres have a special tread and

compound that are optimised for maximum dry and wet road performance. This special tread and compound will have decreased performance in cold climates, and on ice and snow. It is recommended that winter tyres be installed on the vehicle if frequent driving at temperatures below approximately 5 °C (40 °F) or on ice or snow covered roads is expected. See *Winter Tyres* ⇨ 246.

Caution
<p>High performance summer tires have rubber compounds that lose flexibility and may develop surface cracks in the tread area at temperatures below -7 °C (20 °F). Always store high performance summer tires indoors and at temperatures above -7 °C (20 °F) when not in use. If the tires have been subjected to -7 °C (20 °F) or less, let them warm up in a heated space to at least 5 °C (40 °F) for</p> <p style="text-align: right;">(Continued)</p>

Caution (Continued)
<p>24 hours or more before being installed or driving a vehicle on which they are installed. Do not apply heat or blow heated air directly on the tyres. Always inspect tyres before use. See <i>Tyre Inspection</i> ⇨ 254.</p>

Tyre Pressure

Tyres need the correct amount of air pressure to operate effectively.

Caution
<p>Neither tyre underinflation nor overinflation is good. Underinflated tyres, or tyres that do not have enough air, can result in:</p> <ul style="list-style-type: none"> • Tyre overloading and overheating which could lead to a blowout. <p style="text-align: right;">(Continued)</p>

Caution (Continued)
<ul style="list-style-type: none"> • Premature or irregular wear. • Poor handling. • Reduced fuel economy. <p>Overinflated tyres, or tyres that have too much air, can result in:</p> <ul style="list-style-type: none"> • Unusual wear. • Poor handling. • Rough ride. • Needless damage from road hazards.

The Tyre and Loading Information label on the vehicle indicates the original equipment tyres and the correct cold tyre inflation pressures. The recommended pressure is the minimum air pressure needed to

support the vehicle's maximum load carrying capacity. See *Vehicle Load Limits* ⇨ 162.

How the vehicle is loaded affects vehicle handling and ride comfort. Never load the vehicle with more weight than it was designed to carry.

When to Check

Check the tyres once a month or more.

How to Check

Use a good quality pocket-type gauge to check the tyre pressure. Proper tyre inflation cannot be determined by looking at the tyre. Check the tyre inflation pressure when the tyres are cold, meaning the vehicle has not been driven for at least three hours or no more than 1.6 km (1 mi).

Remove the valve cap from the tyre valve stem. Press the tyre gauge firmly onto the valve to

get the pressure measurement. If the cold tyre inflation pressure matches the recommended pressure on the Tyre and Loading Information label, no further adjustment is necessary.

If the inflation pressure is low, add air until the recommended pressure is reached. If the inflation pressure is high, press on the metal stem in the centre of the tyre valve to release air. Re-check the tyre pressure with the tyre gauge.

Put the valve caps back on the valve stems to keep out dirt and moisture and prevent leaks. Use only valve caps designed for the vehicle by GM. TPMS sensors could be damaged and would not be covered by the vehicle warranty.

Tyre Pressure for High-Speed Operation



Driving at high speeds, 160 km/h (100 mph) or higher, puts additional strain on tyres. Sustained high-speed driving causes excessive heat build-up and can cause sudden tyre failure. This could cause a crash, and you or others could be killed. Some high-speed rated tyres require inflation pressure adjustment for high-speed operation. When speed limits and road conditions allow the vehicle to be driven at high speeds, make sure the tyres are rated for high-speed operation, are in excellent condition, and are set to the correct cold tyre inflation pressure for the vehicle load.

The tyres require inflation pressure adjustment when driving the vehicle at speeds of 160 km/h (100 mph) or

higher, where it is legal. Set the cold inflation pressure to the maximum inflation pressure shown on the tyre sidewall, or 265 kPa (38 psi), whichever is lower. See the example following. Return the tyres to the recommended cold tyre inflation pressure when high-speed driving has ended. See *Vehicle Load Limits* ⇨ 162.

Example:

The maximum load and inflation pressure moulded on the tyre sidewall, in small letters, near the rim flange. It will read something like this: Maximum load 690 kg (1521 lbs) 300 kPa (44 psi) Max. Press.

For this example, set the inflation pressure for high-speed driving to 265 kPa (38 psi).

Racing or other competitive driving may affect the warranty coverage of the vehicle. See the warranty booklet for more information.

Tyre Pressure Monitor System

Caution

Modifications made to the Tyre Pressure Monitor System (TPMS) by anyone other than an authorised service facility may void authorisation to use the system.

The Tyre Pressure Monitor System (TPMS) uses radio and sensor technology to check tyre pressure levels. The TPMS sensors monitor the air pressure in your vehicle's tyres and transmit tyre pressure readings to a receiver located in the vehicle.

Each tyre, including the spare (if provided), should be checked monthly when cold and inflated to the inflation pressure recommended by the vehicle manufacturer on the vehicle placard or tyre inflation pressure label. (If your vehicle has tyres of a different size than the size indicated on the vehicle placard or

tyre inflation pressure label, you should determine the proper tyre inflation pressure for those tyres.)

As an added safety feature, your vehicle has been equipped with a tyre pressure monitoring system (TPMS) that illuminates a low tyre pressure telltale when one or more of your tyres is significantly under-inflated.

Accordingly, when the low tyre pressure telltale illuminates, you should stop and check your tyres as soon as possible, and inflate them to the proper pressure. Driving on a significantly under-inflated tyre causes the tyre to overheat and can lead to tyre failure. Under-inflation also reduces fuel efficiency and tyre tread life, and may affect the vehicle's handling and stopping ability.

Please note that the TPMS is not a substitute for proper tyre maintenance, and it is the driver's responsibility to maintain correct tyre pressure, even if under-inflation

has not reached the level to trigger illumination of the TPMS low tyre pressure telltale.

Your vehicle has also been equipped with a TPMS malfunction indicator to indicate when the system is not operating properly. The TPMS malfunction indicator is combined with the low tyre pressure telltale. When the system detects a malfunction, the telltale will flash for approximately one minute and then remain continuously illuminated. This sequence will continue upon subsequent vehicle start-ups as long as the malfunction exists.

When the malfunction indicator is illuminated, the system may not be able to detect or signal low tyre pressure as intended. TPMS malfunctions may occur for a variety of reasons, including the installation of replacement or alternate tyres or wheels on the vehicle that prevent the TPMS from functioning properly. Always check the TPMS malfunction telltale after replacing one or more tyres or wheels on your vehicle to ensure that the replacement or

alternate tyres and wheels allow the TPMS to continue to function properly.

See *Tyre Pressure Monitor Operation* ⇨ 252 for additional information.

See *Declaration of Conformity* ⇨ 295.

Tyre Pressure Monitor Operation

This vehicle may have a Tyre Pressure Monitor System (TPMS). The TPMS is designed to warn the driver when a low tyre pressure condition exists. TPMS sensors are mounted onto each tyre and wheel assembly on your vehicle. The TPMS sensors monitor the air pressure in the tyres and transmits the tyre pressure readings to a receiver located in the vehicle.



When a low tyre pressure condition is detected, the TPMS illuminates the low tyre pressure warning light, located in the instrument cluster. If the warning light comes on, stop as soon as possible and inflate the tyres to the recommended pressure shown on the tyre loading information label. See *Vehicle Load Limits* ⇨ 162.

A message to check the pressure in a specific tyre displays in the Driver Information Centre (DIC). The low tyre pressure warning light and the DIC warning message appear at each ignition cycle until the tyres are inflated to the correct inflation pressure. Using the DIC, tyre pressure levels can be viewed. For additional information and details about the DIC operation and displays see *Driver Information Centre (DIC)* ⇨ 111 and *Tyre Messages* ⇨ 125.

The low tyre pressure warning light may come on in cool weather when the vehicle is first started, and then turn off as the vehicle is driven. This could be an early indicator that the air pressure is getting low and needs to be inflated to the proper pressure.

A Tyre and Loading Information label shows the size of the original equipment tyres and the correct inflation pressure for the tyres when they are cold. See *Vehicle Load Limits* ⇨ 162, for an example of the Tyre and Loading Information label and its location. Also see *Tyre Pressure* ⇨ 249 for additional information.

The TPMS can warn about a low tyre pressure condition but it does not replace normal tyre maintenance. See *Tyre Inspection* ⇨ 254, *Tyre Rotation* ⇨ 254, *When It Is Time for New Tyres* ⇨ 256 and *Tyres* ⇨ 245.

Caution

Tyre sealant materials are not all the same. A non-approved tyre sealant could damage the TPMS sensors. TPMS sensor damage caused by using an incorrect tyre sealant is not covered by the vehicle warranty. Always use only the GM approved tyre sealant available through your dealer or included in the vehicle.

Factory-installed Tyre Inflator Kits use a GM approved liquid tyre sealant. Using non-approved tyre sealants could damage the TPMS sensors. See *Tyre Sealant and Compressor Kit* ⇨ 262 for information regarding the inflator kit materials and instructions.

TPMS Malfunction Light and Message

The TPMS will not function properly if one or more of the TPMS sensors are missing or inoperable. When the system detects a malfunction, the low tyre warning light flashes for about one minute and then stays on for the remainder of the ignition cycle. A DIC warning message also displays. The malfunction light and DIC warning message come on at each ignition cycle until the problem is corrected. Some of the conditions that can cause these to come on are:

- The TPMS sensor matching process was not done or not completed successfully. The malfunction light and the DIC message should go off after successfully completing the sensor matching process.

- One or more TPMS sensors are missing or damaged. The malfunction light and the DIC message should go off when the TPMS sensors are installed and the sensor matching process is performed successfully.
- Replacement tyres or wheels do not match the original equipment tyres or wheels. Tyres and wheels other than those recommended could prevent the TPMS from functioning properly. See *Buying New Tyres* ⇨ 256.
- Operating electronic devices or being near facilities using radio wave frequencies similar to the TPMS could cause the TPMS sensors to malfunction.

If the TPMS is not functioning properly, it cannot detect or signal a low tyre condition. See your dealer for service if the TPMS malfunction light and DIC message come on and stays on.

TPMS Sensor Matching Process — Auto Learn Function

Each TPMS sensor has a unique identification code. The identification code needs to be matched to a new tyre/wheel position after rotating the tyres or replacing one or more of the TPMS sensors. When a tyre is installed, the vehicle must be stationary for about 20 minutes before the system recalculates. The following relearn process takes up to 10 minutes, driving at a minimum speed of 19 km/h (12 mph). A dash (-) or pressure value will display in the DIC. See *Driver Information Centre (DIC)* ⇨ 111 and *Tyre Messages* ⇨ 125. A warning message displays in the DIC if a problem occurs during the relearn process.

Tyre Inspection

We recommend that the tyres, including the spare tyre, if the vehicle has one, be inspected for signs of wear or damage at least once a month.

Replace the tyre if:

- The indicators at three or more places around the tyre can be seen.
- There is cord or fabric showing through the tyre's rubber.
- The tread or sidewall is cracked, cut, or snagged deep enough to show cord or fabric.
- The tyre has a bump, bulge, or split.
- The tyre has a puncture, cut, or other damage that cannot be repaired well because of the size or location of the damage.

Tyre Rotation

The tyres should be rotated at the intervals specified in the Maintenance Schedule. See *Scheduled Maintenance* ⇨ 283.

Tyres are rotated to achieve uniform wear for all tyres. The first rotation is the most important.

Anytime unusual wear is noticed, rotate the tyres as soon as possible, check for proper tyre inflation pressure, and check for damaged tyres or wheels. If the unusual wear continues after the rotation, check the wheel alignment. See *When It Is Time for New Tyres* ⇨ 256 and *Wheel Replacement* ⇨ 259.

Different tyre sizes should not be rotated front to rear.

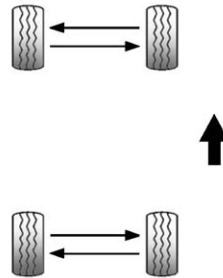

Use this rotation pattern if the vehicle has different size tyres on the front and rear.

Adjust the front and rear tyres to the recommended inflation pressure on the Tyre and Loading Information label after the tyres have been rotated. See *Tyre Pressure* ⇨ 249 and *Vehicle Load Limits* ⇨ 162.

Reset the Tyre Pressure Monitor System. See *Tyre Pressure Monitor Operation* ⇨ 252.

Check that all wheel nuts are properly tightened. See “Wheel Nut Torque” under *Capacities and Specifications* ⇨ 291.

Warning

Rust or dirt on a wheel, or on the parts to which it is fastened, can make wheel nuts become loose after time. The wheel could come off and cause an accident. When changing a wheel, remove any rust or dirt from places where the wheel attaches to the vehicle. In an emergency, a cloth or a paper towel can be used; however, use a scraper or wire brush later to remove all rust or dirt.

Lightly coat the centre of the wheel hub with wheel bearing grease after a wheel change or tyre rotation to prevent corrosion or rust build-up. Do not get grease on the flat wheel mounting surface or on the wheel nuts or bolts.

When It Is Time for New Tyres

Factors such as maintenance, temperatures, driving speeds, vehicle loading, and road conditions affect the wear rate of the tyres.

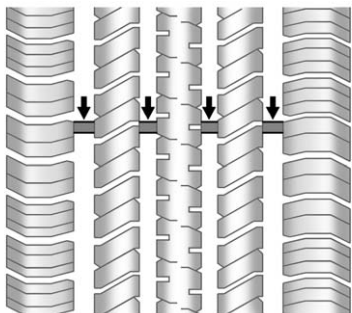

Tread wear indicators are one way to tell when it is time for new tyres. Tread wear indicators appear when the tyres have only 1.6 mm (1/16 in) or less of tread remaining. See *Tyre Inspection* ⇨ 254 and *Tyre Rotation* ⇨ 254.

The rubber in tyres ages over time. This also applies to the spare tyre, if the vehicle has one, even if it is never used. Multiple factors including temperatures, loading conditions, and inflation pressure maintenance affect how fast ageing takes place. GM recommends that tyres, including the spare if equipped, be replaced after six years, regardless of tread wear. The tyre manufacture date is the last four digits of the DOT Tyre Identification Number (TIN) which is moulded into one side of the tyre sidewall. The first two digits represent the week (01–52) and the last two digits, the year. For example, the third week of the year 2010 would have a four-digit DOT date of 0310.

Vehicle Storage

Tyres age when stored normally mounted on a parked vehicle. Park a vehicle that will be stored for at least a month in a cool, dry, clean area away from direct sunlight to slow ageing. This area should be

free of grease, petrol, or other substances that can deteriorate rubber.

Parking for an extended period can cause flat spots on the tyres that may result in vibrations while driving. When storing a vehicle for at least a month, remove the tyres or raise the vehicle to reduce the weight from the tyres.

Buying New Tyres

GM has developed and matched specific tyres for the vehicle. The original equipment tyres installed were designed to meet General Motors Tyre Performance Criteria Specification (TPC Spec) system rating. When replacement tyres are needed, GM strongly recommends buying tyres with the same TPC Spec rating.

GM's exclusive TPC Spec system considers over a dozen critical specifications that impact

the overall performance of the vehicle, including brake system performance, ride and handling, traction control, and tyre pressure monitoring performance. GM's TPC Spec number is moulded onto the tyre's sidewall near the tyre size. If the tyres have an all-season tread design, the TPC Spec number will be followed by MS for mud and snow.

GM recommends replacing worn tyres in complete sets of four. Uniform tread depth on all tyres will help to maintain the performance of the vehicle. Braking and handling performance may be adversely affected if all the tyres are not replaced at the same time. If proper rotation and maintenance have been done, all four tyres should wear out at about the same time. See *Tyre Rotation* ⇨ 254 for information on proper tyre rotation.

However, if it is necessary to replace only one axle set of worn tyres, place the new tyres on the rear axle.

 **Warning**

Tyres could explode during improper service. Attempting to mount or dismount a tyre could cause injury or death. Only your dealer or authorised tyre service centre should mount or dismount the tyres.

Winter tyres with the same speed rating as the original equipment tyres may not be available for H, V, W, Y and ZR speed rated tyres. Never exceed the winter tyres maximum speed capability when using winter tyres with a lower speed rating.

 **Warning**

Never drive faster than the speed the tyres are rated, regardless of the legal speed limit. When frequently driving the vehicle at high speeds and/or for prolonged periods of time, check with your vehicle/tyre dealer for the proper type of tyres to use for the specific driving and weather conditions.

 **Warning**

Mixing tyres of different sizes (other than those originally installed on the vehicle), brands, or types may cause loss of control of the vehicle, resulting in a crash or other vehicle damage. Use the correct size, brand, and type of tyre on all four wheels.

 **Warning**

Using bias-ply tyres on the vehicle may cause the wheel rim flanges to develop cracks after many miles of driving. A tyre and/or wheel could fail suddenly and cause a crash. Use only radial-ply tyres with the wheels on the vehicle.

If the vehicle tyres must be replaced with a tyre that does not have a TPC Spec number, make sure they are the same size, load range, speed rating, and construction type (radial) as the original tyres.

Vehicles that have a tyre pressure monitoring system could give an inaccurate low-pressure warning if non-TPC Spec rated tyres are installed. See *Tyre Pressure Monitor Operation* ⇨ 252.

The Tyre and Loading Information label indicates the original equipment tyres on the vehicle. See *Vehicle Load Limits* ⇨ 162, for the label location and more information about the Tyre and Loading Information label.

Different Size Tyres and Wheels

If wheels or tyres are installed that are a different size than the original equipment wheels and tyres, vehicle performance, including its braking, ride and handling characteristics, stability, and resistance to rollover may be affected. If the vehicle has electronic systems such as antilock brakes, rollover airbags, traction control, electronic stability control, or All-Wheel Drive, the performance of these systems can also be affected.

 **Warning**

If different sized wheels are used, there may not be an acceptable level of performance and safety if tyres not recommended for those wheels are selected. This increases the chance of a crash and serious injury. Only use GM specific wheel and tyre systems developed for the vehicle, and have them properly installed by a GM certified technician.

See *Buying New Tyres* ⇨ 256 and *Accessories and Modifications* ⇨ 203.

Wheel Alignment and Tyre Balance

The tyres and wheels were aligned and balanced at the factory to provide the longest tyre life and best overall performance. Adjustments to wheel alignment and tyre balancing are not necessary on a regular basis. Consider an alignment check if there is unusual tyre wear. If the

vehicle is vibrating when driving on a smooth road, the tyres and wheels may need to be rebalanced. See your dealer for proper diagnosis.

Road Imperfections/Crown Effects

The vehicle's precise steering and handling make it very responsive to road surface feedback. A slight pull may be felt in the steering depending on the crown of the road and/or other road surface variations such as troughs or ruts. This is normal and the vehicle does not require service.

Tyre Chatter/Hop

When driving at slow speeds and in very tight turns, the vehicle may have tyre chatter/hop. This is normal and the vehicle does not require service.

Wheel Replacement

Replace any wheel that is bent, cracked, or badly rusted or corroded. If wheel nuts keep coming loose, the wheel, wheel bolts, and wheel nuts should be replaced. If the wheel leaks air, replace it.

Some aluminium wheels can be repaired. See your dealer if any of these conditions exist.

Your dealer will know the kind of wheel that is needed.

Each new wheel should have the same load-carrying capacity, diameter, width, offset, and be mounted the same way as the one it replaces.

Replace wheels, wheel bolts, or wheel nuts with new GM original equipment parts.

Warning

Using the wrong replacement wheels, wheel bolts, or wheel nuts can be dangerous. It could affect the braking and handling of the vehicle. Tyres can lose air, and cause loss of control, causing a crash. Always use the correct wheel, wheel bolts, and wheel nuts for replacement.

Warning

Replacing a wheel with a used one is dangerous. How it has been used or how far it has been driven may be unknown. It could fail suddenly and cause a crash. When replacing wheels, use a new GM original equipment wheel.

Caution

The wrong wheel can also cause problems with bearing life, brake cooling, speedometer or odometer calibration, headlight aim, bumper height, vehicle ground clearance and tyre clearance to the body and chassis.

Tightening Wheel Lug Nuts

Warning

Never use oil or grease on studs or the threads of the wheel nuts. The wheel nuts might come loose and the wheel could fall off, causing a crash.

Warning

Incorrect wheel nuts or improperly tightened wheel nuts can cause the wheel to become loose and even come off. This could lead to a crash. Be sure to use the correct wheel nuts. If you have to replace them, be sure to get new GM original equipment wheel nuts.

Caution

Improperly tightened wheel nuts can lead to brake pulsation and disc damage. To avoid expensive brake repairs, evenly tighten the wheel nuts in the proper sequence and to the proper torque specification.

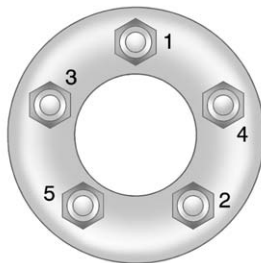

Tighten the wheel lug nuts firmly in a crisscross sequence. See *Capacities and Specifications* ⇨ 291.

Tyre Chains

Use tyre chains only where legal and only when necessary.

Only use low profile chains that are the correct size for P285/30ZR20 or P335/25ZR20 tires.

Install them on the tires of the rear axle only.

Caution

Do not install traction devices on the front tyres.

Tighten the chains as tightly as possible with the ends securely fastened.

Drive slowly and follow the chain manufacturer's instructions. If the chains contact the vehicle, stop and retighten them. If the contact continues, slow down until it stops.

Caution

To help avoid damage to the vehicle, drive slowly, do not spin the wheels, and readjust or remove the device if it contacts the vehicle.

If a Tyre Goes Flat

It is unusual for a tyre to blow out while driving, especially if the tyres are maintained properly. If air goes out of a tyre, it is much more likely to leak out slowly. See *Tyres* ⇨ 245 for additional information. But if there ever is a blowout, here are a few tips about what to expect and what to do:

If a front tyre fails, the flat tyre creates a drag that pulls the vehicle toward that side. Take your foot off the accelerator pedal and grip the steering wheel firmly. Steer to maintain lane position, and then gently brake to a stop, well off the road, if possible.

A rear blowout, particularly on a curve, acts much like a skid and may require the same correction as used in a skid. Stop pressing the accelerator pedal and steer to straighten the vehicle. It may be very bumpy and noisy. Gently brake to a stop, well off the road, if possible.

The vehicle has no spare tyre, no tyre changing equipment and no place to store a tyre.

If the vehicle has run-flat tyres, there is no need to stop on the side of the road to change a flat tyre. See *Run-Flat Tyres* ⇨ 246.

⚠ Warning

Special tools and procedures are required to service a run-flat tyre. If these special tools and procedures are not used, injury or vehicle damage may occur. Always be sure the proper tools and procedures, as described in the service manual, are used.

If this vehicle does not have run-flat tyres and a tyre goes flat, avoid further tyre and wheel damage by driving slowly to a level place, well off the road, if possible. Turn on the hazard warning flashers. See *Hazard Warning Flashers* ⇨ 136.

1. Turn on the hazard warning flashers.
2. Apply the parking brake firmly.
3. Put an automatic transmission in P (Park) or a manual gearbox in 1 (First) or R (Reverse).
4. Turn off the ignition.
5. Inspect the flat tyre.

⚠ Warning

Driving on a flat tyre will cause permanent damage to the tyre. Re-inflating a tyre after it has been driven on while severely underinflated or flat may cause a blowout and a serious crash. Never attempt to re-inflate a tyre

(Continued)

Warning (Continued)

that has been driven on while severely underinflated or flat. Have your dealer or an authorised tyre service centre repair or replace the flat tyre as soon as possible.

If this vehicle has a tyre sealant kit and the tyre has been separated from the wheel, has damaged sidewalls, or has a puncture larger than 6 mm (0.25 in), the tyre is too severely damaged for the tyre sealant and compressor kit to be effective. If the tyre has a puncture less than 6 mm (0.25 in) in the tread area of the tyre, see *Tyre Sealant and Compressor Kit* ⇨ 262.

Tyre Sealant and Compressor Kit **Warning**

Idling a vehicle in an enclosed area with poor ventilation is dangerous. Engine exhaust may enter the vehicle. Engine exhaust contains carbon monoxide (CO) which cannot be seen or smelled. It can cause unconsciousness and even death. Never run the engine in an enclosed area that has no fresh air ventilation. For more information, see *Engine Exhaust* ⇨ 174.

 **Warning**

Overinflating a tyre could cause the tyre to rupture and you or others could be injured. Be sure to read and follow the tyre sealant and compressor kit instructions and inflate the tyre to its

(Continued)

Warning (Continued)

recommended pressure. Do not exceed the recommended pressure.

 **Warning**

Storing the tyre sealant and compressor kit or other equipment in the passenger compartment of the vehicle could cause injury. In a sudden stop or collision, loose equipment could strike someone. Store the tyre sealant and compressor kit in its original location.

If this vehicle has a tyre sealant and compressor kit, there may not be a spare tyre or tyre changing equipment, and on some vehicles there may not be a place to store a tyre.

To obtain a tyre sealant and compressor kit, see your dealer.

The tyre sealant and compressor can be used to temporarily seal punctures up to 6 mm (0.25 in) in the tread area of the tyre. It can also be used to inflate an under inflated tyre.

If the tyre has been separated from the wheel, has damaged sidewalls, or has a large puncture, the tyre is too severely damaged for the tyre sealant and compressor kit to be effective.

Read and follow all of the tyre sealant and compressor kit instructions.

The kit includes:

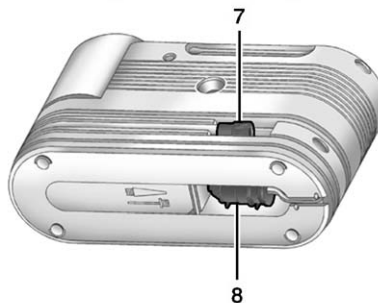
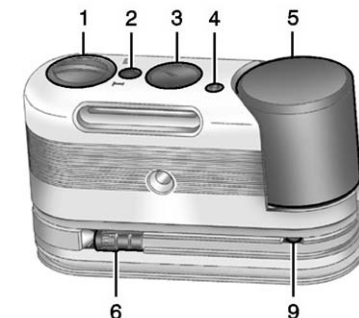

1. Selector Switch (Sealant/Air or Air Only)
2. On/Off Button
3. Pressure Gauge
4. Pressure Deflation Button

5. Tyre Sealant Canister
6. Sealant/Air Hose (Clear)
7. Air Only Hose (Black)
8. Power Plug
9. Canister Release Button (Under Sealant/Air Hose)

Tyre Sealant

Read and follow the safe handling instructions on the label adhered to the sealant canister.

Check the tyre sealant expiration date on the sealant canister. The sealant canister should be replaced before its expiration date. Replacement sealant canisters are available at your local dealer. See "Removal and Installation of the Sealant Canister" following.

There is only enough sealant to seal one tyre. After usage, the sealant canister and sealant/air hose assembly must be replaced. See "Removal and Installation of the Sealant Canister" following.

Using the Tyre Sealant and Compressor Kit to Temporarily Seal and Inflate a Punctured Tyre

Follow the directions closely for correct sealant usage.

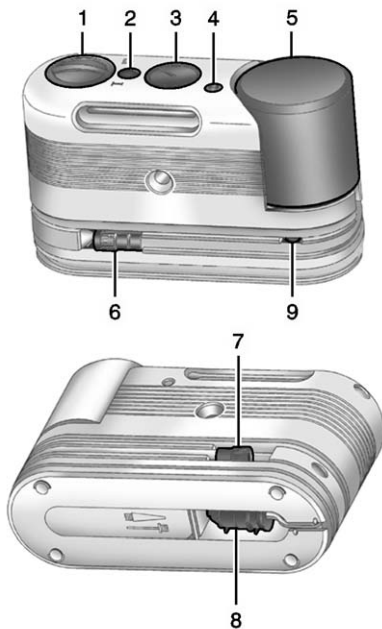

1. Selector Switch (Sealant/Air or Air Only)
2. On/Off Button
3. Pressure Gauge
4. Pressure Deflation Button

5. Tyre Sealant Canister
6. Sealant/Air Hose (Clear)
7. Air Only Hose (Black)
8. Power Plug
9. Canister Release Button (Under Sealant/Air Hose)

When using the tyre sealant and compressor kit during cold temperatures, warm the kit in a heated environment for five minutes. This will help to inflate the tyre faster.

If a tyre goes flat, avoid further tyre and wheel damage by driving slowly to a level place. Turn on the hazard warning flashers. See *Hazard Warning Flashers* ⇨ 136.

See *If a Tyre Goes Flat* ⇨ 261 for other important safety warnings.

Do not remove any objects that have penetrated the tyre.

1. Remove the tyre sealant and compressor kit from its storage location. See *Storing the Tyre Sealant and Compressor Kit* ⇨ 269.
2. Unwrap the sealant/air hose (6) and the power plug (8).

3. Place the kit on the ground.
Make sure the tyre valve stem is positioned close to the ground so the hose will reach it.

4. Remove the valve stem cap from the flat tyre by turning it anticlockwise.

5. Attach the sealant/air hose (6) onto the tyre valve stem. Turn it clockwise until it is tight.

6. Plug the power plug (8) into the accessory power outlet in the vehicle. Unplug all items from other accessory power outlets. See *Power Outlets* ⇨ 93.

If the vehicle has an accessory power outlet, do not use the cigarette lighter.

If the vehicle only has a cigarette lighter, use the cigarette lighter.

Do not pinch the power plug cord in the door or window.

7. Start the vehicle. The vehicle must be running while using the air compressor.

8. Press and turn the selector switch (1) anticlockwise to the Sealant + Air position.

9. Press the on/off button (2) to turn the tyre sealant and compressor kit on.

The compressor will inject sealant and air into the tyre.

The pressure gauge (3) will initially show a high pressure while the compressor pushes the sealant into the tyre. Once the sealant is completely dispersed into the tyre, the pressure will quickly drop and start to rise again as the tyre inflates with air only.

10. Inflate the tyre to the recommended inflation pressure using the pressure gauge (3). The recommended inflation pressure can be found on the Tyre and Loading Information label. See *Tyre Pressure* ⇨ 249.

The pressure gauge (3) may read higher than the actual tyre pressure while the compressor

is on. Turn the compressor off to get an accurate reading. The compressor may be turned on/off until the correct pressure is reached.

Caution

If the recommended pressure cannot be reached after approximately 25 minutes, the vehicle should not be driven farther. The tyre is too severely damaged and the tyre sealant and compressor kit cannot inflate the tyre. Remove the power plug from the accessory power outlet and unscrew the inflating hose from the tyre valve.

11. Press the on/off button (2) to turn the tyre sealant and compressor kit off.

The tyre is not sealed and will continue to leak air until the vehicle is driven and the sealant is distributed in the

tyre, therefore, Steps 12–18 must be done immediately after Step 11.

Be careful while handling the tyre sealant and compressor kit as it could be warm after usage.

12. Unplug the power plug (8) from the accessory power outlet in the vehicle.
13. Turn the sealant/air hose (6) anticlockwise to remove it from the tyre valve stem.
14. Replace the tyre valve stem cap.
15. Replace the sealant/air hose (6), and the power plug (8) back in their original location.



16. If the flat tyre was able to inflate to the recommended inflation pressure, remove the

maximum speed label from the sealant canister (5) and place it in a highly visible location. Do not exceed the speed on this label until the damaged tyre is repaired or replaced.

17. Return the equipment to its original storage location in the vehicle.
18. Immediately drive the vehicle 8 km (5 mi) to distribute the sealant in the tyre.
19. Stop at a safe location and check the tyre pressure. Refer to Steps 1–11 under “Using the Tyre Sealant and Compressor Kit without Sealant to Inflate a Tyre (Not Punctured).”

If the tyre pressure has fallen more than 68 kPa (10 psi) below the recommended inflation pressure, stop driving the vehicle. The tyre is too severely damaged and the tyre sealant cannot seal the tyre.

If the tyre pressure has not dropped more than 68 kPa (10 psi) from the recommended

inflation pressure, inflate the tyre to the recommended inflation pressure.

20. Wipe off any sealant from the wheel, tyre and vehicle.
21. Dispose of the used sealant canister (5) and sealant/air hose (6) assembly at a local dealer or in accordance with local state codes and practices.
22. Replace with a new canister assembly available from your dealer.
23. After temporarily sealing the tyre using the tyre sealant and compressor kit, take the vehicle to an authorised dealer within 161 km (100 mi) of driving to have the tyre repaired or replaced.

Using the Tyre Sealant and Compressor Kit without Sealant to Inflate a Tyre (Not Punctured)

To use the air compressor to inflate a tyre with air only and not sealant:

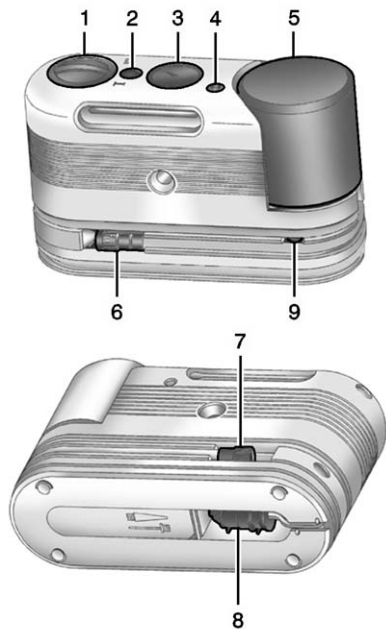

1. Selector Switch (Sealant/Air or Air Only)
2. On/Off Button
3. Pressure Gauge
4. Pressure Deflation Button

5. Tyre Sealant Canister
6. Sealant/Air Hose (Clear)
7. Air Only Hose (Black)
8. Power Plug
9. Canister Release Button (Under Sealant/Air Hose)

If a tyre goes flat, avoid further tyre and wheel damage by driving slowly to a level place. Turn on the hazard warning flashers. See *Hazard Warning Flashers* ⇨ 136.

See *If a Tyre Goes Flat* ⇨ 261 for other important safety warnings.

1. Remove the tyre sealant and compressor kit from its storage location. See *Storing the Tyre Sealant and Compressor Kit* ⇨ 269.
2. Unwrap the air only hose (7) and the power plug (8).
3. Place the kit on the ground.

Make sure the tyre valve stem is positioned close to the ground so the hose will reach it.

4. Remove the tyre valve stem cap from the flat tyre by turning it anticlockwise.
5. Attach the air only hose (7) onto the tyre valve stem by turning it clockwise until it is tight.
6. Plug the power plug (8) into the accessory power outlet in the vehicle. Unplug all items from other accessory power outlets. See *Power Outlets* ⇨ 93.

If the vehicle has an accessory power outlet, do not use the cigarette lighter.

If the vehicle only has a cigarette lighter, use the cigarette lighter.

Do not pinch the power plug cord in the door or window.

7. Start the vehicle. The vehicle must be running while using the air compressor.
8. Press and turn the selector switch (1) clockwise to the Air Only position.

9. Press the on/off button (2) to turn the compressor on.
The compressor will inflate the tyre with air only.

10. Inflate the tyre to the recommended inflation pressure using the pressure gauge (3). The recommended inflation pressure can be found on the Tyre and Loading Information label. See *Tyre Pressure* ⇨ 249.

The pressure gauge (3) may read higher than the actual tyre pressure while the compressor is on. Turn the compressor off to get an accurate reading. The compressor may be turned on/off until the correct pressure is reached.

If you inflate the tyre higher than the recommended pressure you can adjust the excess pressure by pressing the pressure deflation button (4) until the proper pressure reading is reached.

This option is only functional when using the air only hose (7).

11. Press the on/off button (2) to turn the tyre sealant and compressor kit off.
Be careful while handling the tyre sealant and compressor kit as it could be warm after usage.
12. Unplug the power plug (8) from the accessory power outlet in the vehicle.
13. Disconnect the air only hose (7) from the tyre valve stem, by turning it anticlockwise, and replace the tyre valve stem cap.
14. Replace the air only hose (7) and the power plug (8) and cord back in its original location.
15. Place the equipment in the original storage location in the vehicle.

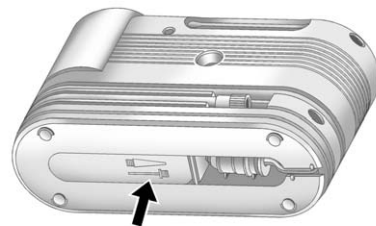

The tyre sealant and compressor kit has an accessory adapter located in a compartment on the bottom of its housing that may be used to inflate air mattresses, balls, etc.

Removal and Installation of the Sealant Canister

To remove the sealant canister:

1. Unwrap the sealant hose.
2. Press the canister release button (9).
3. Pull up and remove the canister.

4. Replace with a new canister which is available from your dealer.
5. Push the new canister into place.

Storing the Tyre Sealant and Compressor Kit

The tyre sealant and compressor kit, if equipped, should be stored in the storage area behind the left rear wheel opening in the rear compartment when it is not being used.

To access the storage area:

1. Open the hatch/boot. See *Hatch (Boot)* ⇨ 34.

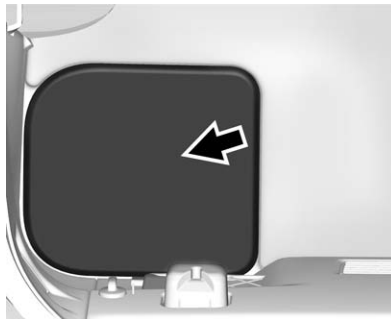

2. Lift the storage cover.

Jump Starting

For more information about the vehicle battery, see *Battery* ⇨ 228.

If the battery has run down, use another vehicle and some jumper cables to start the vehicle. Be sure to use the following steps to do it safely.

Warning

Batteries can hurt you. They can be dangerous because:

- They contain acid that can burn you.
- They contain gas that can explode or ignite.
- They contain enough electricity to burn you.

If you do not follow these steps exactly, some or all of these things can hurt you.

Caution

Ignoring these steps could result in costly damage to the vehicle that would not be covered by the vehicle warranty. Trying to start the vehicle by pushing or pulling it will not work, and it could damage the vehicle.

The battery is under a battery cover in the hatch/boot area on the passenger side under the carpet.

Before you connect the cables, here are some basic things you should know. Positive (+) will go to the positive (+) terminal. Negative (-) will go to the negative (-) terminal.

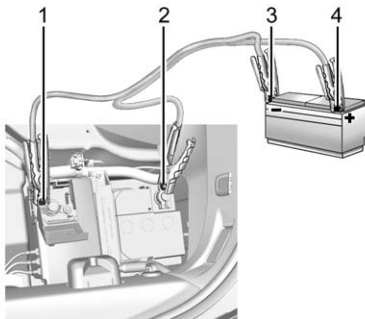

1. Discharged Battery Positive (+) Terminal
 2. Discharged Battery Negative (-) Terminal
 3. Good Battery Negative (-) Terminal
 4. Good Battery Positive (+) Terminal
1. Check the other vehicle. It must have a 12-volt battery with a negative ground system.

Caution

If the other vehicle does not have a 12-volt system with a negative ground, both vehicles can be damaged. Only use a vehicle that has a 12-volt system with a negative ground for jump starting.

2. Get the vehicles close enough so the jump leads can reach, but be sure the vehicles are not touching each other. If they are, it could cause a ground connection you do not want. You would not be able to start the vehicle, and the bad grounding could damage the electrical systems.

To avoid the possibility of the vehicles rolling, apply the parking brake firmly on both vehicles involved in the jump start procedure. Put an automatic transmission in P (Park) or a manual gearbox in Neutral before setting the parking brakes.

Caution

If any accessories are left on or plugged in during the jump starting procedure, they could be damaged. The repairs would not be covered by the vehicle warranty. Whenever possible, turn off or unplug all accessories on either vehicle when jump starting.

3. Turn off the ignition on both vehicles. Unplug unnecessary accessories plugged into the cigarette lighter or the accessory power outlet. Turn off the radio and all lamps that are not needed. This will avoid sparks and help save both batteries. And it could save the radio!

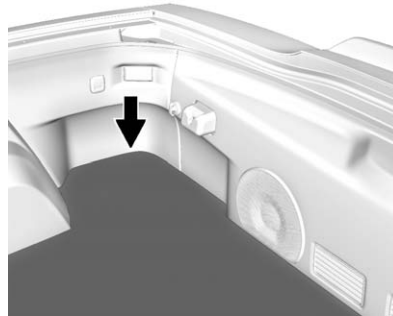

4. Open the rear tailgate/boot and lift the carpet on the passenger side of the vehicle to gain access to the battery cover.

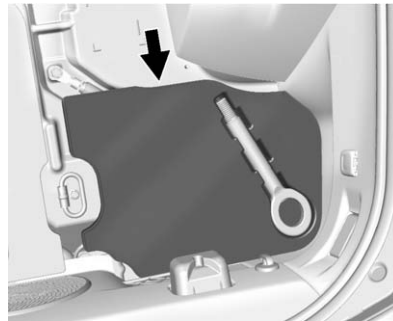

5. Remove the battery cover and locate the positive (+) and negative (-) terminals.
6. Check that the jump leads do not have loose or missing insulation. If they do, you could get a shock. The vehicles could be damaged too.
7. Open the positive terminal trim cover and connect the red positive (+) cable to the positive (+) terminal (1) of the dead battery.
8. Do not let the other end touch metal. Connect it to the positive (+) terminal (4) of the good battery.
9. Now connect the black negative (-) cable to the negative (-) terminal (3) of the good battery.
Do not let the other end touch anything until the next step.
10. Connect the other end of the negative (-) cable to the negative (-) terminal (2) on the dead battery.

11. Now start the vehicle with the good battery and run the engine for a while.
12. Try to start the vehicle that had the dead battery. If it will not start after a few tries, it probably needs service.

Caution

If the jump leads are connected or removed in the wrong order, electrical shorting may occur and damage the vehicle. The repairs would not be covered by the vehicle warranty. Always connect and remove the jump leads in the correct order, making sure that the cables do not touch each other or other metal.

Jump Lead Removal

Reverse the sequence exactly when removing the jump leads.

After starting the disabled vehicle and removing the jump leads, allow it to idle for several minutes.

The power windows may need to be initialised. See “Window Indexing” under *Power Windows* ⇨ 41.

Towing the Vehicle**Caution**

Incorrectly towing a disabled vehicle may cause damage. The damage would not be covered by the vehicle warranty. Do not lash or hook to any suspension components — including the control arms, stabiliser bars, and links — during towing and recovery of a disabled vehicle, or when securing the vehicle to a flatbed car carrier. For towing and recovery of a disabled vehicle, use the proper hooks in the correct locations on the front and rear sub-frames. Use the proper nylon strap harnesses around the tyres to secure them to the flatbed car carrier.

Have the vehicle towed on a flatbed car carrier. A wheel lift tow truck could damage the vehicle.

Consult your dealer or a professional towing service if the disabled vehicle must be towed.

Use the tow eye for towing a disabled vehicle or loading it onto a flatbed car carrier. The tow eye should not be used to recover a vehicle from an off road situation.

Caution

Improper use of the tow eye can cause vehicle damage. Use caution and low speeds to prevent damage to the vehicle.

The front tow eye socket is accessible through the grille opening.

The rear tow eye socket is behind a cover in the rear fascia. Carefully open the cover by using the small notch.

Install the tow eye into the socket by turning it clockwise until it stops. When the tow eye is removed, reinstall the cover with the notch in the original position.

To tow the vehicle behind another vehicle for recreational purposes, such as behind a motor home, see "Recreational Vehicle Towing" in this section.

Recreational Vehicle Towing

Caution

Dolly towing or dinghy towing the vehicle may cause damage because of reduced ground clearance. Always put the vehicle on a flatbed truck or trailer.

The vehicle was neither designed nor intended to be towed with any of its wheels on the ground. If the vehicle must be towed, see *Towing the Vehicle* ⇨ 272.

Appearance Care

Exterior Care

Locks

Locks are lubricated at the factory. Use a de-icing agent only when absolutely necessary, and have the locks greased after using. See *Recommended Fluids and Lubricants* ⇨ 286.

Washing the Vehicle

To preserve the vehicle's finish, wash it often and out of direct sunlight.

Caution

Do not use petroleum-based, acidic, or abrasive cleaning agents as they can damage the vehicle's paint, metal, or plastic parts. If damage occurs, it would not be covered by the vehicle warranty. Approved cleaning products can be obtained from

(Continued)

Caution (Continued)

your dealer. Follow all manufacturer directions regarding correct product usage, necessary safety precautions, and appropriate disposal of any vehicle care product.

Caution

Avoid using high-pressure washers closer than 30 cm (12 in) to the surface of the vehicle. Use of power washers exceeding 8,274 kPa (1,200 psi) can result in damage or removal of paint and decals.

The  symbol is on any underbonnet compartment electrical centre that should not be power washed. This could cause damage that would not be covered by the vehicle warranty.

If using an automatic car wash, comply with the car wash instructions. The windscreen wiper must be off. Remove any accessories that may be damaged or interfere with the car wash equipment.

Rinse the vehicle well, before washing and after, to remove all cleaning agents completely. If they are allowed to dry on the surface, they could stain.

Dry the finish with a soft, clean chamois or an all-cotton towel to avoid surface scratches and water spotting.

Finish Care

Application of aftermarket clearcoat sealant/wax materials is not recommended. If painted surfaces are damaged, see your dealer to have the damage assessed and repaired. Foreign materials such as calcium chloride and other salts, ice melting agents, road oil and tar, tree sap, bird droppings, chemicals from industrial chimneys, etc., can damage the vehicle's finish if they remain on painted surfaces. Wash

the vehicle as soon as possible. If necessary, use non-abrasive cleaners that are marked safe for painted surfaces to remove foreign matter.

Occasional hand waxing or mild polishing should be done to remove residue from the paint finish. See your dealer for approved cleaning products.

Do not apply waxes or polishes to uncoated plastic, vinyl, rubber, decals, simulated wood, or flat paint as damage can occur.

Caution

Machine compounding or aggressive polishing on a base coat/clear coat paint finish may damage it. Use only non-abrasive waxes and polishes that are made for a base coat/clear coat paint finish on the vehicle.

To keep the paint finish looking new, keep the vehicle garaged or covered whenever possible.

Protecting Exterior Bright Metal Mouldings

Caution

Failure to clean and protect the bright metal mouldings can result in a hazy white finish or pitting. This damage would not be covered by the vehicle warranty.

The bright metal mouldings on the vehicle are aluminium, chrome, and stainless steel. To prevent damage always follow these cleaning instructions:

- Be sure the moulding is cool to the touch before applying any cleaning solution.
- Use only approved cleaning solutions for aluminium, chrome and stainless steel. Some cleaners are highly acidic or contain alkaline substances and can damage the mouldings.
- Always dilute a concentrated cleaner according to the manufacturer's instructions.

- Do not use cleaners that are not intended for automotive use.
- Use a nonabrasive wax on the vehicle after washing to protect and extend the moulding finish.

Convertible Top Care

Frequently hand wash convertible tops with mild car wash soap. Never use a stiff brush, steam, bleach, or aggressive cleaners.

If necessary, a soft brush can be used to remove dirt. When finished cleaning, thoroughly rinse the fabric. Avoid automatic car washes with overhead brushes or very high-pressure sprays as they can cause damage and leaking.

Only lower the top when it is completely dry and avoid leaving the top lowered for extended periods of time to prevent excessive interior weathering.

Avoid leaving large amounts of snow on the top for extended periods of time as damage may also occur.

Carbon Fiber Care

Carbon fiber parts can be washed and waxed like any other parts. Use a clear or black pigmented wax. See *Carbon Fiber* ⇨ 167.

Cleaning Exterior Lamps/ Lenses, Emblems, Decals, and Stripes

Use only lukewarm or cold water, a soft cloth, and a car washing soap to clean exterior lamps, lenses, emblems, decals, and stripes. Follow instructions under "Washing the Vehicle" previously in this section.

Lamp covers are made of plastic, and some have a UV protective coating. Do not clean or wipe them while they are dry.

Do not use any of the following on lamp covers:

- Abrasive or caustic agents.
- Washer fluids and other cleaning agents in higher concentrations than suggested by the manufacturer.

- Solvents, alcohols, fuels, or other harsh cleaners.
- Ice scrapers or other hard items.
- Aftermarket appearance caps or covers while the lamps are illuminated, due to excessive heat generated.

Caution

Failure to clean lamps properly can cause damage to the lamp cover that would not be covered by the vehicle warranty.

Caution

Using wax on low gloss black finish stripes can increase the gloss level and create a non-uniform finish. Clean low gloss stripes with soap and water only.

Air Intakes

Clear debris from the air intakes, between the bonnet and windscreen, when washing the vehicle.

Windscreen and Wiper Blades

Clean the outside of the windscreen with glass cleaner.

Clean rubber blades using lint-free cloth or paper towel soaked with windscreen washer fluid or a mild detergent. Wash the windscreen thoroughly when cleaning the blades. Insects, road grime, sap, and a build-up of vehicle wash/wax treatments may cause wiper streaking.

Replace the wiper blades if they are worn or damaged. Damage can be caused by extreme dusty conditions, sand, salt, heat, sun, snow, and ice.

Weatherstrips

Apply Dielectric silicone grease on weatherstrips to make them last longer, seal better, and not stick or squeak. Lubricate weatherstrips at

least once a year. Hot, dry climates require more frequent application. Black marks from rubber material on painted surfaces can be removed by rubbing with a clean cloth. See *Recommended Fluids and Lubricants* ⇨ 286.

Tyres

Use a stiff brush with tyre cleaner to clean the tyres.

Caution

Using petroleum-based tyre dressing products on the vehicle may damage the paint finish and/or tyres. When applying a tyre dressing, always wipe off any overspray from all painted surfaces on the vehicle.

Wheels and Trim - Aluminium or Chrome

Use a soft, clean cloth with mild soap and water to clean the wheels. After rinsing thoroughly with clean water, dry with a soft, clean towel. A wax may then be applied.

Caution

Chrome wheels and other chrome trim may be damaged if the vehicle is not washed after driving on roads that have been sprayed with magnesium, calcium, or sodium chloride. These chlorides are used on roads for conditions such as ice and dust. Always wash the chrome with soap and water after exposure.

Caution

To avoid surface damage, do not use strong soaps, chemicals, abrasive polishes, cleaners, brushes, or cleaners that contain acid on aluminium or chrome-plated wheels. Use only approved cleaners. Also, never drive a vehicle with aluminium or chrome-plated wheels through an automatic car wash that uses silicone carbide tyre cleaning

(Continued)

Caution (Continued)

brushes. Damage could occur and the repairs would not be covered by the vehicle warranty.

Brake System

Visually inspect brake lines and hoses for proper hook-up, binding, leaks, cracks, chafing, etc. Inspect disc brake pads for wear and discs for surface condition. Inspect drum brake linings/shoes for wear or cracks. Inspect other brake parts, including drums, wheel cylinders, callipers, parking brake, master cylinder, brake fluid reservoir, vacuum pipes, electric vacuum pump including bracket and vent hose, if equipped.

Steering, Suspension, and Chassis Components

Visually inspect steering, suspension, and chassis components for damaged, loose, or missing parts or signs of wear at least once a year.

Inspect power steering for proper hook-up, binding, leaks, cracks, chafing, etc.

Visually check constant velocity joint boots and axle seals for leaks.

Body Component Lubrication

Lubricate all key lock cylinders, hood hinges, and liftgate hinges, unless the components are plastic. Applying silicone grease on weatherstrips with a clean cloth will make them last longer, seal better, and not stick or squeak.

Underbody Maintenance

At least twice a year, spring and fall, use plain water to flush any corrosive materials from the underbody. Take care to thoroughly clean any areas where mud and other debris can collect.

Do not directly power wash the transfer case and/or front/rear axle output seals. High pressure water can overcome the seals and contaminate the fluid. Contaminated fluid will decrease the life of the transfer case and/or axles and should be replaced.

Composite Springs

Caution

Do not use acidic or corrosive cleaning products, engine degreasers, or aluminium cleaning agents on fibreglass springs as it may cause damage. The repairs would not be covered by the vehicle warranty. Use only approved cleaners.

Body Damage

If the vehicle is damaged and requires sheet metal repair or replacement, make sure the body repair shop applies anti-corrosion material to parts repaired or replaced to restore corrosion protection.

Original manufacturer replacement parts will provide the corrosion protection while maintaining the vehicle warranty.

Finish Damage

Quickly repair minor chips and scratches with touch-up materials available from your dealer. Larger areas of finish damage can be corrected in your dealer's body and paint shop.

Chemical Paint Spotting

Airborne pollutants can fall upon and attack painted vehicle surfaces causing blotchy, ring-shaped discolourations, and small, irregular dark spots etched into the paint surface. See "Finish Care" previously in this section.

Interior Care

To prevent dirt particle abrasions, regularly clean the vehicle's interior. Immediately remove any soiling. Newspapers or dark garments can transfer colour to the vehicle's interior.

Use a soft bristle brush to remove dust from knobs and crevices on the instrument cluster. Using a mild soap solution, immediately remove

hand lotions, sunscreen, and insect repellent from all interior surfaces or permanent damage may result.

Use cleaners specifically designed for the surfaces being cleaned to prevent permanent damage. Apply cleaners directly to the cleaning cloth. Do not spray cleaners on any switches or controls. Remove cleaners quickly.

Before using cleaners, read and follow all safety instructions on the label. While cleaning the interior, open doors and windows to get proper ventilation.

To prevent damage, do not clean the interior using the following cleaners or techniques:

- Never use a razor or any other sharp object to remove a soil from any interior surface.
- Never use a brush with stiff bristles.
- Never rub any surface aggressively or with pressure.

- Do not use laundry detergents or dishwashing soaps with degreasers. For liquid cleaners, use approximately 20 drops per 3.8 L (1 gal) of water. A concentrated soap solution will create streaks and attract dirt. Do not use solutions that contain strong or caustic soap.
- Do not heavily saturate the upholstery when cleaning.
- Do not use solvents or cleaners containing solvents.

Interior Glass

To clean, use a terry cloth fabric dampened with water. Wipe droplets left behind with a clean dry cloth. If necessary, use a commercial glass cleaner after cleaning with plain water.

Caution

To prevent scratching, never use abrasive cleaners on automotive glass. Abrasive cleaners or aggressive cleaning may damage the rear window defogger.

Cleaning the windscreen with water during the first three to six months of ownership will reduce tendency to fog.

Speaker Covers

Vacuum around a speaker cover gently, so that the speaker will not be damaged. Clean spots with water and mild soap.

Coated Mouldings

Coated mouldings should be cleaned.

- When lightly soiled, wipe with a sponge or soft, lint-free cloth dampened with water.
- When heavily soiled, use warm soapy water.

Fabric/Carpet/Suede/ Sueded-Microfiber

Start by vacuuming the surface using a soft brush attachment. If a rotating vacuum brush attachment is being used, only use it on the floor carpet. Before cleaning, gently remove as much of the soil as possible:

- Gently blot liquids with a paper towel. Continue blotting until no more soil can be removed.
- For solid soil, remove as much as possible prior to vacuuming.

To clean:

1. Saturate a clean, lint-free colour-fast cloth with water. Microfiber cloth is recommended to prevent lint transfer to the fabric or carpet.
2. Remove excess moisture by gently wringing until water does not drip from the cleaning cloth.
3. Start on the outside edge of the soil and gently rub toward the centre. Fold the cleaning cloth

to a clean area frequently to prevent forcing the soil in to the fabric.

4. Continue gently rubbing the soiled area until there is no longer any colour transfer from the soil to the cleaning cloth.
5. If the soil is not completely removed, use a mild soap solution followed only by plain water.

If the soil is not completely removed, it may be necessary to use a commercial upholstery cleaner or spot lifter. Test a small hidden area for colourfastness before using a commercial upholstery cleaner or spot lifter. If ring formation occurs, clean the entire fabric or carpet.

After cleaning, use a paper towel to blot excess moisture.

Cleaning High Gloss Surfaces and Vehicle Information and Radio Displays

Use a microfibre cloth on high gloss surfaces or vehicle displays. First, use a soft bristle brush to remove

dirt that can scratch the surface. Then gently clean by rubbing with a microfibre cloth. Never use window cleaners or solvents. Periodically hand wash the microfibre cloth separately, using mild soap. Do not use bleach or fabric softener. Rinse thoroughly and air dry before next use.

Caution

Do not attach a device with a suction cup to the display. This may cause damage and would not be covered by the vehicle warranty.

Instrument Panel, Leather, Vinyl, Other Plastic Surfaces, Low Gloss Paint Surfaces, and Natural Open Pore Wood Surfaces

Use a soft microfiber cloth dampened with water to remove dust and loose dirt. For a more thorough cleaning, use a soft microfiber cloth dampened with a mild soap solution.

Caution

Soaking or saturating leather, especially perforated leather, as well as other interior surfaces, may cause permanent damage. Wipe excess moisture from these surfaces after cleaning and allow them to dry naturally. Never use heat, steam, or spot removers. Do not use cleaners that contain silicone or wax-based products. Cleaners containing these solvents can permanently change the appearance and feel of leather or soft trim, and are not recommended.

Do not use cleaners that increase gloss, especially on the instrument panel. Reflected glare can decrease visibility through the windshield under certain conditions.

Caution

Use of air fresheners may cause permanent damage to plastics and painted surfaces. If an air freshener comes in contact with any plastic or painted surface in the vehicle, blot immediately and clean with a soft cloth dampened with a mild soap solution. Damage caused by air fresheners would not be covered by the vehicle warranty.

Cargo Cover and Convenience Net

Wash with warm water and mild detergent. Do not use chlorine bleach. Rinse with cold water, and then dry completely.

Care of Safety Belts

Keep belts clean and dry.

 **Warning**

Do not bleach or dye safety belts. It may severely weaken them. In a crash, they might not be able to provide adequate protection. Clean safety belts only with mild soap and lukewarm water.

Floor Mats **Warning**

If a floor mat is the wrong size or is not properly installed, it can interfere with the pedals. Interference with the pedals can cause unintended acceleration and/or increased stopping distance which can cause a crash and injury. Make sure the floor mat does not interfere with the pedals.

Use the following guidelines for proper floor mat usage:

- The original equipment floor mats were designed for your vehicle. If the floor mats need replacing, it is recommended that GM certified floor mats be purchased. Non-GM floor mats may not fit properly and may interfere with the accelerator or brake pedal. Always check that the floor mats do not interfere with the pedals.
- Do not use a floor mat if the vehicle is not equipped with a floor mat retainer on the driver side floor.
- Use the floor mat with the correct side up. Do not turn it over.
- Do not place anything on top of the driver side floor mat.
- Use only a single floor mat on the driver side.
- Do not place one floor mat on top of another.

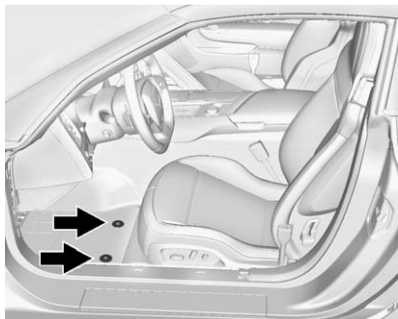

The floor mats are held in place by two retainers.

Installing and Replacing the Floor Mats

1. Pull up on the rear of the floor mat to remove it from the retainers.
2. Reinstall by lining up the openings in the floor mat over the retainers and push down into position.
3. Make sure the floor mat is properly secured in place. Verify the floor mat does not interfere with the pedals.

Service and Maintenance

General Information
 General Information 283

Scheduled Maintenance
 Scheduled Maintenance 283

Recommended Fluids, Lubricants, and Parts
 Recommended Fluids and Lubricants 286
 Maintenance Replacement Parts 287

Maintenance Records
 Maintenance Records 289

General Information

It is essential that your vehicle receives the maintenance outlined on the following pages to retain the safety, reliability and performance originally built into your vehicle.

When your odometer reaches the mileage indicated on the following pages, or the corresponding time interval has been reached, take your vehicle, preferably to an authorised dealer and/or repairer, who will provide the proper parts and service.

Once maintenance has been performed, have the authorised dealer and/or repairer fill out and stamp the appropriate box in this booklet to serve as your maintenance record which may be needed for warranty repairs. It will also show future owners how well your vehicle has been maintained.

Scheduled Maintenance

Engine Oil Change

When the CHANGE ENGINE OIL SOON message displays, have the engine oil and filter changed within the next 1,000 km/600 mi. If driven under the best conditions, the engine oil life system may not indicate the need for vehicle service for up to a year. The engine oil and filter must be changed at least once a year and the oil life system must be reset. Your trained dealer technician can perform this work. If the engine oil life system is reset accidentally, service the vehicle within 5,000 km/3,000 mi since the last service. Reset the oil life system when the oil is changed.

Additional Maintenance At 800 km

Dry Sump Engines Only (Z51 and Z06) - Required: Initial break-in oil change. Change engine oil and filter after the first 800 km/500 mi.

Follow the engine oil life system for every oil change thereafter.

Inspection Every 15 000 km or 1 Year

- Change engine oil and filter. Reset oil life system.
- Engine coolant level check. See *Engine Coolant* ⇨ 222.
- Engine cooling system inspection. Visual inspection of hoses, pipes, fittings, and clamps and replacement, if needed.
- Windscreen washer fluid level check.
- Windscreen wiper blade inspection for wear, cracking, or contamination and windscreen and wiper blade

cleaning, if contaminated. Worn or damaged wiper blade replacement.

- Tyre inflation pressures check.
- Tyre wear inspection.
- Fluids visual leak check. A leak in any system must be repaired and the fluid level checked.
- Engine air cleaner filter inspection. See *Engine Air Cleaner/Filter* ⇨ 218.
- Brake system inspection. See *Exterior Care* ⇨ 273.
- Steering and suspension inspection. Visual inspection for damaged, loose, or missing parts or signs of wear.
- Body hinges and latches, key lock cylinders, folding seat hardware, and rear compartment, bonnet, and console door hinges and latches lubrication. More frequent lubrication may be required when the vehicle is exposed to a corrosive environment. Applying silicone grease on weatherstrips

with a clean cloth makes them last longer, seal better, and not stick or squeak.

- Restraint system component check.
- Fuel system inspection for damage or leaks.
- Exhaust system and nearby heat shields inspection for loose or damaged components.
- Accelerator pedal check for damage, high effort, or binding.
- Bonnet/Deck lid/Tailgate/Lift glass Support Gas Strut Service: Visually inspect gas strut, if equipped, for signs of wear, cracks, or other damage. Check the hold open ability of the gas strut. Contact your authorised repairer if service is required.
- Road Test. Check all systems for correct function/performance.
- To maintain air conditioning efficiency, have an authorised repairer check the system at least once each year.
- Underbody flushing service.

- Tyre sealant and compressor kit (if equipped with tyre sealant and compressor kit), check sealant expiration date.

Additional Maintenance Every 30 000 km or 2 Years

In addition to the items listed under “Inspection Every 15 000 km or 1 year” the following items should be carried out every 30 000 km or 2 years (whichever occurs first):

- Passenger compartment air filter — replace. More frequent replacement may be needed if the vehicle is driven in areas with heavy traffic, poor air quality, areas with high dust levels or are sensitive to environmental allergens. Filter replacement may also be needed if you notice reduced airflow, windows misting up, or odours. Your local GM Service location can help you determine when it is the right time to replace your filter.

- Engine air filter replacement. If driving in dusty conditions, inspect the filter at each oil change or more often as needed.

Additional Maintenance Every 60 000 km or 2 Years

- Replace brake fluid.
- Replace clutch fluid (if equipped with manual gearbox).

Additional Maintenance Every 72 000 km

- Rear axle fluid change.
- Automatic transmission fluid change (severe operation).
- Manual gearbox fluid change (severe operation).

Additional Maintenance Every 96 000 km

- Spark plugs — replace (LT4 Supercharged Engine).

Additional Maintenance Every 150 000 km

- Spark plugs — replace (LT1 Engine).

Additional Maintenance Every 240 000 km

- Engine cooling system drain and refill (or every 5 years, whichever occurs first).

Conditions Requiring More Frequent Maintenance (Severe Service)

- Extreme temperatures.
- Heavy city traffic.
- Hilly or mountainous terrain.
- Dusty, muddy, or off-road conditions.
- Commercial use.
- Most trips less than 6 km.

Recommended Fluids, Lubricants, and Parts

Recommended Fluids and Lubricants

Fluids and lubricants identified below by name, part number or specification can be obtained from your dealer.

Usage	Fluid/Lubricant
Engine Oil	Engine oil meeting the dexos2™ specification of the proper SAE viscosity grade. AC Delco dexos2 Synthetic Blend is recommended. For track events or competitive driving, Mobil 1® engine oil is recommended. See <i>Engine Oil</i> ⇨ 211.
Engine Coolant	40/60 coolant/water mixture of clean, drinkable water and use only DEX-COOL® coolant. See <i>Engine Coolant</i> ⇨ 222.
Hydraulic Brake System	DOT 3 Hydraulic Brake Fluid (GM Part No. 19299818).
Hydraulic Clutch System	Hydraulic Clutch Fluid. Use only GM Part No. 19299570, DOT 4 brake fluid.
Automatic Transmission	DEXRON®-HP Automatic Transmission Fluid (GM Part No. 19300536)
Manual Gearbox	Manual Gearbox Oil (GM Part No. 88861800).
Windscreen Washer	Automotive windscreen washer fluid that meets regional freeze protection requirements.
Chassis Lubrication and Parking Brake Cable Guides	Chassis Lubricant (GM Part No. 12377985) or lubricant meeting requirements of NLGI #2, Category LB or GC-LB.
Key Lock Cylinders, Bonnet, and Door Hinges	Multi-Purpose Lubricant, Superlube (GM Part No. 12346241).

Usage	Fluid/Lubricant
Rear Axle	DEXRON® LS Gear Oil. (GM Part No. 88862624) See <i>Rear Axle</i> ⇨ 233 for information on checking the fluid.
Electronic Limited Slip Differential (eLSD) Clutch System Lubricant (Z51 and Z06 Only)	DEXRON®-VI Automatic Transmission Fluid.
Bonnet Latch Assembly, Secondary Latch, Pivots, Spring Anchor and Release Pawl	Lubriplate Lubricant Aerosol (GM Part No. 89021668) or lubricant meeting requirements of NLGI #2, Category LB or GC-LB.
Weatherstrip Conditioning	Weatherstrip Lubricant (GM Part No. 3634770) or Dielectric Silicone Grease (GM Part No. 12345579).
All: Weatherstrip	Synthetic Grease with Teflon, Superlube (GM Part No. 12371287).

Maintenance Replacement Parts

Replacement parts identified below by name, part number, or specification can be obtained from your dealer.

Part	GM Part Number	ACDelco Part Number
Engine Air Cleaner/Filter	23107355	A3191C
Engine Oil Filter	12640445	PF64
Passenger Compartment Air Filter Element	22862632	CF139
Spark Plugs		
6.2L LT1 Engine	12622441	41-114

Part	GM Part Number	ACDelco Part Number
6.2L LT4 Supercharged Engine	12642722	41-128
Wiper Blades		
Driver Side — 550 mm (21.7 in)	22756331	-
Passenger Side — 500 mm (19.7 in)	22756330	-

Technical Data

Vehicle Identification

Vehicle Identification Number (VIN)	290
Service Parts Identification Label	290

Vehicle Data

Capacities and Specifications	291
Engine Drive Belt Routing	294

Vehicle Identification

Vehicle Identification Number (VIN)



This legal identifier is in the front corner of the instrument panel, on the left side of the vehicle. It can be seen through the windshield from outside. The VIN also appears on the Vehicle Certification and Service Parts labels and certificates of title and registration.

Engine Identification

The eighth character in the VIN is the engine code. This code identifies the vehicle's engine, specifications, and replacement parts. See “Engine Specifications” under *Capacities and Specifications* ⇨ 291 for the vehicle's engine code.

Service Parts Identification Label

This label, under the carpet in the hatch/boot area on the passenger side, has the following information:

- Vehicle Identification Number (VIN).
- Model designation.
- Paint information.
- Production options and special equipment.

Do not remove this label from the vehicle.

Vehicle Data

Capacities and Specifications

The following approximate capacities are given in metric and English conversions.

See *Recommended Fluids and Lubricants* ⇨ 286.

Application	Capacities	
	Metric	English
Air Conditioning Refrigerant	For the air conditioning system refrigerant charge type and amount, see the refrigerant label under the bonnet. See your dealer for more information.	
Cooling System	11.2 L	11.8 qt
Intercooler System (LT4)	4.3 L	4.5 qt
Engine Oil with Filter		
6.2L LT1 Engine With Z51	9.3 L	9.8 qt
6.2L LT4	9.3 L	9.8 qt
Fuel Tank	70.3 L	18.5 gal
Wheel Nut Torque	140 N•m	100 lb ft
All capacities are approximate. When adding, be sure to fill to the approximate level, as recommended in this manual. Recheck fluid level after filling		

Engine Specifications

Engine	VIN Code	Transmission	Spark Plug Gap	Firing Order
6.2L V8 LT1	7	Automatic	0.950–1.100 mm (0.037–0.043 in)	1-8-7-2-6-5-4-3
6.2L V8 LT4	6	Automatic Manual	0.725–0.875 mm (0.029–0.034 in)	1-8-7-2-6-5-4-3

Engine Data

Engine	Horsepower	Torque	Displacement	Compression Ratio
6.2L V8 LT1	343 kW (460 hp) @6000 min ⁻¹	630 N•m (465 lb ft) @4600 min ⁻¹	6.2L	11.5:1
6.2L V8 LT4	485 kW (650 hp) @6400 min ⁻¹	881 N•m (650 lb ft) @3600 min ⁻¹	6.2L	10.0:1

Fuel Consumption and Emissions Information

	Urban	Extra-Urban	Combined
Coupe with LT1			
Carbon Dioxide (g/km)	445	189	284
Fuel Economy (L/100 km)	19.5	8.3	12.4

	Urban	Extra-Urban	Combined
Convertible with LT1			
Carbon Dioxide (g/km)	440	189	282
Fuel Economy (L/100 km)	19.2	8.2	12.3
LT4 with Manual Gearbox			
Carbon Dioxide (g/km)	425	213	291
Fuel Economy (L/100 km)	18.6	9.3	12.7
LT4 with Automatic Transmission			
Carbon Dioxide (g/km)	505	217	322
Fuel Economy (L/100 km)	22.0	9.5	14.1

Engine Drive Belt Routing

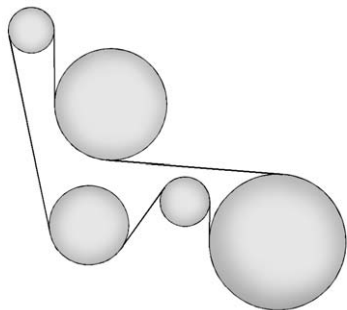

6.2L LT1 Engine

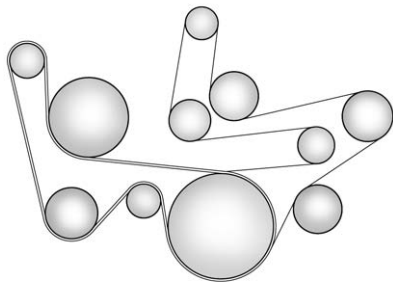

6.2L LT4 Engine

Customer Information

Customer Information

Radio Frequency Identification (RFID)	295
Declaration of Conformity	295

Vehicle Data Recording and Privacy

Vehicle Data Recording and Privacy	296
Infotainment System	296

Customer Information

Radio Frequency Identification (RFID)

Radio Frequency Identification (RFID) technology is used in some vehicles for functions such as tyre pressure monitoring and ignition system security. It is also used in connection with conveniences such as Remote Keyless Entry (RKE) transmitters for remote door locking/unlocking and starting, and in-vehicle transmitters for garage door openers. RFID technology in Corvette vehicles does not use or record personal information or link with any other Corvette system containing personal information.

Declaration of Conformity

This vehicle has systems that transmit and/or receive radio waves subject to Directive 1999/5/EC. These systems are in compliance with the essential requirements and other relevant provisions of Directive 1999/5/EC. Copies of the original Declarations of Conformity can be obtained on our website.

Vehicle Data Recording and Privacy

Event Data Recorders

Data Storage Modules in the Vehicle

A large number of electronic components of your vehicle contain data storage modules temporarily or permanently storing technical data about the condition of the vehicle, events, and errors. In general, this technical information documents the condition of parts, modules, systems, or the environment:

- Operating conditions of system components (e.g., filling levels).
- Status messages of the vehicle and its single components (e.g., number of wheel revolutions/rotational speed, deceleration, lateral acceleration).
- Dysfunctions and defects in important system components.

- Vehicle reactions in particular driving situations (e.g., inflation of an airbag, activation of the stability regulation system).
- Environmental concerns (e.g., temperature).

This data is exclusively technical and helps identify and correct errors as well as optimise vehicle functions.

Motion profiles indicating travelled routes cannot be created with this data.

If services are used (e.g., repair works, service processes, warranty cases, quality assurance), employees of the service network (manufacturer included) are able to read out this technical information from the event and error data storage modules applying special diagnostic devices. If required, you will receive further information at these dealers. After an error has been corrected, the data is deleted from the error storage module or constantly overwritten.

When using the vehicle, situations may occur in which this technical data related to other information (accident report, damages on the vehicle, witness statements, etc.) may be associated with a specific person — possibly, with the assistance of an expert.

Additional functions contractually agreed upon with the client (e.g., vehicle location in emergency cases) allow the transmission of particular vehicle data from the vehicle.

Infotainment System

If the vehicle is equipped with a navigation system as part of the infotainment system, use of the system may result in the storage of destinations, addresses, telephone numbers, and other trip information. See the infotainment manual for information on stored data and for deletion instructions.

Index

A

- Accessories and Modifications 203
- Accessory Power 171
- Active Fuel Management® 173
- Active Rev Match 181
- Add-On Electrical Equipment ... 201
- Adjustments
 - Lumbar, Front Seats 53
- Air Cleaner/Filter, Engine 218
- Air Dam, Front 167
- Air Filter, Passenger
 - Compartment 149
- Air Vents 148
- Airbag System
 - Check 73
 - How Does an Airbag Restrain? 67
 - Passenger Sensing System ... 68
 - What Makes an Airbag Inflate? 67
 - What Will You See after an Airbag Inflates? 67
 - When Should an Airbag Inflate? 66
 - Where Are the Airbags? 65
- Airbags
 - Adding Equipment to the Vehicle 73
 - Passenger Status Indicator ... 102
 - Readiness Light 102
 - Servicing Airbag-Equipped Vehicles 72
 - System Check 64
- Alarm
 - Vehicle Security 36
- Anti-theft
 - Locking System 38
- Antilock Brake System (ABS) ... 182
 - Warning Light 107
- Appearance Care
 - Exterior 273
 - Interior 278
- Assistance Systems for Parking and Reversing 196
- Automatic
 - Dimming Mirrors 40
 - Door Locks 33
 - Headlamp System 135
 - Transmission 175
 - Transmission Fluid 217
- Automatic Transmission
 - Manual Mode 176

Automatic Transmission (cont'd)			
Shift Lock Control Function			
Check	234		
Axle, Rear	233		
B			
Battery	228		
Exterior Lighting Battery			
Saver	138		
Jump Starting	269		
Power Protection	138		
Voltage and Charging			
Messages	117		
Blade Replacement, Wiper	235		
Bonnet	207		
Brake			
Parking, Electric	182		
System Warning Light	105		
Brakes	226		
Antilock	182		
Assist	184		
Fluid	227		
System Messages	117		
Braking	152		
Bulb Replacement	237		
Headlamp Aiming	236		
Headlamps	236		
High Intensity Discharge (HID) Lighting	236		
Bulb Replacement (cont'd)			
Number Plate Lamps	237		
Buying New Tyres	256		
C			
Capacities and			
Specifications	291		
Carbon Fibre	167		
Carbon Monoxide			
Engine Exhaust	174		
Hatch	34		
Winter Driving	161		
Cargo			
Cover	88		
Cargo Net	89		
Caution, Danger, and Warning	2		
Centre Console Storage	88		
Chains, Tyre	260		
Charging System Light	103		
Check			
Malfunction Indicator			
Engine Light	104		
Child Restraints			
Infants and Young Children	76		
ISOFIX	83		
Older Children	74		
Securing	83		
Systems	78		
Cleaning			
Exterior Care	273		
Interior Care	278		
Climate Control Systems			
Dual Automatic	145		
Clock	93		
Cluster, Instrument	95		
Clutch, Hydraulic	217		
Compartments			
Storage	86		
Compass			
Messages	117		
Competition Oriented Tires	248		
Competitive Driving Mode	190		
Compressor Kit, Tyre			
Sealant	262		
Conformity			
Declaration of	295		
Control			
Traction and Electronic			
Stability	185		
Control of a Vehicle	151		
Convenience Net	89		
Convertible Top	46		
Messages	117		
Convex Mirrors	39		
Coolant			
Engine	222		

Coolant (cont'd)		Electrical System
Engine Temperature Gauge .. 101		Engine Compartment Fuse
Engine Temperature		Block 238
Warning Light 108		Fuses 238
Cooling System 220, 221		Overload 238
Engine Messages 119		Rear Compartment Fuse
Courtesy Lamps 137		Block 242
Cover		Electronic Stability Control
Cargo 88		(ESC) Off Light 108
Cruise Control 193		Engine
Light 111		Air Cleaner/Filter 218
Messages 119		Check and Service Engine
Cupholders 87		Soon Light 104
D		Compartment Overview 208
Danger, Warning, and Caution 2		Coolant 222
Data Recorder		Coolant Temperature
Performance 139		Gauge 101
Daytime Running		Coolant Temperature
Lamps (DRL) 134		Warning Light 108
Declaration of Conformity 295		Cooling System 220, 221
Defensive Driving 151		Cooling System Messages ... 119
Delayed Locking 32		Drive Belt Routing 294
Differential, Limited-Slip 193		Exhaust 174
Distracted Driving 151		Oil Life System 216
Door		Oil Messages 120
Ajjar Light 111		Oil Pressure Light 109
Ajjar Messages 119		Overheating 224
Delayed Locking 32		Power Messages 120
	Door (cont'd)	
	Locks 30	
	Power Locks 32	
	Drive Belt Routing, Engine 294	
	Driver Information	
	Centre (DIC) 111	
	Driver Mode Control 187	
	Driving	
	Competitive 190	
	Defensive 151	
	For Better Fuel Economy 22	
	Hill and Mountain Roads 160	
	If the Vehicle is Stuck 162	
	Loss of Control 153	
	Off-Road Recovery 153	
	Track Events and	
	Competitive 154	
	Vehicle Load Limits 162	
	Wet Roads 159	
	Winter 161	
	Dual Automatic Climate	
	Control System 145	
	E	
	Electric Parking Brake 182	
	Electric Parking Brake Light 106	
	Electrical Equipment,	
	Add-On 201	

- Engine (cont'd)
Running While Parked 174
Starting 169
Entry Lighting 138
Exit Lighting 138
Exterior Lamp Controls 133
Exterior Lamps Off Reminder ... 133
Exterior Lighting Battery
Saver 138
- F**
Features
Memory 12
Filter,
Engine Air Cleaner 218
Flash-to-Pass 134
Flat Tyre 261
Floor Mats 281
Fluid
Automatic Transmission 217
Brakes 227
Washer 225
Fog Lamp Light, Rear 110
Fog Lamps
Rear 136
Folding Mirrors 40
Front Air Dam 167
Front Seats
Heated and Ventilated 56
- Fuel 197
Additives 198
Economy Driving 22
Filling a Portable Fuel
Container 200
Filling the Tank 198
Gauge 100
Low Fuel Warning Light 110
Management, Active 173
System Messages 120
Fuses 238
Engine Compartment Fuse
Block 238
Rear Compartment Fuse
Block 242
- G**
Gauges
Engine Coolant
Temperature 101
Fuel 100
Mileometer 100
Rev Counter 100
Speedometer 100
Trip Odometer 100
Warning Lights and
Indicators 94
Gear Shifting Light 107
- General Information
Service and Maintenance 283
Towing 201
Vehicle Care 203
Glove Box 86
- H**
Hatch 34
Hazard Lights 136
Head Restraints 52
Head-up Display 113
Headlamps
Aiming 236
Automatic 135
Bulb Replacement 236
Daytime Running
Lamps (DRL) 134
Flash-to-Pass 134
High Intensity Discharge
(HID) Lighting 236
Lamps On Reminder 110
Main-Beam On Light 110
Main/Dipped Beam
Changer 134
Washer 92
Heated and Ventilated Front
Seats 56
Heated Mirrors 40
High-Speed Operation 250

Hill and Mountain Roads	160
Hill Start Assist (HSA)	184
Horn	91
How to Wear Safety Belts Properly	59
Hydraulic Clutch	217
I	
Ignition Positions	167
Immobiliser	38
Infants and Young Children, Restraints	76
Infotainment	139
Infotainment System	296
Instrument Cluster	95
Instrument Panel Storage Area	86
Interior Rearview Mirrors	40
Introduction	2
ISOFIX Child Restraint Systems	83
J	
Jump Starting	269
K	
Key and Lock Messages	120
Keyless Entry Remote (RKE) System	25
Keys	23

L	
Lamps	
Courtesy	137
Daytime Running (DRL)	134
Exterior Controls	133
Exterior Lamps Off Reminder	133
Exterior Lighting Battery Saver	138
Malfunction Indicator	104
Messages	121
Number Plate	237
On Reminder	110
Reading	137
Rear Fog	136
Lap-Shoulder Belt	60
Latches, Seat-Back	56
LED Lighting	237
Lifting the Vehicle, Tyres	203
Light	
Electronic Stability Control (ESC), Off	108
Gear Shifting	107
Lighting	
Entry	138
Exit	138
Illumination Control	137
LED	237

Lights	
Airbag Readiness	102
Antilock Brake System (ABS) Warning	107
Brake System Warning	105
Charging System	103
Cruise Control	111
Door Ajar	111
Electric Parking Brake	106
Engine Coolant Temperature Warning	108
Engine Oil Pressure	109
Flash-to-Pass	134
Fog Lamp, Rear	110
Low Fuel Warning	110
Main-Beam On	110
Main/Dipped Beam Changer	134
Seat Belt Reminders	101
Security	110
Service Electric Parking Brake	106
Traction Off	107
Tyre Pressure	109
Lights, Hazard	136
Limited-Slip Differential	193
Locking Systems, Anti-theft	38

- Locks
Automatic Door33
Delayed Locking32
Door30
Lockout Protection33
Power Door32
Loss of Control153
Low Fuel Warning Light110
Low-Profile Tyres247
Lumbar Adjustment53
Front Seats53
- M**
- Main-Beam On Light110
Maintenance
Records289
Maintenance Schedule
Recommended Fluids and
Lubricants286
Scheduled Maintenance283
Malfunction Indicator Lamp104
Manual Gearbox179
Fluid217
Manual Mode176
Matching
Active Rev181
Memory Features12
Memory Seats54
- Messages
Airbag System124
Battery Voltage and
Charging117
Brake System117
Compass117
Convertible Top117
Door Ajar119
Engine Cooling System119
Engine Oil120
Engine Power120
Fuel System120
Key and Lock120
Lamp121
Ride Control System121
Security124
Service Vehicle124
Starting the Vehicle124
Transmission125
Tyre125
Vehicle116
Vehicle Reminder126
Vehicle Speed126
Washer Fluid126
Window126
Mileometer100
Trip100
- Mirrors
Automatic Dimming40
Automatic Dimming
Rearview40
Convex39
Folding40
Heated40
Power39
Tilt in Reverse40
Mirrors, Interior Rearview40
Mode187
Driver Control187
Monitor System, Tyre
Pressure251
- N**
- Net
Cargo89
Net, Convenience89
New Vehicle Run-In166
- O**
- Off-Road
Recovery153
Oil
Engine211
Engine Oil Life System216
Messages120

- Oil (cont'd)
 Pressure Light 109
 Older Children, Restraints 74
 Outlets
 Power 93
 Overheating, Engine 224
- P**
- Panel, Roof 43
 Park
 Shifting Into 171
 Shifting Out of 172
 Parking 172
 Brake and P (Park)
 Mechanism Check 235
 Over Things That Burn 173
 Parking or Reversing
 Assistance Systems 196
 Passenger Airbag Status
 Indicator 102
 Passenger Compartment Air
 Filter 149
 Passenger Sensing System 68
 Performance Data
 Recorder (PDR) 139
 Personalisation
 Vehicle 127
 Power
 Door Locks 32
- Power (cont'd)
 Mirrors 39
 Outlets 93
 Protection, Battery 138
 Retained Accessory (RAP) ... 171
 Seat Adjustment 53
 Windows 41
 Pregnancy, Using Safety Belts ... 62
 Privacy
 Vehicle Data Recording 296
- R**
- Radio Frequency
 Identification (RFID) 295
 Reading Lamps 137
 Rear Axle 233
 Rear Fog Lamp Light 110
 Rear Fog Lamps 136
 Rear Storage 87
 Rearview Mirrors
 Automatic Dimming 40
 Reclining Seat Backrests 54
 Recommended Fluids and
 Lubricants 286
 Records
 Maintenance 289
 Recreational Vehicle Towing ... 273
 Remote Keyless Entry
 (RKE) System 24, 25
- Remote Vehicle Start 29
 Replacement Bulbs 237
 Replacement Parts
 Airbags 74
 Maintenance 287
 Replacing Airbag System 74
 Replacing Safety Belt System
 Parts after a Crash 63
 Restraints
 Where to Put 79
 Retained Accessory
 Power (RAP) 171
 Rev Counter 100
 Reverse Tilt Mirrors 40
 Ride Control Systems
 Enhanced Traction
 System (ETS) 193
 Messages 121
 Roads
 Driving, Wet 159
 Roof Panel 43
 Rotation, Tyres 254
 Routing, Engine Drive Belt 294
 Run-Flat Tyres 246
 Running the Vehicle While
 Parked 174
 Running-In, New Vehicle 166

S

Safety Belts	58
Care	63
How to Wear Safety Belts Properly	59
Lap-Shoulder Belt	60
Replacing after a Crash	63
Use During Pregnancy	62
Safety System Check	62
Scheduled Maintenance	283
Sealant Kit, Tyre	262
Seat Belts	
Reminders	101
Seat-Back Latches	56
Seats	
Head Restraints	52
Heated and Ventilated Front	56
Lumbar Adjustment, Front	53
Memory	54
Power Adjustment, Front	53
Reclining Seat Backrests	54
Securing Child Restraints	83
Security	
Light	110
Messages	124
Vehicle	36
Vehicle Alarm	36

Service

Accessories and Modifications	203
Doing Your Own Work	206
Engine Soon Light	104
Maintenance Records	289
Maintenance, General Information	283
Parts Identification Label	290
Vehicle Messages	124
Service Electric Parking Brake Light	106
Servicing the Airbag	72
Shift Lock Control Function Check, Automatic Transmission	234
Shifting	
Into Park	171
Out of Park	172
Signals, Turn and Lane-Change	136
Specifications and Capacities	291
Speedometer	100
Start Assist, Hills	184
Start Vehicle, Remote	29
Starter Switch Check	234
Starting the Engine	169

Starting the Vehicle

Messages	124
Steering	152
Wheel Adjustment	91
Wheel Controls	91
Storage	
Rear	87
Storage Areas	
Cargo Cover	88
Centre Console	88
Convenience Net	89
Glove Box	86
Instrument Panel	86
Storage Compartments	86
Storing the Tyre Sealant and Compressor Kit	269
Stuck Vehicle	162
Summer Tyres	248
Sun Visors	43
Symbols	2
System	
Infotainment	139, 296

T

Theft-Deterrent Systems	38
Immobiliser	38
Time	93
Towing	
General Information	201

Towing (cont'd)	
Recreational Vehicle	273
Vehicle	272
Track Events and Competitive Driving	154
Traction	
Limited-Slip Differential	193
Off Light	107
Traction Control/Electronic Stability Control	185
Transmission	
Automatic	175
Fluid, Automatic	217
Fluid, Manual	217
Messages	125
Trip Odometer	100
Turn and Lane-Change Signals	136
Tyres	245
Buying New Tyres	256
Chains	260
Competition Oriented	248
Different Size	258
If a Tyre Goes Flat	261
Inspection	254
Lifting the Vehicle	203
Low Profile	247
Messages	125

Tyres (cont'd)	
Pressure	250
Pressure Light	109
Pressure Monitor Operation ..	252
Pressure Monitor System	251
Rotation	254
Run-Flat	246
Sealant and Compressor Kit	262
Sealant and Compressor Kit, Storing	269
Wheel Alignment and Tyre Balance	258
Wheel Replacement	259
When It Is Time for New Tyres	256
Winter	246

U

Using This Manual	2
-------------------------	---

V

Vehicle	
Alarm System	36
Control	151
Identification Number (VIN) ...	290
Load Limits	162
Messages	116
Personalisation	127

Vehicle (cont'd)	
Reminder Messages	126
Remote Start	29
Security	36
Speed Messages	126
Towing	272
Vehicle Care	
Storing the Tyre Sealant and Compressor Kit	269
Tyre Pressure	249
Vehicle Data Recording and Privacy	296
Ventilation, Air	148
Visors	43

W

Warning	
Brake System Light	105
Caution and Danger	2
Warning Lights, Gauges, and Indicators	94
Warnings	
Hazard Lights	136
Washer Fluid	225
Messages	126
Washer, Headlamps	92
Wheels	
Alignment and Tyre Balance	258

Wheels (cont'd)	
Different Size	258
Replacement	259
When It Is Time for New	
Tyres	256
Where to Put the Restraint	79
Windows	41
Messages	126
Power	41
Windscreen	
Replacement	236
Wiper/Washer	91
Winter	
Driving	161
Winter Tyres	246
Wiper Blade Replacement	235